

Description

The HSU3119 is the high cell density trenched P-ch MOSFETs, which provide excellent RDSON and gate charge for most of the synchronous buck converter applications.

The HSU3119 meet the RoHS and Green Product requirement, 100% EAS guaranteed with full function reliability approved.

- Super Low Gate Charge
- 100% EAS Guaranteed
- Green Device Available
- Excellent CdV/dt effect decline
- Advanced high cell density Trench technology

Product Summary

V_{DS}	-30	V
$R_{DS(ON),Max}$	3.0	m Ω
I_D	-130	A

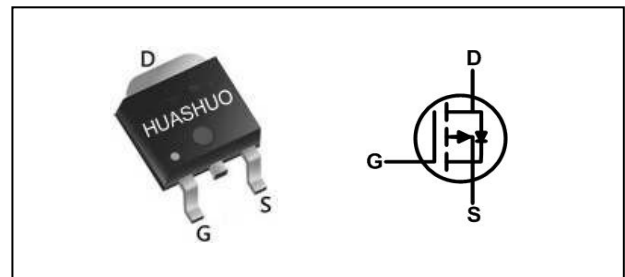
TO-252 Pin Configuration

Absolute Maximum Ratings

Symbol	Parameter	Rating	Units
V_{DS}	Drain-Source Voltage	-30	V
V_{GS}	Gate-Source Voltage	± 20	V
$I_D@T_C=25^\circ C$	Continuous Drain Current, $V_{GS} @ -10V^{1,6}$	-130	A
$I_D@T_C=100^\circ C$	Continuous Drain Current, $V_{GS} @ -10V^{1,6}$	-81	A
I_{DM}	Pulsed Drain Current ²	-510	A
EAS	Single Pulse Avalanche Energy ³	1050	mJ
I_{AS}	Avalanche Current	-75	A
$P_D@T_C=25^\circ C$	Total Power Dissipation ⁴	135	W
T_{STG}	Storage Temperature Range	-55 to 150	$^\circ C$
T_J	Operating Junction Temperature Range	-55 to 150	$^\circ C$

Thermal Data

Symbol	Parameter	Typ.	Max.	Unit
$R_{\theta JA}$	Thermal Resistance Junction-ambient ¹ ($t \leq 10S$)	---	20	$^\circ C/W$
	Thermal Resistance Junction-ambient ¹ (Steady State)	---	60	$^\circ C/W$
$R_{\theta JC}$	Thermal Resistance Junction-case ¹	---	1.8	$^\circ C/W$

Electrical Characteristics ($T_J=25\text{ }^\circ\text{C}$, unless otherwise noted)

Symbol	Parameter	Conditions	Min.	Typ.	Max.	Unit
BV_{DSS}	Drain-Source Breakdown Voltage	$V_{GS}=0V, I_D=-250\mu A$	-30	---	---	V
$R_{DS(ON)}$	Static Drain-Source On-Resistance ²	$V_{GS}=-10V, I_D=-30A$	---	---	3.0	$m\Omega$
		$V_{GS}=-4.5V, I_D=-20A$	---	---	4.2	$m\Omega$
$V_{GS(th)}$	Gate Threshold Voltage	$V_{GS}=V_{DS}, I_D=-250\mu A$	-1.0	---	-2.5	V
I_{DSS}	Drain-Source Leakage Current	$V_{DS}=-30V, V_{GS}=0V, T_J=25^\circ C$	---	---	-1	μA
		$V_{DS}=-30V, V_{GS}=0V, T_J=125^\circ C$	---	---	-100	μA
I_{GSS}	Gate-Source Leakage Current	$V_{GS}=\pm 20V, V_{DS}=0V$	---	---	± 100	nA
R_g	Gate resistance	$V_{DS}=0V, V_{GS}=0V, f=1MHz$		1.8		Ω
Q_g	Total Gate Charge (-10V)	$V_{DS}=-15V, V_{GS}=-10V, I_D=-20A$	---	210	---	nC
Q_{gs}	Gate-Source Charge		---	2.2	---	
Q_{gd}	Gate-Drain Charge		---	3.3	---	
$T_{d(on)}$	Turn-On Delay Time	$V_{DD}=-15V, V_{GS}=-10V, R_G=3\Omega, I_D=-10A$	---	17	---	ns
T_r	Rise Time		---	6	---	
$T_{d(off)}$	Turn-Off Delay Time		---	21	---	
T_f	Fall Time		---	39	---	
C_{iss}	Input Capacitance	$V_{DS}=-15V, V_{GS}=0V, f=1MHz$	---	12700	---	pF
C_{oss}	Output Capacitance		---	1380	---	
C_{rss}	Reverse Transfer Capacitance		---	1210	---	

Diode Characteristics

Symbol	Parameter	Conditions	Min.	Typ.	Max.	Unit
I_S	Continuous Source Current ^{1,5}	$V_G=V_D=0V$, Force Current	---	---	-130	A
V_{SD}	Diode Forward Voltage ²	$V_{GS}=0V, I_S=-20A, T_J=25^\circ C$	---	---	-1.2	V
t_{rr}	Reverse Recovery Time	$I_F=-20A, di/dt=100A/\mu s,$	---	37	---	nS
Q_{rr}	Reverse Recovery Charge	$T_J=25^\circ C$	---	30	---	nC

Note :

- 1.The data tested by surface mounted on a 1 inch² FR-4 board with 2OZ copper.
- 2.The data tested by pulsed , pulse width $\leq 300\mu s$, duty cycle $\leq 2\%$
- 3.The EAS data shows Max. rating . The test condition is $V_{DD}=-30V, V_{GS}=-10V, L=0.5mH, I_{AS}=-75A$
- 4.The power dissipation is limited by 150 $^\circ C$ junction temperature
- 5.The data is theoretically the same as I_D and I_{DM} , in real applications , should be limited by total power dissipation
- 6.The maximum current rating is package limited.

Typical Characteristics

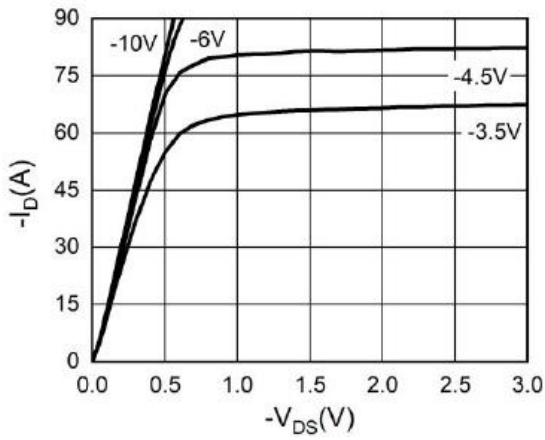

Fig.1 Output Characteristics

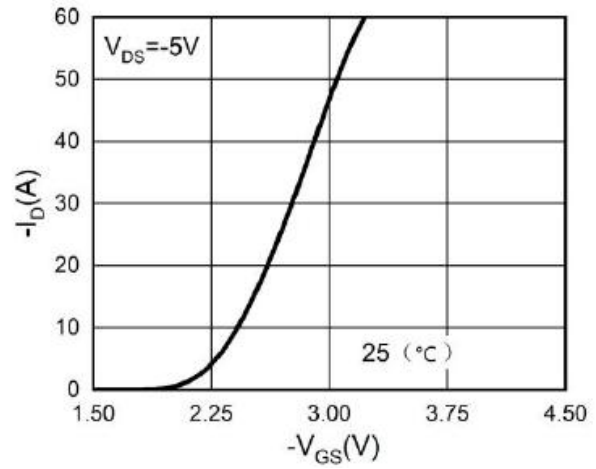

Fig.2 Transfer Characteristics

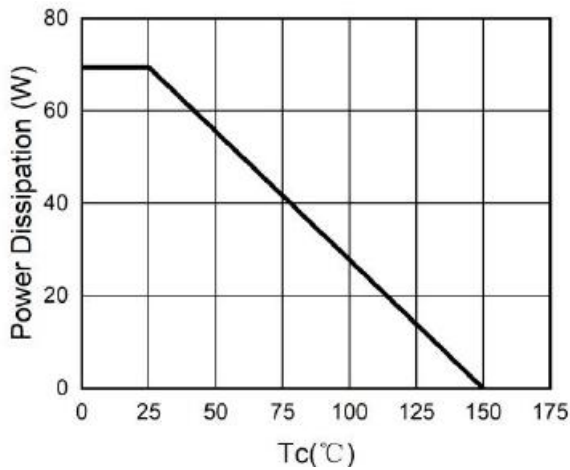

Fig.3 Power Dissipation

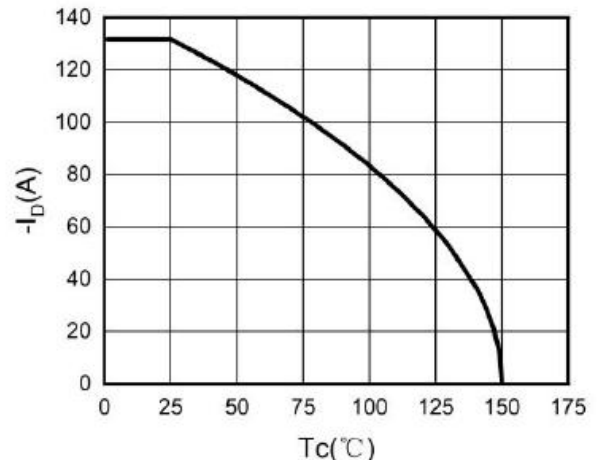

Fig.4 Drain Current

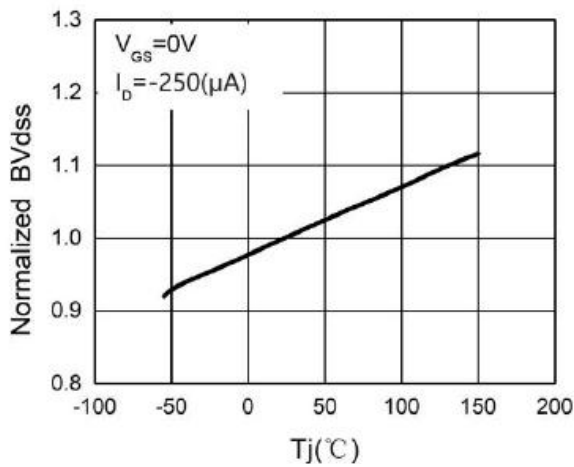

Fig.5 BV_{DSS} vs Junction Temperature

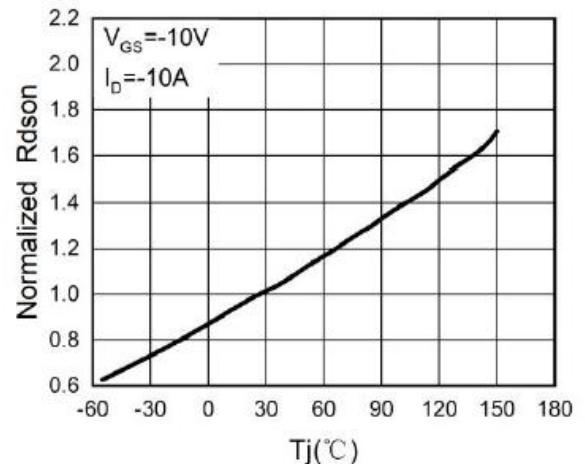

Fig.6 $R_{DS(on)}$ vs Junction Temperature

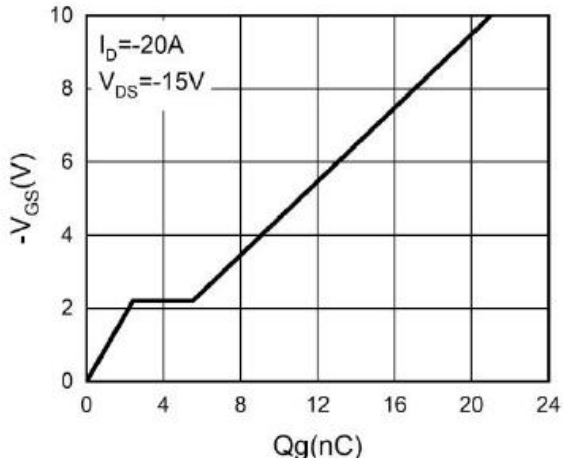

Fig.7 Gate Charge Waveforms

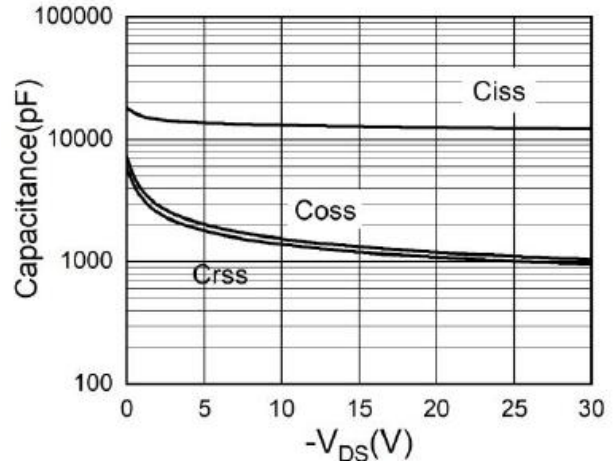

Fig.8 Capacitance

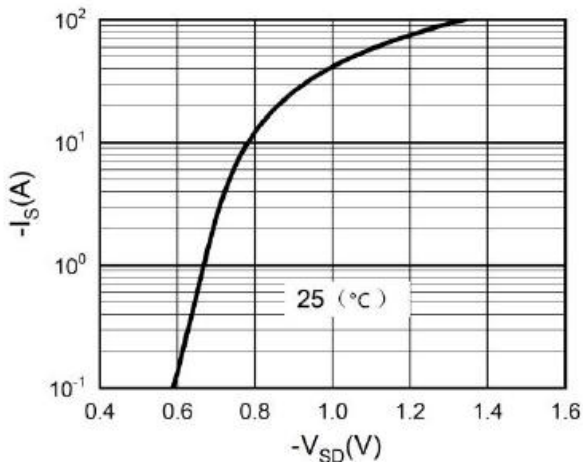

Fig.9 Body-Diode Characteristics

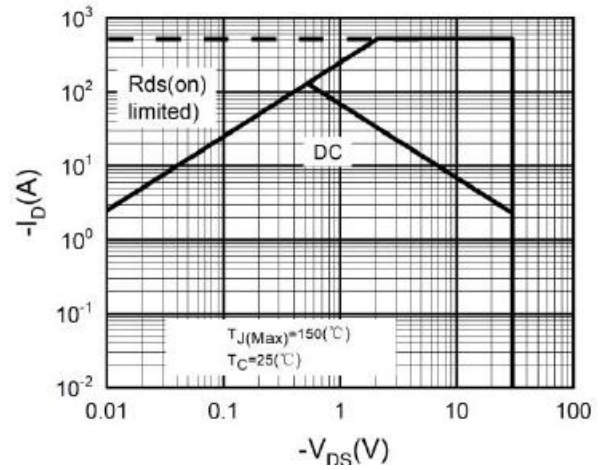
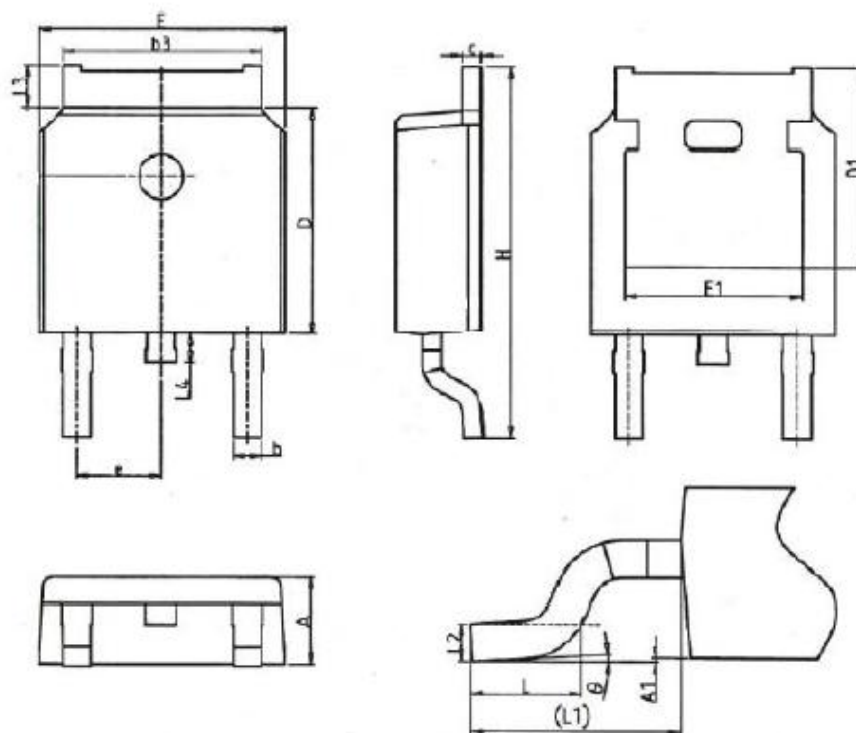

Fig.10 Maximum Safe Operating Area



TO252-2L Package Outline



SYMBOLS	MILLIMETERS		INCHES	
	MIN	MAX	MIN	MAX
A	2.18	2.40	0.086	0.095
A1	-	0.2	-	0.008
b	0.68	0.9	0.026	0.036
b3	4.95	5.46	0.194	0.215
c	0.43	0.89	0.017	0.035
D	5.97	6.22	0.235	0.245
D1	5.300REF		0.209REF	
E	6.35	6.73	0.250	0.265
E1	4.32	--	0.170	-
e	2.286BSC		0.09BSC	
H	9.4	10.5	0.370	0.413
L	1.38	1.78	0.054	0.070
L1	2.90REF		0.114REF	
L2	0.51BSC		0.020BSC	
L3	0.88	1.28	0.034	0.050
L4	0.5	1	0.019	0.039
θ	0°	8°	0°	8°