

Features

- A real time watch
- A 20-hour adjustable range setting count-down timer
- 20-minute count-up display cycle time
- 20 hours of count-up time maximum
- Auto recycle or manual reset the count-down timer by bonding option
- Hours and minutes are set independently
- Real time display in timer mode
- 5-minute/10-minute pre-alarm
- DC output and piezo output
- An internal voltage doubler
- Busy flag output high in timer counting
- 3 1/2 digit LCD display
- 32768Hz crystal oscillator
- Single 1.5V battery operation
- 48L-pin QFP package

General Description

The HT1330 is a CMOS fabricated LSI chip designed to drive a standard three and 1/2 digit bplexed LCD for a count-up/down timer in watch applications. The watch and timer are based on a 32768Hz quartz crystal oscillator. The maximum count-down time is 20 hours with an accuracy of 1 second. The maximum count-up period is 20 hours, but the LCD will normally display a maximum period of 19 minutes and 59 seconds. If the user presses switch "S2", the total count-up time in hours and minutes will be displayed. In the count-up/down mode, the real time can be seen by pressing

switch "S1" and return to the count-up/down mode by releasing "S1".

Once the count-down is finished, the timer can either automatically recycle the preset time or manually reset the desired time depending on the selected bonding-pad option. The forecast alarm generates 4 alarm sounds at 10 minutes before set time and 8 alarm sounds at 5 minutes before set time. The HT1330 can be used as a parking timer, an alarm timer, a pill box timer, a kitchen timer, a sports timer, etc.

Pin Assignment

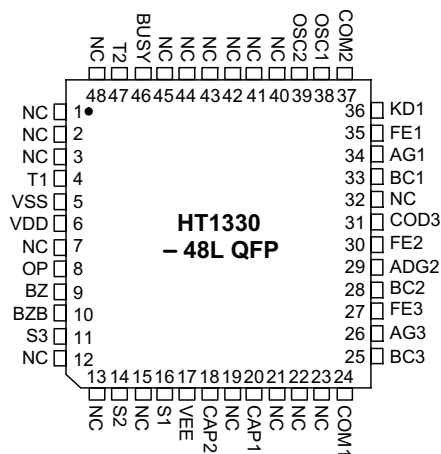

Pad Assignment
Pad Coordinates

Unit: mil

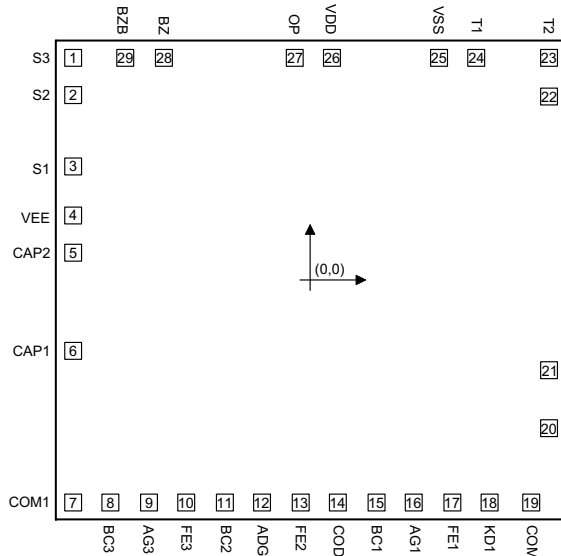

Pad No.	X	Y	Pad No.	X	Y
1	-62.7	58.7	16	27.3	-58.7
2	-62.7	48.7	17	37.3	-58.7
3	-62.7	30.1	18	47.3	-58.7
4	-62.7	17.2	19	58.3	-58.7
5	-62.7	7.3	20	62.7	-38.8
6	-62.7	-18.7	21	62.7	-23.7
7	-62.7	-58.7	22	62.7	48.6
8	-52.7	-58.7	23	62.7	58.7
9	-42.7	-58.7	24	43.8	58.7
10	-32.7	-58.7	25	33.8	58.7
11	-22.7	-58.7	26	5.8	58.7
12	-12.7	-58.7	27	-4.3	58.7
13	-2.7	-58.7	28	-38.6	58.7
14	7.3	-58.7	29	-48.6	58.7
15	17.3	-58.7			

 Chip size: $119 \times 112 \text{ (mil)}^2$

* The IC substrate should be connected to VDD in the PCB layout artwork.

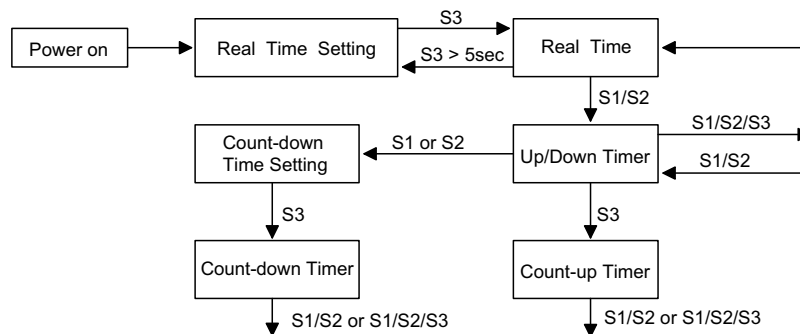
Operational Sequence

- Note: S1 for Hour setting
 S2 for Minute setting
 S3 to Start/Stop the timer
 S3>5 seconds into the real time setting mode
 S1/S2 to reset the timer to the initial state (0:00)
 S1/S2/S3 to return to the real time mode

Pin/Pad Description

Pin No.	Pad No.	Pad Name	I/O	Description
11	1	S3	I	Input to start/stop the timer
14	2	S2	I	Input for minute setting
16	3	S1	I	Input for hour setting
17	4	VEE	—	Negative voltage supply for LCD display
18	5	CAP2	O	For voltage doubling capacitor
20	6	CAP1	O	For voltage doubling capacitor
24	7	COM1	O	Common 1 drive
25	8	BC3	O	Segment drive
26	9	AG3	O	Segment drive
27	10	FE3	O	Segment drive
28	11	BC2	O	Segment drive
29	12	ADG2	O	Segment drive
30	13	FE2	O	Segment drive
31	14	COD3	O	Segment drive
33	15	BC1	O	Segment drive
34	16	AG1	O	Segment drive
35	17	FE1	O	Segment drive
36	18	KD1	O	Segment drive
37	19	COM2	O	Common 2 drive
38	20	OSC1	I	Oscillator input
39	21	OSC2	O	Oscillator output
46	22	BUSY	O	Timer busy flag, active high
47	23	T2	I/O	Chip test pin
4	24	T1	I/O	Fast-test control pin
5	25	VSS	—	Negative power supply
6	26	VDD	—	Positive power supply
8	27	OP	I	Option pin for countdown recycle
9	28	BZ	O	Piezo drive
10	29	BZB	O	Piezo drive

Absolute Maximum Rating

Supply Voltage.....	-0.3V to 5V	Storage Temperature.....	-50°C to 125°C
Input Voltage.....	V _{SS} -0.3V to V _{DD} +0.3V	Operating Temperature	-0°C to 70°C

Note: These are stress ratings only. Stresses exceeding the range specified under "Absolute Maximum Ratings" may cause substantial damage to the device. Functional operation of this device at other conditions beyond those listed in the specification is not implied and prolonged exposure to extreme conditions may affect device reliability.

Electric Characteristics

Ta=25°C

Symbol	Parameter	Test Conditions		Min.	Typ.	Max.	Unit
		V _{DD}	Conditions				
V _{DD}	Supply Voltage	1.5V	—	1.25	1.50	1.70	V
I _{DD}	Operating Current	1.5V	fosc=32768Hz No load	—	—	2	μA
V _{EE}	Display Voltage	1.25~1.7V	—	-1.2	-1.5	-1.7	V
I _{IN}	Switch Input Current	1.5V	V _{IN} =V _{DD}	5	—	65	μA
V _{STR}	Osc Starting Voltage	—	Within 3 secs	1.35	—	—	V
Δf/f	Frequency Stability	1.25~1.7V	—	—	—	10	PPM
I _{OHA}	Alarm Output Drive Current	1.5V	V _{OH} =1.35V	-480	—	—	μA
f _{OUT}	Alarm Output Frequency	1.5V	—	—	4096	—	Hz
I _{OHF}	Busy Flag Output Drive Current	1.5V	V _{OH} =1.35V	-480	—	—	μA

Functional Description

When power is turned on, all the LCD segments are illuminated to display "18:88" and the alarm sounds 2 seconds.

For fast-test, hold the "TP1" pin high and the minute digit will be increased every second.

In the count-down mode, when the time has gone past the set time and the alarm is stopped, the set time will remain at its current state or be reset to 0:00 depending on the bonding of the "OPT" pin to V_{DD}.

In the timer mode, while the timer is counting, the actual time can be displayed by pressing "S1". Once "S1" is released, the count-down time will

be shown instead.

In the count-up mode, the LCD display is normally in minutes and seconds where the maximum count-up period is 20 minutes. If "S2" is pressed, the LCD display will revert to hours and minutes and the maximum count-up time will turn out to be 20 hours.

The timer alarm will sound during the count-down process as listed below:

4 sounds are generated at 10 minutes before the set time is up.

8 sounds are generated at 5 minutes before the set time is up.

Once the set time is reached, the alarm will sound 60 seconds unless it is stopped by users (by pressing S3), in which case the preset time of the timer will remain unchanged or at 0:00 depending on the status of the option pin.

Pressing any one of the inputs (S1 or S2 or S3) will stop the alarm during the period for which the alarm is sounding.

At 0:00 in the timer mode, the alarm will sound when S1 and S2 are simultaneously depressed. This is for the alarm test only.

After the device is powered on, the alarm will sound two seconds and all segments on the LCD display panel be illuminated.

Output Waveform

10 minutes before set time is up

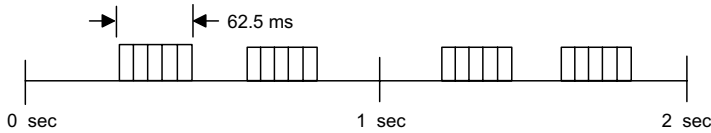

5 minutes before set time is up

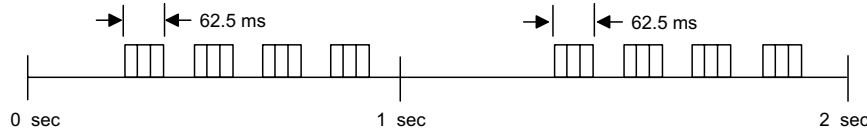

Time is up

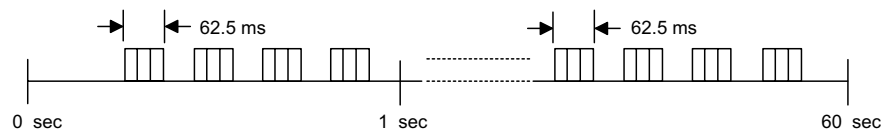

Timer busy flag output



Operational FlowChart

Note:

- S1/S2: two key pressed synch
- S1/S2/S3: three key pressed on time
- S3>5s: S3 key is pressed more than 5s
- S1, S2, S3: the key is pressed
- #: Represents 2Hz flash
- *: Represents 1Hz flash

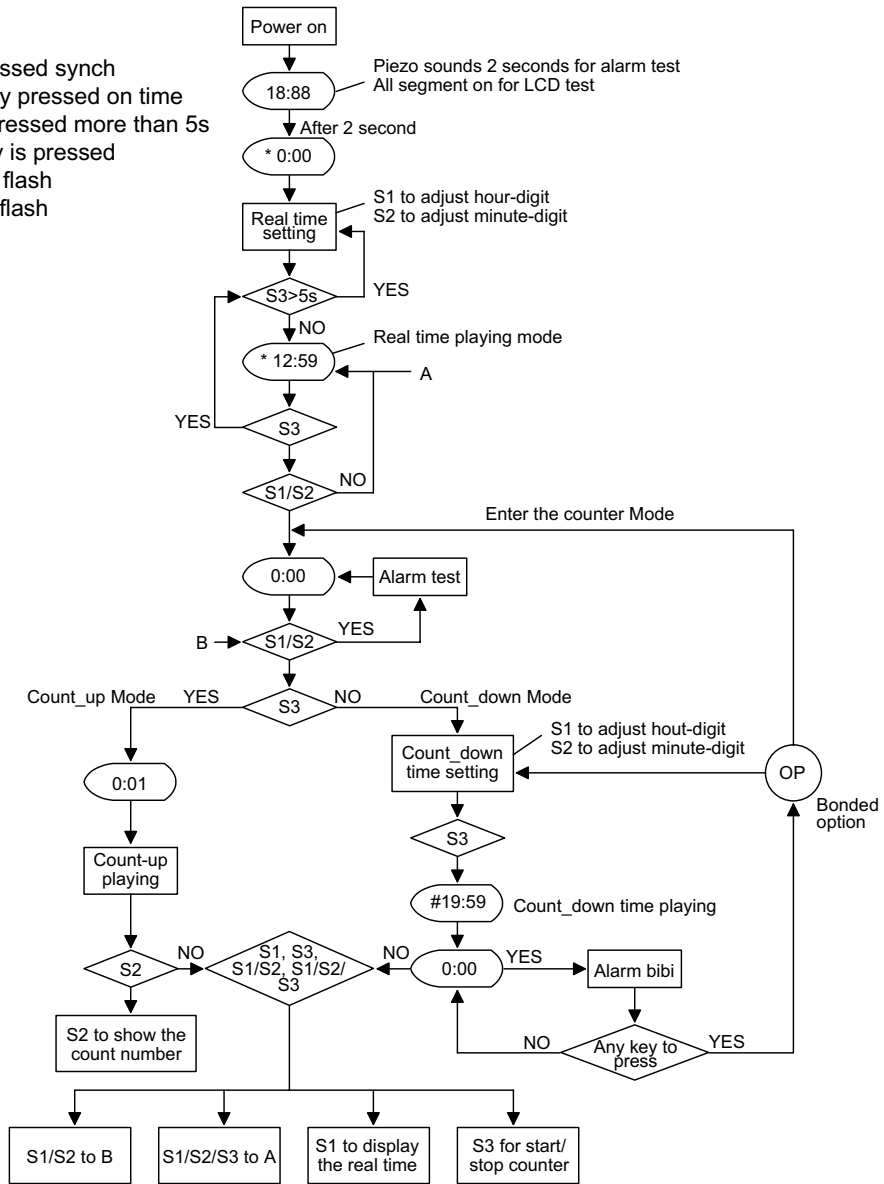

LCD Format

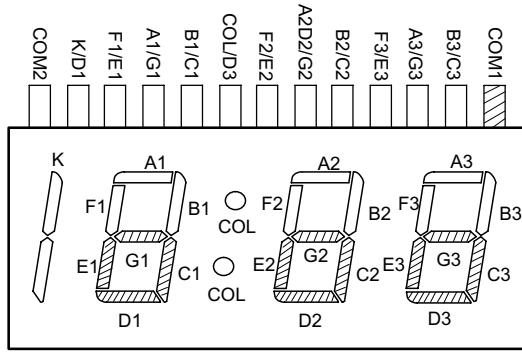

Application Circuits

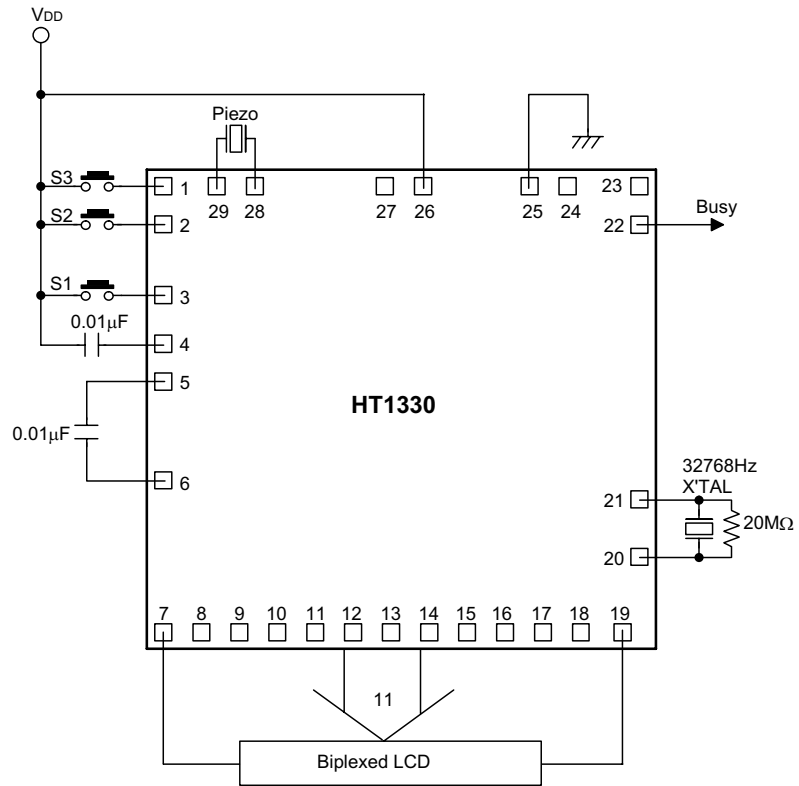

Holtek Semiconductor Inc. (Headquarters)

No.3 Creation Rd. II, Science-based Industrial Park, Hsinchu, Taiwan, R.O.C.
Tel: 886-3-563-1999
Fax: 886-3-563-1189

Holtek Semiconductor Inc. (Taipei Office)

5F, No.576, Sec.7 Chung Hsiao E. Rd., Taipei, Taiwan, R.O.C.
Tel: 886-2-2782-9635
Fax: 886-2-2782-9636
Fax: 886-2-2782-7128 (International sales hotline)

Holtek Semiconductor (Hong Kong) Ltd.

RM.711, Tower 2, Cheung Sha Wan Plaza, 833 Cheung Sha Wan Rd., Kowloon, Hong Kong
Tel: 852-2-745-8288
Fax: 852-2-742-8657

Copyright © 2000 by HOLTEK SEMICONDUCTOR INC.

The information appearing in this Data Sheet is believed to be accurate at the time of publication. However, Holtek assumes no responsibility arising from the use of the specifications described. The applications mentioned herein are used solely for the purpose of illustration and Holtek makes no warranty or representation that such applications will be suitable without further modification, nor recommends the use of its products for application that may present a risk to human life due to malfunction or otherwise. Holtek reserves the right to alter its products without prior notification. For the most up-to-date information, please visit our web site at <http://www.holtek.com.tw>.