

6.4W Anti-Clipping Mono Audio Power Amplifier

FEATURE

- Anti-Clipping Function, ACF
- Both Class D and Class AB are available
- Excellent EMI Suppression Performance
- Filter-less Modulation, Eliminating Output Filter
- Output Power
 - 1.4W ($V_{DD}=3.6V$, $R_L=4\Omega$, THD+N=10%, Class D)
 - 2.8W ($V_{DD}=5.0V$, $R_L=4\Omega$, THD+N=10%, Class D)
 - 4.7W ($V_{DD}=6.5V$, $R_L=4\Omega$, THD+N=10%, Class D)
 - 6.4W ($V_{DD}=6.5V$, $R_L=2\Omega$, THD+N=10%, Class D)
- 2.5W ($V_{DD}=5.0V$, $R_L=4\Omega$, THD+N=10%, Class AB)
- 5.2W ($V_{DD}=6.0V$, $R_L=2\Omega$, THD+N=10%, Class AB)
- High SNR: 95dB ($V_{DD} = 6.5V$, $A_v = 24dB$, THD+N = 1%)
- Low quiescent current
 - Input AC Grounded, Without Load, Class D
 - 2.65mA ($V_{DD}=3.6V$)
 - 3.25mA ($V_{DD}=5.0V$)
 - 4.00mA ($V_{DD}=6.5V$)
- Low shutdown current: $< 1\mu A$ (Input AC Grounded, Without Load)
- Over Current Protection and Thermal Protection with Auto Recovery
- Low voltage malfunction prevention function included
- Pb-Free Packages, SOP8, SOP8-PP

APPLICATIONS

- | | |
|---------------------------|----------------|
| • Portable Speakers | • PDAs |
| • iPhone/iPod/MP3 docking | • GPS |
| • Tablet PC/Note Book | • PMP/MP4/MP5 |
| • Portable Gamers | • Smart phones |

TYPICAL APPLICATION

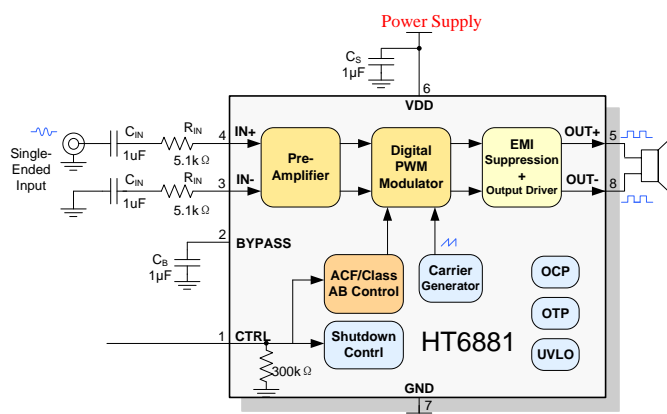

GENERAL DESCRIPTION

HT6881 is a Low-EMI, Anti-Clipping, filter-less mono Class D audio power amplifier IC with maximum output power of 6.4W (6.5V power supply, 2Ω load, 10% THD+N). It has a high efficiency with class AB amplifier performance.

HT6881 features Anti-Clipping Function (ACF) which detects and suppresses output signal clippings due to the over level inputs of music or voice signals. The ACF function also can adapt the output clippings caused by power supply voltage down in battery applications. It improves acoustical quality considerably, gives great listening enjoyment, and prevents speaker from overload damaging.

HT6881 has excellent EMI radiation suppression characteristics. The radiation level is well below FCC Part15 Class B standards without any additive design. It keeps from interference with other EMI sensitive circuits, simplifies system design and lowers system cost.

Class AB amplifier mode is also available for HT6881. Once the EMI Interference from class D becomes an annoying problem, HT6881 can be changed into Class AB mode.

HT6881 has a filter-less modulation circuit which directly drives speakers while realizes low distortion and low noise characteristics. Thanks to filter-less, circuit design with fewer external parts can be made in portable applications.

HT6881 has the independent Shutdown function which can minimize the power consumption at standby function. As for protection function, over current protection function for speaker output terminals, over temperature protection function, and low supply voltage malfunction preventing function are also prepared.

TERMINAL CONFIGURATION

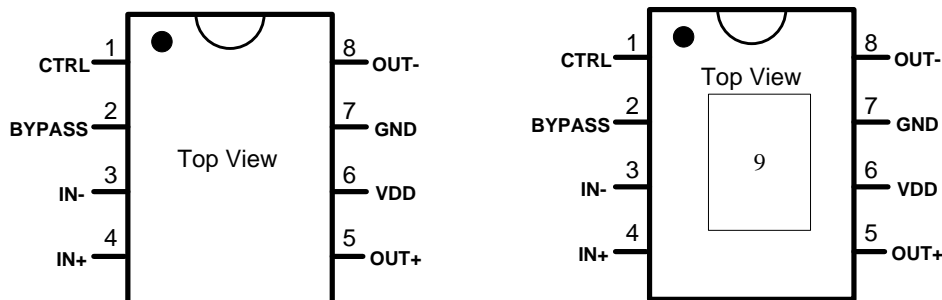

■ TERMINAL FUNCTION

Terminal No.	Name	I/O*1	ESD composition	Function
1	CTRL	I	PN	Mode control terminal
2	BYPASS	A	PN	Analog reference terminal
3	IN-	A	PN	Negative input terminal (differential -)
4	IN+	A	PN	Positive input terminal (differential +)
5	OUT+	O	-	Positive output terminal (differential +)
6	VDD	Power	-	Power supply
7	GND	GND	-	GND
8	OUT-	O	-	Negative output terminal (differential -)
9	-	-	-	PAD for heat radiation

*1 I: Input terminal O: Output terminal A: Analog terminal

when a voltage that is higher than the VDD potential is impressed into the terminal of PN (ESD protection circuit is composed of PMOS and NMOS), the leakage current flows through the protection circuit of PMOS.

■ ELECTRICAL CHARACTERISTIC

● Absolute Maximum Ratings *2

Item	Symbol	Min.	Max.	Unit
Power supply terminal voltage range (Class D)	V _{DD}	-0.3	7.0	V
Power supply terminal voltage range (Class AB)	V _{DD}	-0.3	6.5	V
Input terminal voltage range (IN+, IN-)	V _{IN}	V _{SS} -0.6	V _{DD} +0.6	V
Input terminal voltage range (except IN+, IN-)	V _{IN}	V _{SS} -0.3	V _{DD} +0.3	V
Operating Ambient Temperature	T _A	-40	85	°C
Junction Temperature	T _J	-40	150	°C
Storage Temperature	T _{STG}	-50	150	°C

*2 Absolute Maximum Ratings is values which must not be exceeded to guarantee device reliability. With a system in which input voltage might exceed supply voltage of VDD/GND, external diodes are recommended to be used to assure that the voltage does not exceed the absolute maximum rating.

● Recommended Operating Condition

Item	Symbol	Conditions	Min.	Typ.	Max.	Unit
Power Supply Voltage *3	V _{DD}	Class D	2.5	5	6.5	V
		Class AB	2.5	5	6.5	V
Operating Ambient Temperature	T _a	t _{SD} (Min.) = 50ms	-20	25	85	°C
		t _{SD} (Min.) = 80ms	-30			
Speaker Impedence	R _L	Class D	2	4		Ω
		Class AB	2	4		Ω

*3 The rising time of VDD should be longer than 1μs.

*4 It is recommended to operate at 3.6~5V power supply when HT6881 is driving a 2ohm speaker as load.

● DC Characteristics
 $V_{SS}=0V$, $V_{DD}=2.5V\sim 6.5V$, $T_a=-40^{\circ}C\sim 85^{\circ}C$, unless otherwise specified.

Item	Symbol	Conditions	Min.	Typ.	Max.	Unit
VDD power supply start-up threshold voltage	V_{UVLH}			2.10		V
VDD power supply shut-down threshold voltage	V_{UVLL}			1.90		V
ACF-OFF (Class D) mode threshold voltage for terminal CTRL	V_{MOD1}		2.3		V_{DD}	V
ACF-ON (Class D) mode threshold voltage for terminal CTRL	V_{MOD2}		1.6		2.2	V
ACF-OFF (Class AB) mode threshold voltage for terminal CTRL	V_{MOD3}		0.4	1	1.3	
SD mode threshold voltage for terminal CTRL	V_{MOD4}		V_{SS}		0.25	V
Quiescent current	I_{DD}	Class D, $V_{DD}=3.6V$, No load		2.65		mA
		Class D, $V_{DD}=5.0V$, No load		3.25		
		Class D, $V_{DD}=6.5V$, No load		4.00		
		Class AB, $V_{DD}=3.6V$, No load		6.40		
		Class AB, $V_{DD}=5.0V$, No load		7.90		
Consumption current in shutdown mode	I_{SD}	CTRL= V_{SS} , $T_a=25^{\circ}C$		0.01	1	μA
Voltage of terminal BYPASS	V_{BYPASS}			$V_{DD}/2$		V

*5 The voltage of CTRL terminal must be higher than 0.7V while HT6881 wakes up from shutdown mode or power off mode.

● Analog Characteristics *6
 $V_{SS}=0V$, $V_{DD}=5V$, $A_v=24.5dB$, $T_a=25^{\circ}C$, $C_{IN}=1\mu F$, $R_{IN}=5.1k\Omega$, ACF-Off (**Class D**) mode, unless otherwise specified.

Item	Symbol	Conditions	Min.	Typ.	Max.	Unit
Output Power	P_o	$R_L=4\Omega$, $V_{DD}=3.6V$	f=1kHz, THD+N=1%		1.10	W
		$R_L=4\Omega$, $V_{DD}=5.0V$			2.30	
		$R_L=4\Omega$, $V_{DD}=6.5V$			3.80	
		$R_L=2\Omega$, $V_{DD}=3.6V$			1.43	
		$R_L=2\Omega$, $V_{DD}=5.0V$			3.07	
		$R_L=2\Omega$, $V_{DD}=6.5V$			5.35	
		$R_L=4\Omega$, $V_{DD}=3.6V$	f=1kHz, THD+N=10%		1.40	
		$R_L=4\Omega$, $V_{DD}=5.0V$			2.80	
		$R_L=4\Omega$, $V_{DD}=6.5V$			4.70	
		$R_L=2\Omega$, $V_{DD}=3.6V$			1.72	
		$R_L=2\Omega$, $V_{DD}=5.0V$			3.75	
		$R_L=2\Omega$, $V_{DD}=6.5V$			6.40	
Total Harmonic Distortion plus Noise (BW: 20kHz)	THD+N	$R_L=4\Omega$, $P_o=1W$, f=1kHz		0.08		%
Output Noise	V_N	f=20Hz~20kHz, A加权, $A_v=24.5dB$		85		μV_{rms}
Signal /Noise Ratio	SNR	A-Filter, $A_v=24.5dB$, THD+N = 1%		91		dB
Power Supply Rejection ratio	PSRR	f=1kHz		-70		dB
Efficiency	η	$R_L=4\Omega+22\mu H$, THD+N = 1%		80		%
		$R_L=8\Omega+33\mu H$, THD+N = 1%		90		%
Output Offset Voltage	V_{OS}			± 6		mV
System Gain	A_{V0}	$R_{IN}=5.1k\Omega$		24.5		dB
ACF maximum attenuation gain	Aa	ACF-ON (Class D)	-10		0	dB

$V_{SS}=0V, V_{DD}=6.5V, A_v=24.5dB, T_a=25^{\circ}C, C_{IN}=1.0\mu F, R_{IN}=5.1k\Omega, ACF-Off$ (**Class D**) mode, unless otherwise specified.

Item	Symbol	Conditions	Min.	Typ.	Max.	Unit
Output Power	P_o	$R_L=4\Omega$	f=1kHz, THD+N=1%	3.80		W
		$R_L=2\Omega$		5.30		
		$R_L=4\Omega$	f=1kHz, THD+N=10%	4.70		
		$R_L=2\Omega$		6.40		
Total Harmonic Distortion plus Noise (BW: 20kHz)	THD+N	$R_L=4\Omega, P_o=1W, f=1kHz$		0.10		%
Output Noise	V_N	f=20Hz~20kHz, A加权, $A_v=24.5dB$		83		μV_{rms}
Signal /Noise Ratio	SNR	A加权, $A_v=24.5dB, THD+N = 1\%$		95		dB
Power Supply Rejection ratio	PSRR	f=1kHz		-70		dB
Efficiency	η	$R_L=4\Omega+22\mu H, THD+N = 1\%$		81		%
		$R_L=8\Omega+33\mu H, THD+N = 1\%$		91		%
Output Offset Voltage	V_{OS}			± 7.5		mV
System Gain	A_{v0}	$R_{IN}=5.1k\Omega$		24.5		dB
ACF maximum attenuation gain	Aa	ACF-ON (Class D)	-10		0	dB

 $V_{SS}=0V, V_{DD}=6.5V, A_v=24dB, T_a=25^{\circ}C, C_{IN}=1.0\mu F, R_{IN}=5.1k\Omega, ACF-Off$ (**Class AB**) mode, unless otherwise specified.

Item	Symbol	Conditions	Min.	Typ.	Max.	Unit
Output Power	P_o	$R_L=4\Omega$	f=1kHz, THD+N=1%	3.70		W
		$R_L=2\Omega(6V)$		3.92		
		$R_L=4\Omega$	f=1kHz, THD+N=10%	4.50		
		$R_L=2\Omega(6V)$		5.20		
Total Harmonic Distortion plus Noise (BW: 20kHz)	THD+N	$R_L=4\Omega, P_o=1W, f=1kHz$		0.06		%
Output Noise	V_N	f=20Hz~20kHz, A加权, $A_v=24.5dB$		110		μV_{rms}
Signal /Noise Ratio	SNR	A加权, $A_v=24.5dB, THD+N = 1\%$		90		dB
Efficiency	η	$R_L=4\Omega+22\mu H, THD+N = 1\%$		66		%
		$R_L=8\Omega+33\mu H, THD+N = 1\%$		69		%
Output Offset Voltage	V_{OS}			± 6		mV
System Gain	A_{v0}	$R_{IN}=5.1k\Omega$		24		dB

*6 All the values of analog characteristics were obtained by using our evaluation circumstance; Depending upon parts and pattern layout to use, characteristics may be changed.

For AB ,6V 2 Ω load is SOP8-PP package.

● AC Characteristics

 $V_{SS}=0V, V_{DD}=2.5$ to $6.5V, T_a=-30^{\circ}C\sim 85^{\circ}C$, unless otherwise specified.

Item	Symbol	Conditions	Min.	Typ.	Max.	Unit
Start-up time (or wake up from shutdown mode, or switch between Class AB and D)	t_{STUP}			100		ms
ACF Attack time	t_{AT1}	$V_{DD}=3.6V, g=10dB$		72		ms
ACF Release time	t_{RL1}	$V_{DD}=3.6V, g=10dB$		720		ms
Each mode setting time (Except shutdown nor switch between Class AB and D)	t_{MOD}		0.1			ms
Carrier clock frequency	f_{PWM}			488		KHz

TYPICAL OPERATING CHARACTERISTICS

Class D mode

V_{DD} vs I_{DD}

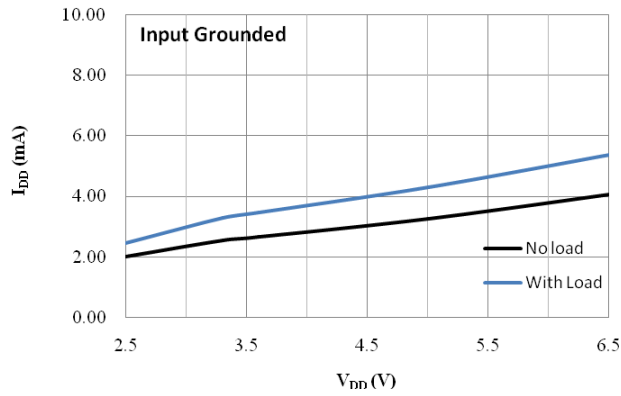

V_{DD} vs P_O

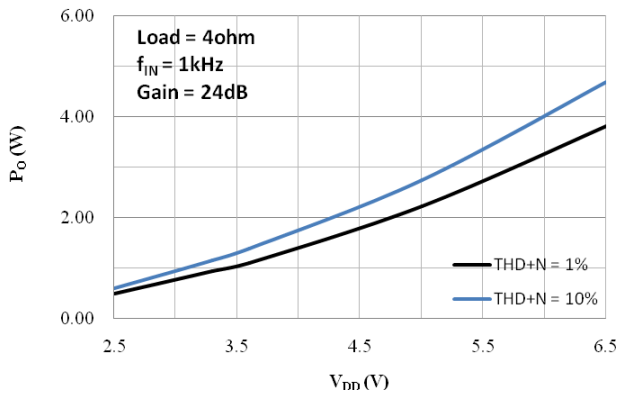

V_{DD} vs P_O

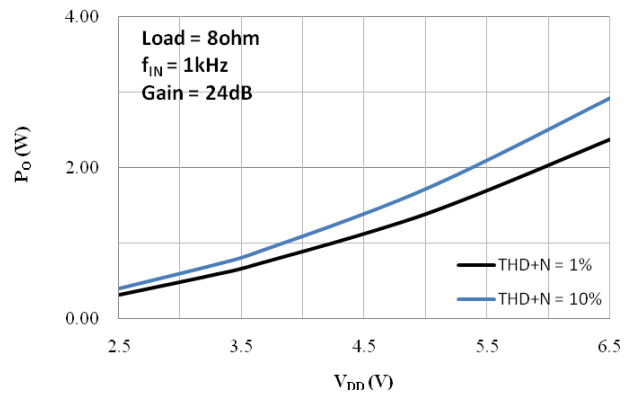

P_O vs THD+N

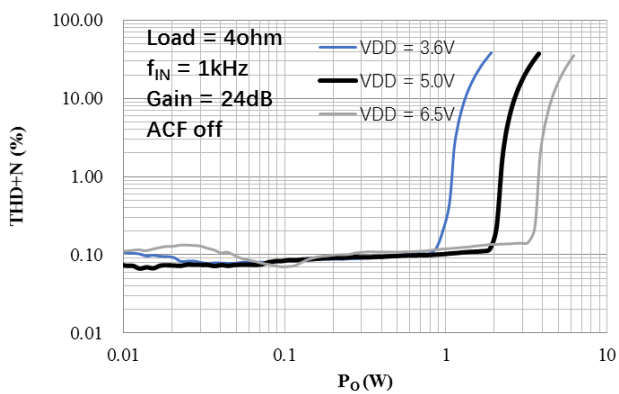

V_{IN} vs V_{OUT}

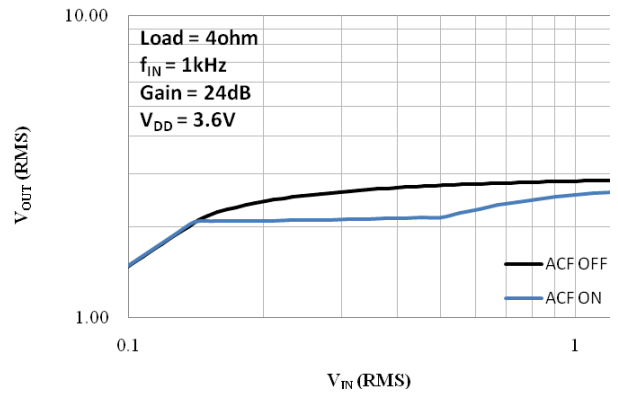

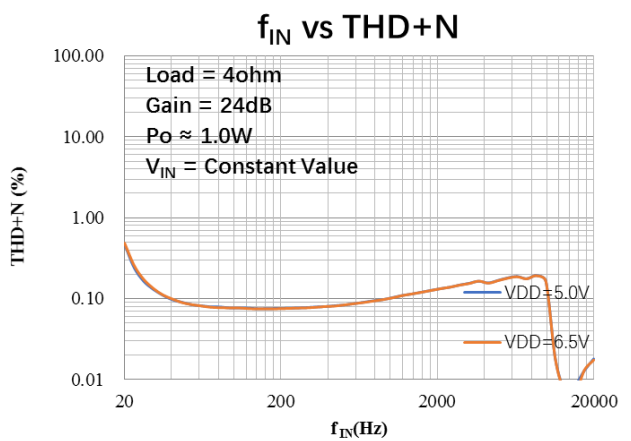
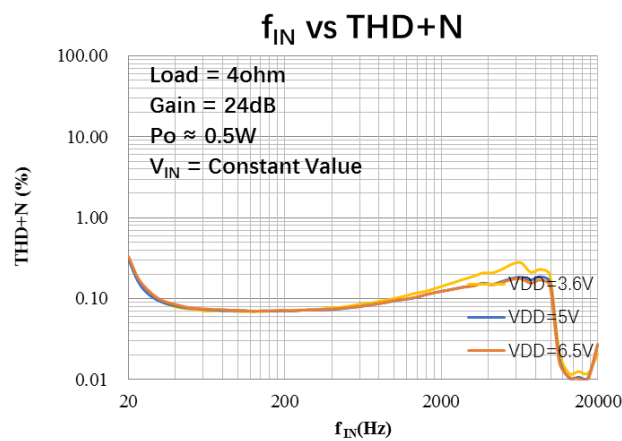
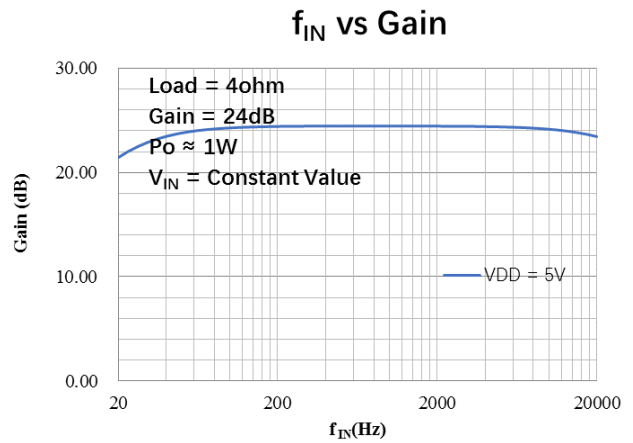
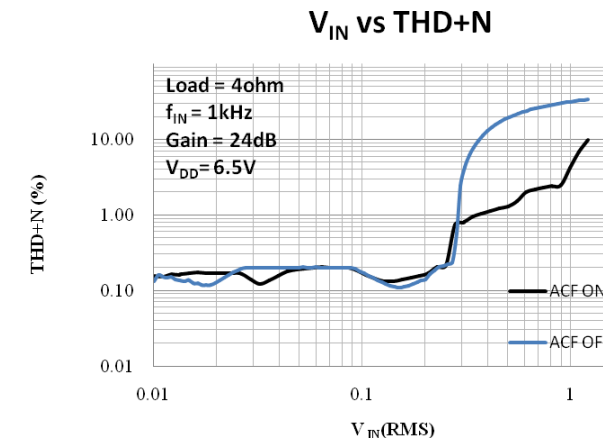
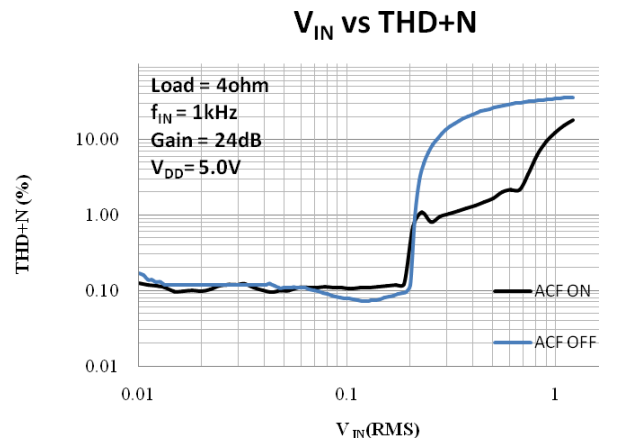
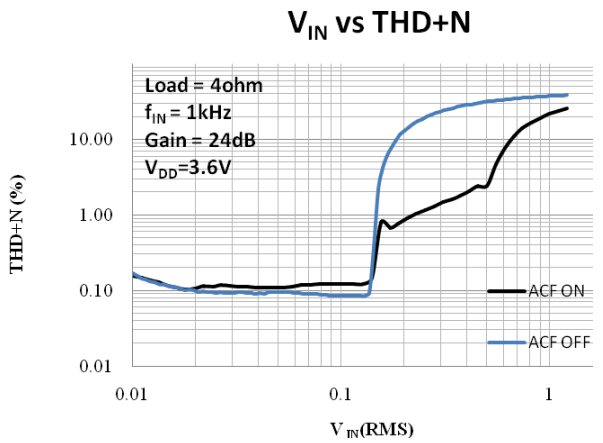
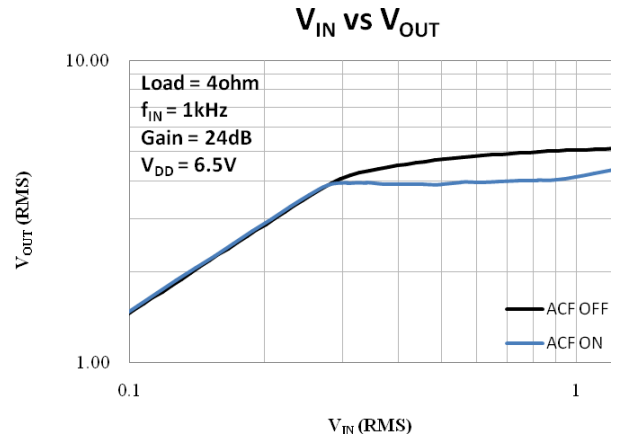
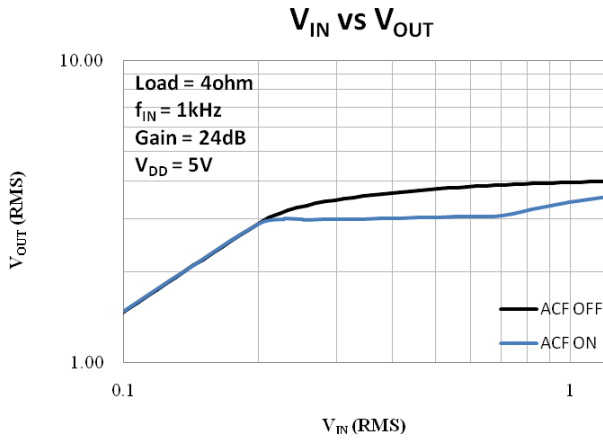

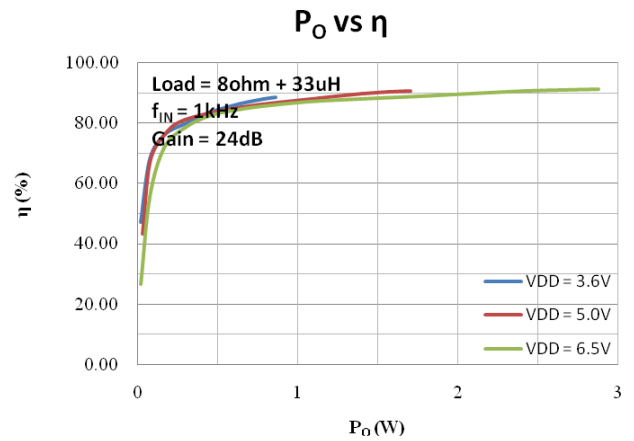
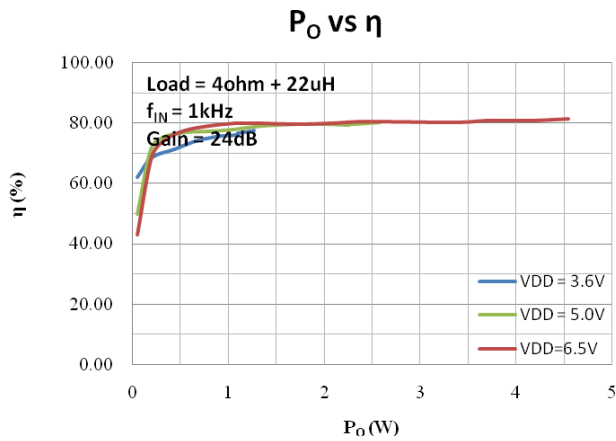
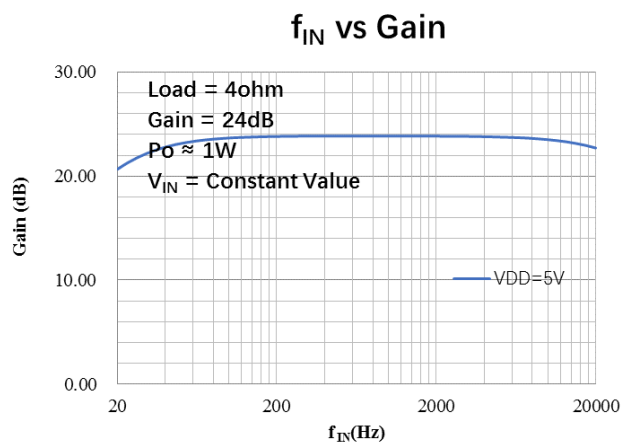
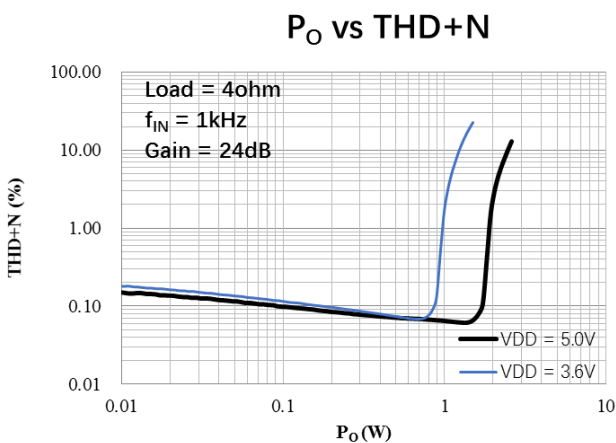
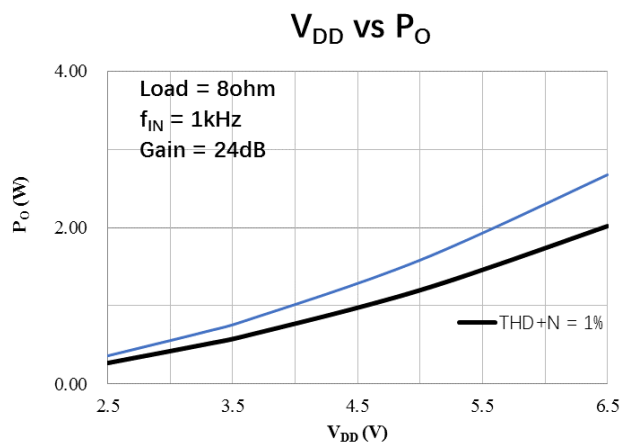
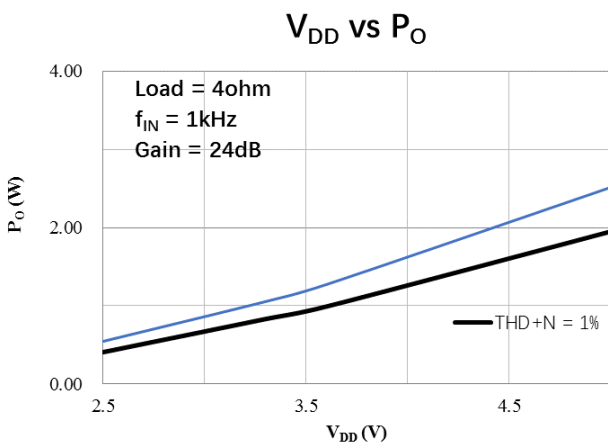
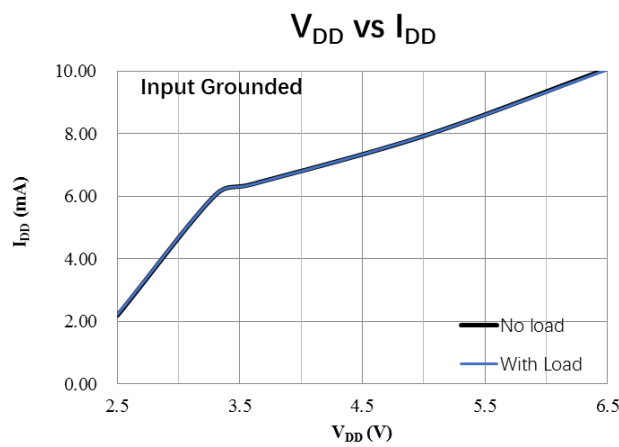
Class AB mode

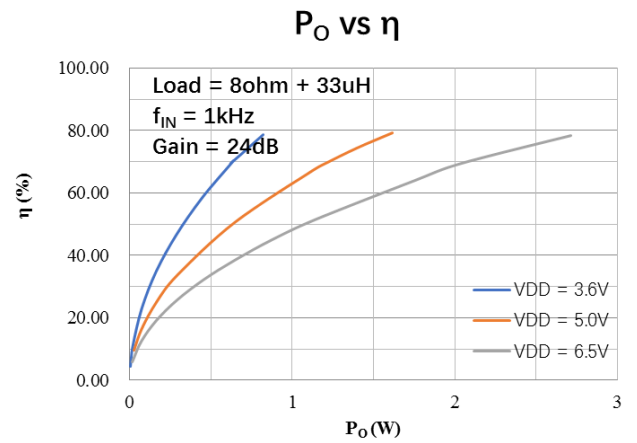
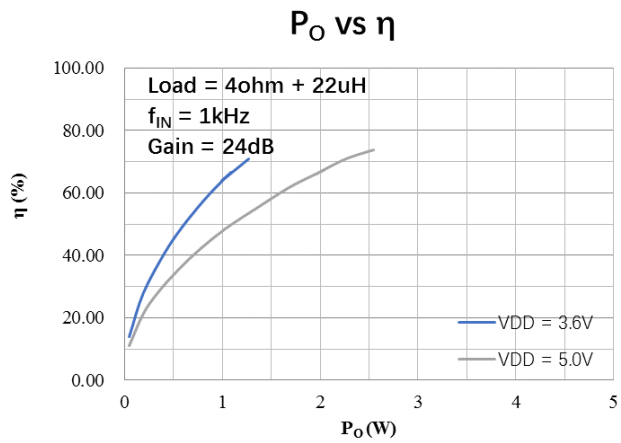
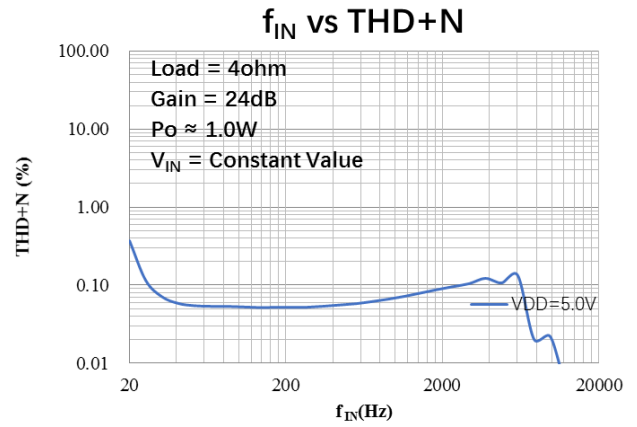
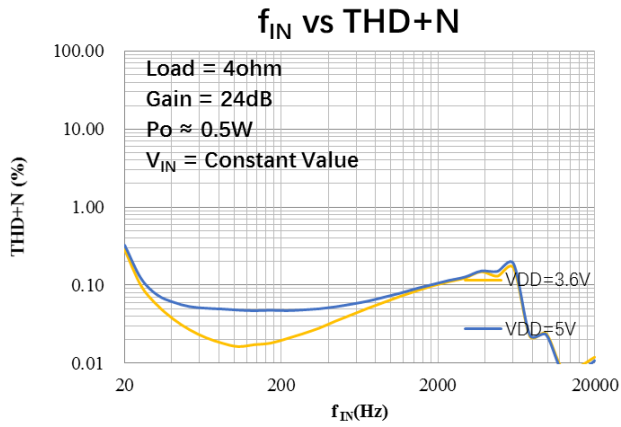

APPLICATION INFORMATION

Analog Signal Input Configuration

HT6881 is an amplifier with analog input (single-ended or differential), PWM pulse output (BTL only), and maximum output of 6.4W (RL=2Ω, VDD=6.5V) × 1ch when working in Class D mode. It can also operate in Class AB mode with analog input (single-ended or differential), analog output (BTL Only), and maximum output of 5.2W (RL=2Ω, VDD=6V) × 1ch.

For a differential input between IN+ and IN- pins, signals input via DC-cut capacitors (CIN). The input signal gain is calculated by $A_v = 200k / (7.2k + R_{IN})$, Gain = 20logAv. The real gain of Class AB will be one dB lower than the calculation result. And, the low pass cut-off frequency of input signal, can be calculated by $f_c = 1 / [2\pi (7.2k + R_{IN}) C_{IN}]$.

For a single-ended input at IN+ pin, signal input via a DC-cut capacitor (CIN). IN- pin should be connected to ground via a DC-cut capacitor (with the same value of CIN). The Gain and low pass Cut-off frequency are the same as the above case.

The output impedance (Zout) of the former source circuit, including signal paths up to IN+ terminal and IN-terminal should be designed to be 600Ω or lower.

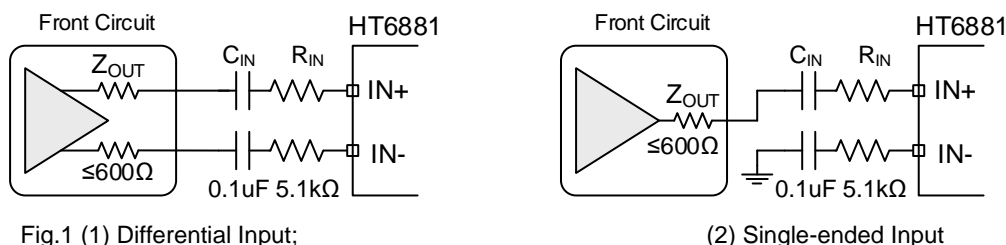

Fig.1 (1) Differential Input;

(2) Single-ended Input

CTRL Terminal Mode Control

Four operating mode, ACF-OFF (Class D), ACF-ON (Class D), ACF-OFF (Class AB) and SD (shutdown), could be implemented while different Setting Voltages input via CTRL terminal (see Table 1).

Table 1 Different Mode Setting Voltages of CTRL Terminal

Item	Symbol	Min.	Typ.	Max.	Unit
ACF-OFF (Class D) mode threshold voltage for terminal CTRL	V _{MOD1}	2.3	3.3	V _{DD}	V
ACF-ON (Class D) mode threshold voltage for terminal CTRL	V _{MOD2}	1.6	1.9	2.2	V
ACF-OFF (Class AB) mode threshold voltage for terminal CTRL	V _{MOD2}	0.4	1	1.4	
SD mode threshold voltage for terminal CTRL	V _{MOD4}	V _{SS}	0	0.25	V

Note that the voltage of CTRL terminal must be higher than 0.7V while HT6881 wakes up from shutdown mode or power off mode. And there is a 300kohm resistor pull down to the ground in the chip.

MCU Control Setting

By connecting external resistors (R_{CTRL1}, R_{CTRL2}, R_{CTRL3} accuracy of 1%) to CTRL terminal, and setting threshold voltage of each mode to CTRL1 and CTRL2 terminal, different modes can be set. Connect the terminal to the ground through a capacitor C_{CTRL} (a ceramic capacitor of 0.1μF or more) to eliminate noise during mode setting.

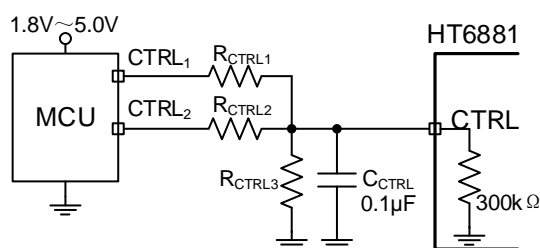

Fig 2 CTRL terminal control circuit

Table 2 Mode Setting

CTRL1	CTRL2	Mode
H	H	ACF-OFF (Class D)
H	L	ACF-ON (Class D)
L	H	ACF-Off (Class AB)
L	L	Shutdown

“H” indicates High level output voltage of microcomputer’s I/O port that is input to CTRL1 and CTRL2 terminals

and “L” indicates Ground level of the microcomputer. GND level of the microcomputer must be the same as that of HT6881. The control of CTRL terminal is based on I/O port H level output voltage of microcomputer that is connected.

● **CTRL Mode Function Detail**

(1) ACF-ON (Class D) Mode

In ACF-ON (Class D) mode, HT6881 which operates in Class D, attenuates system gain to an appropriate value when an excessive input is applied, so as not to cause the clipping at the differential signal output. In this way, the output audio signal is controlled in order to obtain a maximum output level without distortion. And HT6881 also follows to the clips of the output waveform due to the decrease in the power-supply voltage.

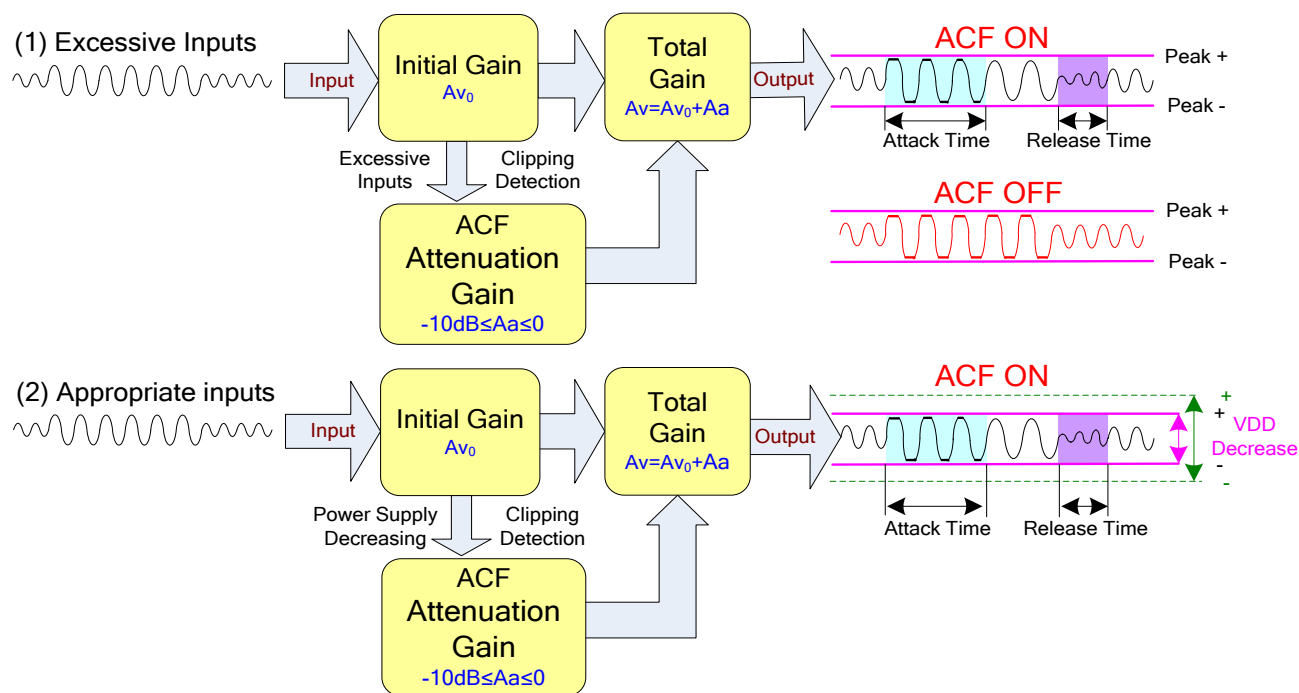

Fig 3 the ACF Function Operation Outline

The Attack time of ACF Function is a time interval until system gain falls to target attenuation gain -3dB when a big enough signal inputs. And, the Release Time is a time from target attenuation gain to not working of ACF. The maximum attenuation gain is 10dB.

Table 4 Attack time and Release time

ACF mode	Attack time	Release time
ACF	72ms	720ms

(2) ACF OFF Mode

In ACF-Off mode, ACF function is disabled. HT6881 will not detect output clipping and the system gain is kept being $Av=Av_0$. The audio quality would worsen due to clipping distortion. And Class D or Class AB operating mode can be chosen.

(3) SD Mode

In shutdown mode, HT6881 shuts all circuit down and minimizes the power consumption. And, the output terminals become Weak Low (A high resistance grounded state).

● **Pop-Click Noise Reduction**

The Pop-Click Noise Reduction Function of HT6881 works in the cases of Power-on, Power-off, Shutdown on, and Shutdown off. To achieve a more excellent noise reduction performance, it is recommended to use a DC-cut capacitor (C_{IN}) of 0.1 μ F or less.

Besides, POP noise can be minimal according to the following procedure of shutdown control.

- During power-on, Shutdown mode is not cancelled until the power supply is stabilized enough.
- Before Power-off, set Shutdown mode fist.

● Protection Function

HT6881 has the protection functions such as Over-Current Protection function, Thermal Protection function, and Low Voltage Malfunction Prevention function.

(1) Over-current Protection function

When a short circuit occurs between one output terminal and Ground, VDD, or the other output, the over-current protection mode starts up. In the over current protection mode, the differential output terminal becomes a high impedance state. Once the short circuit conditions are eliminated, the over current protection mode can be cancelled automatically.

(2) Thermal Protection function

When excessive high temperature of HT6881 (150°C) is detected, the thermal protection mode starts up. In the thermal protection mode, the differential output terminal becomes Weak Low state (a state grounded through high impedance).

(3) Low voltage Malfunction Prevention function

This is the function to establish the low voltage protection mode when VDD terminal voltage becomes lower than the detection voltage (V_{UVLL}) for the low voltage malfunction prevention. And the protection mode is canceled when VDD terminal voltage becomes higher than the threshold voltage (V_{UVLH}). In the low voltage protection mode, the differential output pin becomes Weak Low state (a state grounded through high impedance). HT6881 will start up within the start-up time (T_{STUP}) when the low voltage protection mode is cancelled

PACKAGE OUTLINE
SOP8

Unit mm

Symbol	Min.	Max.
A	1.35	1.75
A1	0.10	0.25
A2	1.35	1.55
b	0.33	0.51
c	0.17	0.25
D	4.70	5.10
E	3.80	4.00
E1	5.80	6.20
e	1.27(BSC)	
L	0.40	1.27
θ	0°	8°

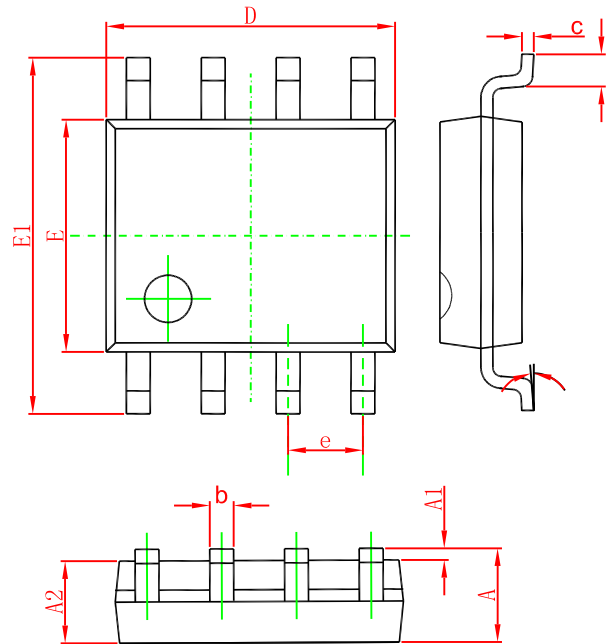

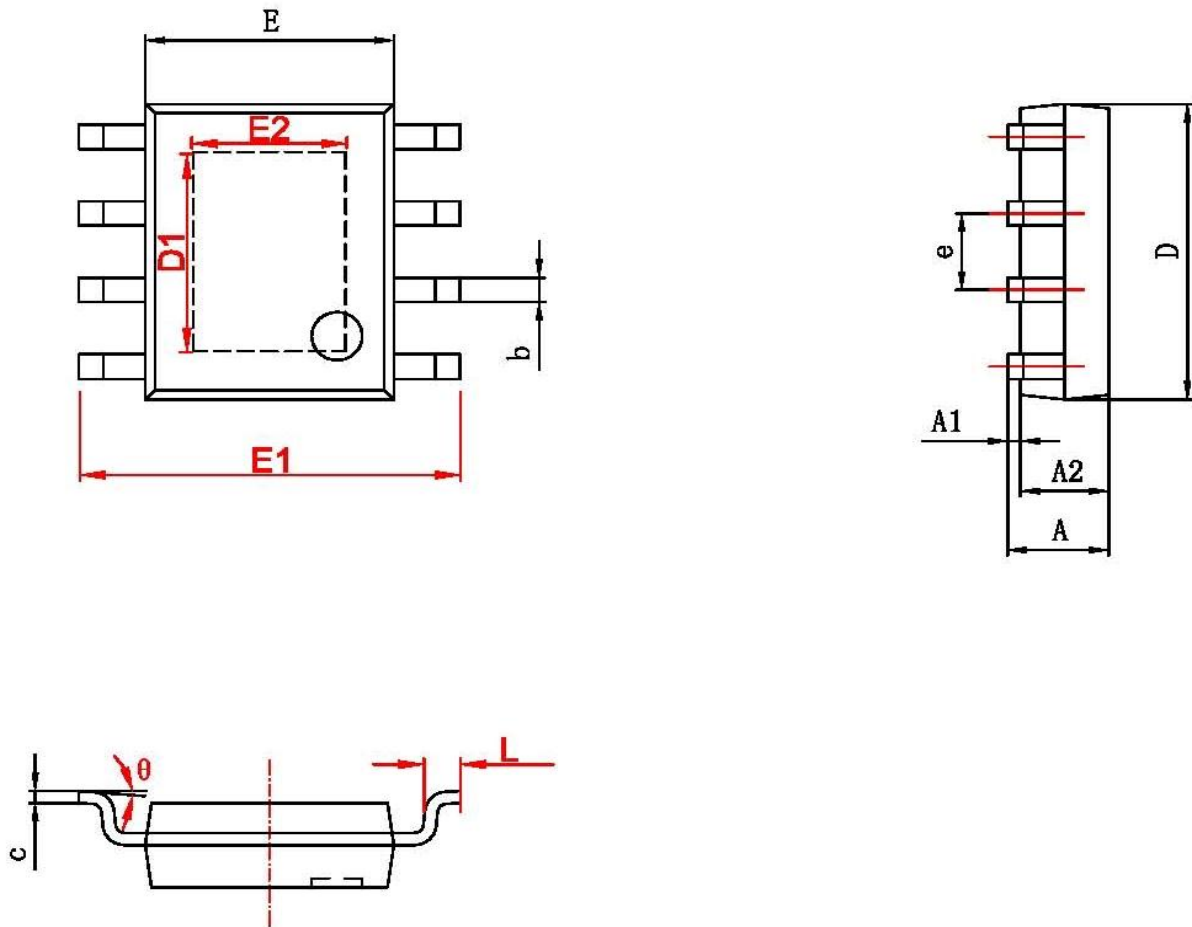
SOP8-PP(EXP PAD) PACKAGE OUTLINE DIMENSIONS

字符	Dimensions In Millimeters		Dimensions In Inches	
	Min	Max	Min	Max
A	1.350	1.750	0.053	0.069
A1	0.050	0.150	0.002	0.006
A2	1.350	1.550	0.053	0.061
b	0.330	0.510	0.013	0.020
c	0.170	0.250	0.007	0.010
D	4.700	5.100	0.185	0.200
D1	3.202	3.402	0.126	0.134
E	3.800	4.000	0.150	0.157
E1	5.800	6.200	0.228	0.244
E2	2.313	2.513	0.091	0.099
e	1.270 (BSC)		0.050 (BSC)	
L	0.400	1.270	0.016	0.050
θ	0°	8°	0°	8°

IMPORTANT NOTICE**注意**

Jiaxing Heroic Electronic Technology Co., Ltd (HT) reserves the right to make corrections, modifications, enhancements, improvements, and other changes to its products and services at any time and to discontinue any products or services. Customers should obtain the latest relevant information before placing orders and should verify that such information is current and complete.

嘉兴禾润电子科技有限公司（以下简称HT）保留对产品、服务、文档的任何修改、更正、提高、改善和其他改变，或停止提供任何产品和服务的权利。客户在下单和生产前应确保所得到的信息是最新、最完整的。

HT assumes no liability for applications assistance or customer product design. Customers are responsible for their products and applications using HT components.

HT对相关应用的说明和协助以及客户产品的板级设计不承担任何责任。

HT products are not authorized for use in safety-critical applications (such as life support devices or systems) where a failure of the HT product would reasonably be expected to affect the safety or effectiveness of that devices or systems.

HT的产品并未授权用于诸如生命维持设备等安全性极高的应用中。

The information included herein is believed to be accurate and reliable. However, HT assumes no responsibility for its use; nor for any infringement of patents or other rights of third parties which may result from its use.

本文中的相关信息是精确和可靠的，但HT并不对其负责，也不对任何可能的专利和第三方权利的伤害负责。

Following are URLs and contacts where you can obtain information or supports on any HT products and application solutions:

下面是可以联系到我公司的相关链接和联系方式：

嘉兴禾润电子科技有限公司
Jiaxing Heroic Electronic Technology Co., Ltd.

地址：浙江省嘉兴市凌公塘路3339号JRC大厦A座三层

Add: A 3rd floor, JRC Building, No. 3339, LingGongTang Road, Jiaxing, Zhejiang Province

Sales: 0573-82583866, sales@heroic.com.cn

Support: 0573-82586151, support@heroic.com.cn

Fax: 0573-82585078

E-mail: support@heroic.com.cn

Website: www.heroic.com.cn; wap.heroic.com.cn

Wechat MP: HEROIC_JX

QQ: 75467400

请及时关注禾润官方微信公众号，随时获取最新产品信息和技术资料！

