

**Features**

- Low power consumption
- Low temperature coefficient
- Built-in high-stability reference source
- Built-in hysteresis characteristic
- TO-92 & SOT-89 package

**Applications**

- Battery checkers
- Level selectors
- Power failure detectors
- Microcomputer reset
- Battery memory backup
- Non-volatile RAM signal storage protectors

**General Description**

The HT70XX series is a set of three-terminal low power voltage detectors implemented in CMOS technology. Each voltage detector in the series detects a particular fixed voltage ranging from 2.4V to 7V. The voltage detectors consist of a high-precision and low power consumption standard voltage source, a comparator, hysteresis circuit, and an output driver. CMOS technology ensures low power consumption.

Although designed primarily as fixed voltage detectors, these devices can be used with external components to detect user specified threshold voltages (NMOS open drain type only).

**Selection Table**

Part No.	Detectable Voltage	Hysteresis Width	Tolerance
HT7024A	2.4V	0.12V	±5%
HT7027A	2.7V	0.135V	±5%
HT7033A	3.3V	0.165V	±5%
HT7039A	3.9V	0.195V	±5%
HT7044A	4.4V	0.22V	±5%
HT7050A	5V	0.25V	±5%
HT7070A	7V	0.35V	±5%

Note: The output type selection codes are:

NMOS open drain normal open, active low

PMOS open drain normal open, active high

For example: The HT7070A is a 7V, NMOS open drain active low output

Output type selection table

Type	$V_{DD}$	$V_{DD} > V_{DET}(+)$	$V_{DD} \leq V_{DET}(-)$
A		Hi-Z	VSS

Block Diagram

N channel open drain output (normal open; active low)

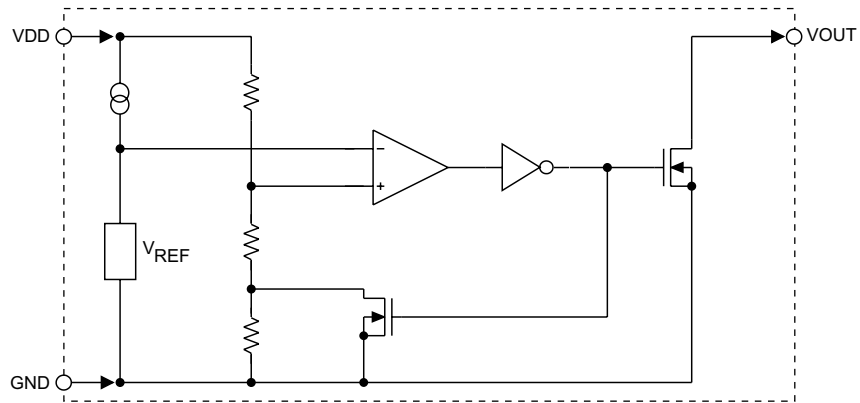

A type

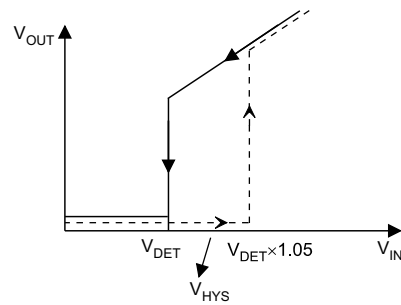

Dash line ...  $V_{IN}$  from  $L_O \rightarrow H_I$   
 Solid line ...  $V_{IN}$  from  $H_I \rightarrow L_O$

**Pin Assignment**

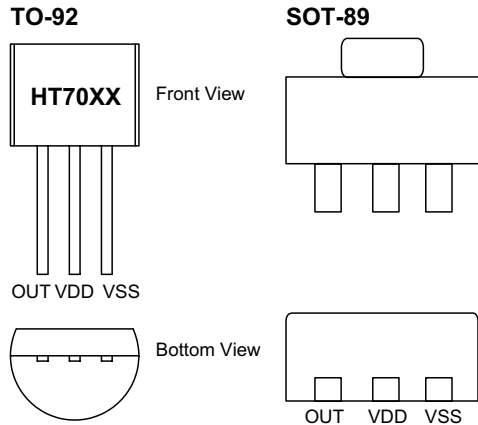

**Pad Assignment**

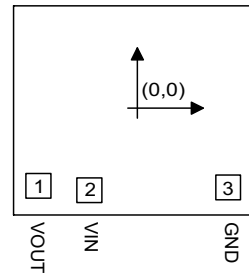

Chip size: 1317 × 1158 (μm)<sup>2</sup>

\* The IC substrate should be connected to VDD in the PCB layout artwork.

**Pad Coordinates**

Unit: μm

Pad No.	X	Y
1	-483.30	-379.50
2	-234.60	-399.50
3	443.90	-386.00

**Absolute Maximum Ratings**

Supply Voltage.....	-0.3V to 26V	Output Current.....	50mA
Output Voltage.....	V <sub>SS</sub> -0.3V to V <sub>DD</sub> +0.3V	Storage Temperature.....	-50°C to 125°C
Power Consumption.....	200mW	Operating Temperature.....	0°C to 70°C

Note: These are stress ratings only. Stresses exceeding the range specified under "Absolute Maximum Ratings" may cause substantial damage to the device. Functional operation of this device at other conditions beyond those listed in the specification is not implied and prolonged exposure to extreme conditions may affect device reliability.

**Electrical Characteristics**
**HT7024A**

Ta=25°C

Symbol	Parameter	Test Conditions		Min.	Typ.	Max.	Unit
		V <sub>DD</sub>	Conditions				
V <sub>DET</sub>	Hi→Lo Detectable Voltage	—	—	2.28	2.4	2.52	V
	Lo→Hi Detectable Voltage	—	—	2.325	2.52	2.772	V
V <sub>HYS</sub>	Hysteresis Width	—	—	0.02 V <sub>DET</sub>	0.05 V <sub>DET</sub>	0.1 V <sub>DET</sub>	V
I <sub>DD</sub>	Operating Current	8	No load	—	4	7	μA
V <sub>DD</sub>	Operating Voltage	—	—	1.5	—	24	V
I <sub>OL</sub>	Output Sink Current	2	V <sub>OUT</sub> =0.2V	0.5	1	—	mA
$\frac{\Delta V_{DET}}{\Delta T_A}$	Temperature Coefficient	—	0°C<Ta<70°C	—	±0.9	—	mV/°C

**HT7027A**

Ta=25°C

Symbol	Parameter	Test Conditions		Min.	Typ.	Max.	Unit
		V <sub>DD</sub>	Conditions				
V <sub>DET</sub>	Hi→Lo Detectable Voltage	—	—	2.565	2.7	2.835	V
	Lo→Hi Detectable Voltage	—	—	2.616	2.835	3.118	V
V <sub>HYS</sub>	Hysteresis Width	—	—	0.02 V <sub>DET</sub>	0.05 V <sub>DET</sub>	0.1 V <sub>DET</sub>	V
I <sub>DD</sub>	Operating Current	8	No load	—	4	7	μA
V <sub>DD</sub>	Operating Voltage	—	—	1.5	—	24	V
I <sub>OL</sub>	Output Sink Current	2	V <sub>OUT</sub> =0.2V	0.5	1	—	mA
$\frac{\Delta V_{DET}}{\Delta T_A}$	Temperature Coefficient	—	0°C<Ta<70°C	—	±0.9	—	mV/°C

**HT7033A**

Ta=25°C

Symbol	Parameter	Test Conditions		Min.	Typ.	Max.	Unit
		V <sub>DD</sub>	Conditions				
V <sub>DET</sub>	Hi→Lo Detectable Voltage	—	—	3.135	3.3	3.465	V
	Lo→Hi Detectable Voltage	—	—	3.197	3.465	3.811	V
V <sub>HYS</sub>	Hysteresis Width	—	—	0.02 V <sub>DET</sub>	0.05 V <sub>DET</sub>	0.1 V <sub>DET</sub>	V
I <sub>DD</sub>	Operating Current	8	No load	—	4	7	μA
V <sub>DD</sub>	Operating Voltage	—	—	1.5	—	24	V
I <sub>OL</sub>	Output Sink Current	2.5	V <sub>OUT</sub> =0.25V	1.2	2.5	—	mA
$\frac{\Delta V_{DET}}{\Delta T_A}$	Temperature Coefficient	—	0°C<Ta<70°C	—	±0.9	—	mV/°C

**HT7039A**

Ta=25°C

Symbol	Parameter	Test Conditions		Min.	Typ.	Max.	Unit
		V <sub>DD</sub>	Conditions				
V <sub>DET</sub>	Hi→Lo Detectable Voltage	—	—	3.705	3.9	4.095	V
	Lo→Hi Detectable Voltage	—	—	3.779	4.095	4.504	V
V <sub>HYS</sub>	Hysteresis Width	—	—	0.02 V <sub>DET</sub>	0.05 V <sub>DET</sub>	0.1 V <sub>DET</sub>	V
I <sub>DD</sub>	Operating Current	8	No load	—	4	7	μA
V <sub>DD</sub>	Operating Voltage	—	—	1.5	—	24	V
I <sub>OL</sub>	Output Sink Current	2.5	V <sub>OUT</sub> =0.25V	1.2	2.5	—	mA
$\frac{\Delta V_{DET}}{\Delta T_A}$	Temperature Coefficient	—	0°C<Ta<70°C	—	±0.9	—	mV/°C

**HT7044A**

Ta=25°C

Symbol	Parameter	Test Conditions		Min.	Typ.	Max.	Unit
		V <sub>DD</sub>	Conditions				
V <sub>DET</sub>	Hi→Lo Detectable Voltage	—	—	4.18	4.4	4.62	V
	Lo→Hi Detectable Voltage	—	—	4.263	4.62	5.082	V
V <sub>HYS</sub>	Hysteresis Width	—	—	0.02 V <sub>DET</sub>	0.05 V <sub>DET</sub>	0.1 V <sub>DET</sub>	V
I <sub>DD</sub>	Operating Current	8	No load	—	4	7	μA
V <sub>DD</sub>	Operating Voltage	—	—	1.5	—	24	V
I <sub>OL</sub>	Output Sink Current	3.6	V <sub>OUT</sub> =0.36V	3	6	—	mA
$\frac{\Delta V_{DET}}{\Delta T_A}$	Temperature Coefficient	—	0°C<Ta<70°C	—	±0.9	—	mV/°C

**HT7050A**

Ta=25°C

Symbol	Parameter	Test Conditions		Min.	Typ.	Max.	Unit
		V <sub>DD</sub>	Conditions				
V <sub>DET</sub>	Hi→Lo Detectable Voltage	—	—	4.75	5	5.25	V
	Lo→Hi Detectable Voltage	—	—	4.845	5.25	5.775	V
V <sub>HYS</sub>	Hysteresis Width	—	—	0.02 V <sub>DET</sub>	0.05 V <sub>DET</sub>	0.1 V <sub>DET</sub>	V
I <sub>DD</sub>	Operating Current	8	No load	—	4	7	μA
V <sub>DD</sub>	Operating Voltage	—	—	2.1	—	24	V
I <sub>OL</sub>	Output Sink Current	3.6	V <sub>OUT</sub> =0.36V	3	6	—	mA
$\frac{\Delta V_{DET}}{\Delta T_A}$	Temperature Coefficient	—	0°C<Ta<70°C	—	±0.9	—	mV/°C

HT7070A

Ta=25°C

Symbol	Parameter	Test Conditions		Min.	Typ.	Max.	Unit
		V <sub>DD</sub>	Conditions				
V <sub>DET</sub>	Hi→Lo Detectable Voltage	—	—	6.65	7	7.35	V
	Lo→Hi Detectable Voltage	—	—	6.783	7.35	8.085	V
V <sub>HYS</sub>	Hysteresis Width	—	—	0.02 V <sub>DET</sub>	0.05 V <sub>DET</sub>	0.1 V <sub>DET</sub>	V
I <sub>DD</sub>	Operating Current	8	No load	—	4	7	μA
V <sub>DD</sub>	Operating Voltage	—	—	2.1	—	24	V
I <sub>OL</sub>	Output Sink Current	5	V <sub>OUT</sub> =0.5V	5	10	—	mA
$\frac{\Delta V_{DET}}{\Delta T_A}$	Temperature Coefficient	—	0°C<Ta<70°C	—	±0.9	—	mV/°C

### Functional Description

The HT70XX series is a set of voltage detectors equipped with a high stability voltage reference which is connected to the negative input of a comparator—denoted as V<sub>REF</sub> in the following figure for NMOS output voltage detector.

When the voltage drop to the positive input of the comparator (i.e,V<sub>B</sub>) is higher than V<sub>REF</sub>, V<sub>OUT</sub> goes high, M1 turns off, and V<sub>B</sub> is expressed as V<sub>BH</sub>=VDD×(RB+RC)/(RA+RB+RC). If VDD is decreased so that V<sub>B</sub> falls to a value less than V<sub>REF</sub>, the comparator output inverts from high to low, V<sub>OUT</sub> goes low, V<sub>C</sub> is high, M1 turns on, RC is bypassed, and V<sub>B</sub> becomes: V<sub>BL</sub>=VDD×RB/(RA+RB), which is less than V<sub>BH</sub>. By so doing, the comparator output will stay low to prevent the circuit from oscillating when V<sub>B</sub> ≈ V<sub>REF</sub>.

If VDD falls below the minimum operating voltage, the output becomes undefined. When VDD goes from low to VDD×RB/(RA+RB) > V<sub>REF</sub>, the comparator output and V<sub>OUT</sub> goes high.

The detectable voltage is defined as:

$$V_{DET}(-) = \frac{RA + RB + RC}{RB + RC} \times V_{REF}$$

The release voltage is defined as:

$$V_{DET}(+) = \frac{RA + RB}{RB} \times V_{REF}$$

The hysteresis width is:

$$V_{HYS} = V_{DET}(+) - V_{DET}(-)$$

The figure demonstrates the NMOS output type with positive output polarity (V<sub>OUT</sub> is normally open, active low). The HT70XX series also supplies options for other output types with active high outputs. Application circuits shown are examples of positive output polarity (normally open, active low) unless otherwise specified.

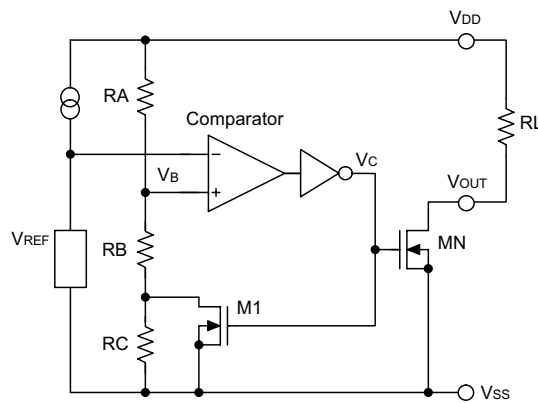

NMOS output voltage detector (HT70XXA)

## Application Circuits

### Microcomputer reset circuit

Normally a reset circuit is required to protect the microcomputer system from malfunctions due to power line interruptions. The following examples show how different output configurations perform a reset function in various systems.

- NMOS open drain output application for separate power supply

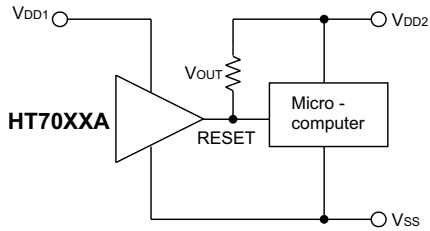

- NMOS open drain output application with R-C delay

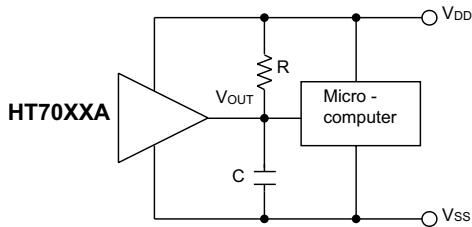

### Power-on reset circuit

With several external components, the NMOS open drain type of the HT70XX series can be used to perform a power-on reset function as shown:

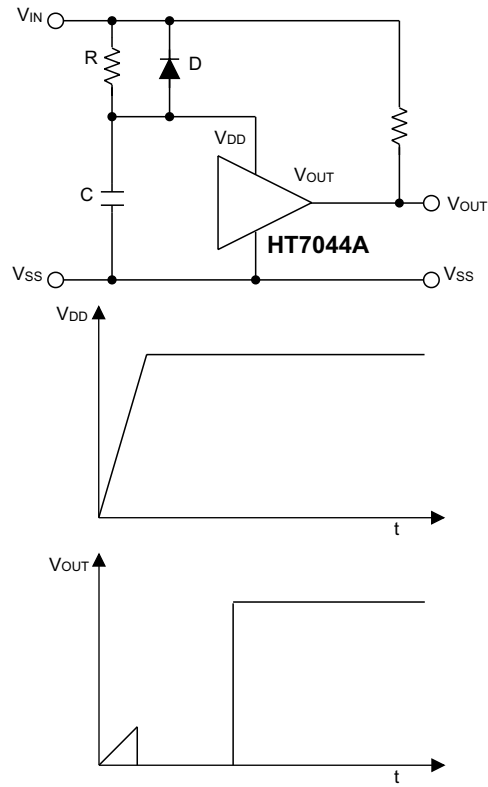



**5V power line monitoring circuit**

Generally, a minimum operating voltage of 4.5V is guaranteed in a 5V power line system. The HT7044A is recommended for use as 5V power line monitoring circuit.

- 5V power line monitor with power-on reset

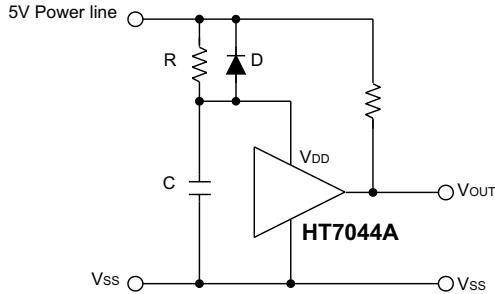

- with 5V voltage regulator

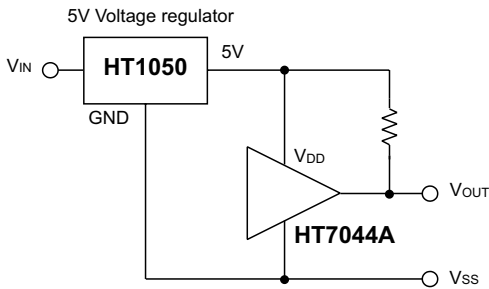

**Change of detectable voltage**

If the required voltage is not found in the standard product selection table, it is possible to change it by using external resistance dividers or diodes.

- Varying the detectable voltage with a resistance divider

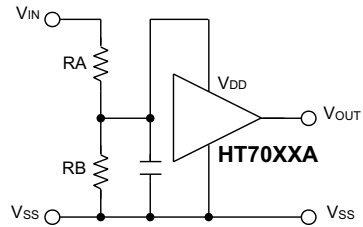

$$\text{Detectable voltage} = \frac{RA + RB}{RB} \times V_{DET}$$

$$\text{Hysteresis width} = \frac{RA + RB}{RB} \times V_{HYS}$$

- Varying the detectable voltage with a diode

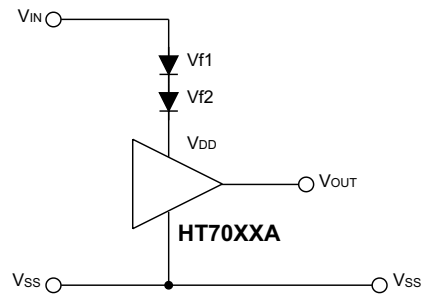

$$\text{Detectable Voltage} = V_{f1} + V_{f2} + V_{DET}$$

**Malfunction analysis**

The following circuit demonstrates the way a circuit analyzes malfunctions by monitoring the variation or spike noise of power supply voltage.

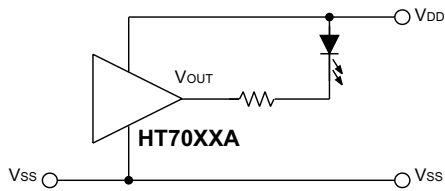

**Charge monitoring circuit**

The following circuit shows a charged monitor for protection against battery deterioration by overcharging. When the voltage of the battery is higher than the set detectable voltage, the transistor turns on to bypass the charge current, protecting the battery from overcharging.

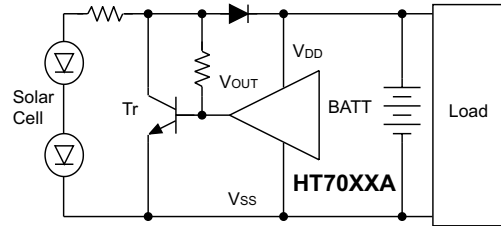

**Level selector**

The following diagram illustrates a logic level selector.

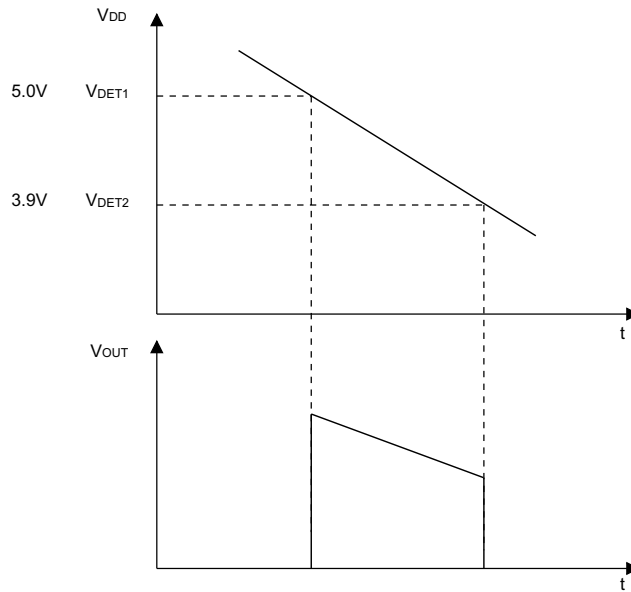
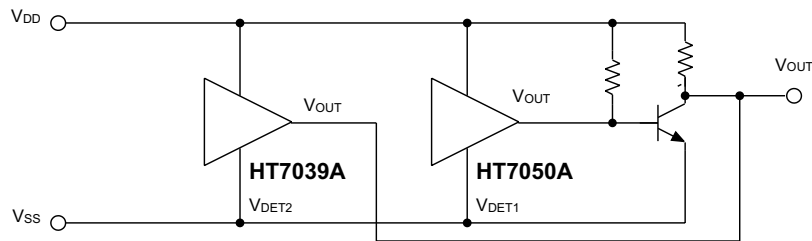

**Holtek Semiconductor Inc. (Headquarters)**

No.3 Creation Rd. II, Science-based Industrial Park, Hsinchu, Taiwan, R.O.C.  
Tel: 886-3-563-1999  
Fax: 886-3-563-1189

**Holtek Semiconductor Inc. (Taipei Office)**

5F, No.576, Sec.7 Chung Hsiao E. Rd., Taipei, Taiwan, R.O.C.  
Tel: 886-2-2782-9635  
Fax: 886-2-2782-9636  
Fax: 886-2-2782-7128 (International sales hotline)

**Holtek Semiconductor (Hong Kong) Ltd.**

RM.711, Tower 2, Cheung Sha Wan Plaza, 833 Cheung Sha Wan Rd., Kowloon, Hong Kong  
Tel: 852-2-745-8288  
Fax: 852-2-742-8657

Copyright © 2000 by HOLTEK SEMICONDUCTOR INC.

The information appearing in this Data Sheet is believed to be accurate at the time of publication. However, Holtek assumes no responsibility arising from the use of the specifications described. The applications mentioned herein are used solely for the purpose of illustration and Holtek makes no warranty or representation that such applications will be suitable without further modification, nor recommends the use of its products for application that may present a risk to human life due to malfunction or otherwise. Holtek reserves the right to alter its products without prior notification. For the most up-to-date information, please visit our web site at <http://www.holtek.com.tw>.