

Features

- Output Current: 300mA/Each Channel
- Dropout Voltage: 0.34V (Typ.)
($V_{OUT}=2.5V@I_{OUT}=300mA$)
- Maximum Input Voltage: 7.0V
- Output Voltage Range: 1.5~5.0V
- High Output Voltage Accuracy: $\pm 2\%$
- Low Power Consumption: 30 μ A (typ.)
- High Ripple Rejection: 70dB (1kHz@ $I_{OUT}=30mA$)
- Operating Temperature: -40°C~85°C
- Low ESR Capacitor Compatible: Ceramic Capacitor
- Over Temperature Protection
- Current Limiting
- Ultra Small Package: SOT23-6

Applications

- Mobile phones
- Cordless phones and radio communication equipment
- Portable games
- Camera, Video recorders
- Portable audio equipment

General Description

The HT72Dxxxx series are CMOS-based voltage regulator ICs with high output voltage accuracy, The devices possess the benefits of dual outputs, low output noise, high ripple rejection ratio, low dropout and very fast turn-on times.

The devices include a reference voltage sources, error amplifiers, driver transistors, current limiters and phase compensators, all fully integrated.

The HT72Dxxxx's current limiters' fold back circuit also operates as a short circuit protect function for the output current limiter. This high level of output stability is maintained even during frequent load fluctuations, due to the excellent transient response performance and high PSRR achieved across a broad range of frequencies. The output voltage for each of the dual internal regulators is fully independent. The device has independent enable pins to shutdown each internal regulator, resulting in greatly reduced power consumption.

Pin Assignment

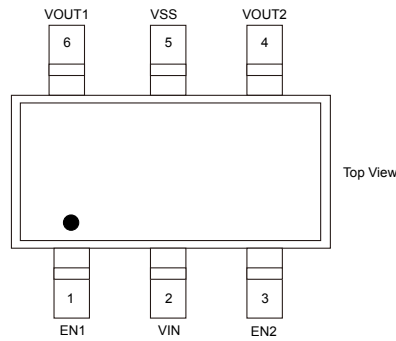

Pin Assignment		
Pin	Name	Pin Description
1	EN1	Regulator 1 Enable - high enable
2	V _{IN}	Input Pin
3	EN2	Regulator 2 Enable - high enable
4	V _{OUT2}	Regulator 2 Output
5	V _{SS}	Ground Pin
6	V _{OUT1}	Regulator 1 Output

Block Diagram

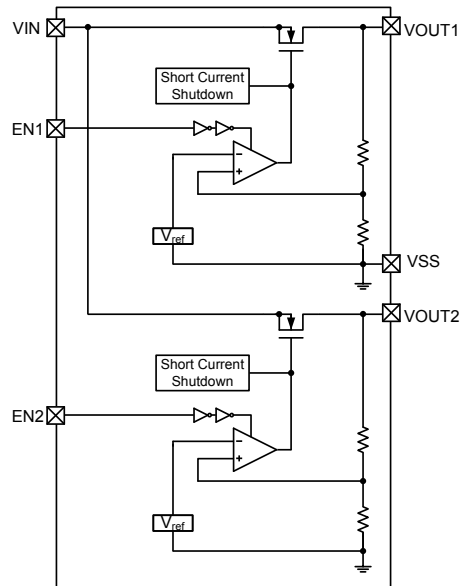

Absolute Maximum Ratings (Note 1)

Maximum Input Supply Voltage.....	7.5V
V _{OUT1} , V _{OUT2} to V _{SS}	V _{SS} - 0.3V ~ V _{IN} + 0.3V
Power Dissipation.....	250mW
Ambient Temperature Range.....	-40°C ~ +85°C
Junction Temperature.....	+150°C
Storage Temperature Range.....	-55°C ~ +125°C

ELECTRICAL CHARACTERISTICS

$T_J=25^{\circ}\text{C}$, $V_{IN}=V_{OUT}+1.0\text{V}$, $I_{OUT}=30\text{mA}$, unless otherwise specified (Note 2)

Symbol	Parameter	Test Conditions	Min.	Typ.	Max.	Unit	
V_{IN}	Input Voltage	—	2.5	—	7	V	
V_{OUT}	Output Voltage Tolerance	$I_{OUT}=30\text{mA}$	-2	—	+2	%	
I_{OUT}	Maximum Output Current(Note 3)	I_{OUT1} , I_{OUT2}	300	—	—	mA	
ΔV_{LINE}	Line Regulation	$V_{OUT}+0.5\text{V}\leq V_{IN}\leq 7\text{V}$ $I_{OUT}=10\text{mA}$	—	0.02	0.1	%/V	
ΔV_{LOAD}	Load Regulation (Note 4)	$1\text{mA}\leq I_{OUT}\leq 300\text{mA}$	$1.5\text{V}\leq V_{OUT}\leq 1.8\text{V}$	—	10	20	mV
			$2.5\text{V}\leq V_{OUT}\leq 3.0\text{V}$	—	15	30	
			$3.3\text{V}\leq V_{OUT}\leq 5.0\text{V}$	—	20	40	
V_{DROPO}	Dropout Voltage (Note5)	$\Delta V_{OUT}=2\%$ $I_{OUT}=300\text{mA}$	$1.5\text{V}\leq V_{OUT}\leq 1.8\text{V}$	—	0.6	0.9	V
			$2.5\text{V}\leq V_{OUT}\leq 5.0\text{V}$	—	0.34	0.64	
V_{NO}	Output Voltage Noise	Bandwidth=10Hz to 100kHz	—	30	—	μV_{RMS}	
I_{LIMIT}	Short Current Limit	$V_{OUT}=0\text{V}$	—	90	—	mA	
I_{SS}	Supply Current	$I_{OUT}=0\text{mA}$, $V_{EN1}=V_{EN2}=V_{IN}$	—	30	50	μA	
I_{DS}	Shutdown Current	$V_{EN1}=V_{EN2}=V_{SS}$	—	0.1	1	μA	
V_{IH}	EN Input High Voltage	$V_{OUT}+1\text{V}\leq V_{IN}\leq 7\text{V}$	2.0	—	—	V	
V_{IL}	EN Input Low Voltage	$V_{OUT}+1\text{V}\leq V_{IN}\leq 7\text{V}$	—	—	0.4		
RR	Ripple Rejection	$I_{OUT}=30\text{mA}$	f=1kHz	—	70	—	dB
			f=10kHz	—	53	—	
$\frac{\Delta V_{OUT}}{\Delta T_a \cdot V_{OUT}}$	Temperature Coefficient	$-40^{\circ}\text{C}<T_a<85^{\circ}\text{C}$	—	± 100	—	ppm/ $^{\circ}\text{C}$	
T_{SD}	Thermal Shutdown Temperature	—	—	150	—	$^{\circ}\text{C}$	

Note 1. Absolute maximum ratings indicate limits beyond which damage to the device may occur. Operating Ratings indicate conditions for which the device is intended to be functional, but do not guarantee specific performance limits. The guaranteed specifications apply only for the test conditions listed.

- Specifications are production tested at T_A =room temperature. Specifications over the -40°C to 85°C operating temperature range are assured by design, characterization and correlation with Statistical Quality Controls (SQC).
- The input/output differential voltage multiplied by the output current must be less than than the package power dissipation value of 250mW.
- Load regulation is measured at constant junction temperature, using pulse testing with a short ON time. The devices are guaranteed up to the maximum power dissipation. Power dissipation is determined by the input/output differential voltage and the output current. Guaranteed maximum power dissipation will not be available over the full input/output range. The maximum allowable power dissipation at any ambient temperature is $P_D = (T_{J(MAX)} - T_A)/\theta_{JA}$.
- Dropout voltage is the minimum input to output voltage differential needed to maintain regulation at a specified output current. During dropout conditions, the output voltage will be equal to: $V_{IN} - V_{DROPO}$.

Output Voltage Selector Guide

Type Code

Part No.	Mark	Output Voltage		Package
		Out 1	Out 2	
HT72D1518	2D1518	1.5	1.8	SOT23-6
HT72D1525	2D1525	1.5	2.5	
HT72D1528	2D1528	1.5	2.8	
HT72D1533	2D1533	1.5	3.3	
HT72D1825	2D1825	1.8	2.5	
HT72D1828	2D1828	1.8	2.8	
HT72D1830	2D1830	1.8	3.0	
HT72D1833	2D1833	1.8	3.3	
HT72D2528	2D2528	2.5	2.8	
HT72D2533	2D2533	2.5	3.3	
HT72D2833	2D2833	2.8	3.3	
HT72D3033	2D3033	3.0	3.3	

Note: The devices are all green compound devices which are Lead-free and Halogen-free.

Typical Application Circuit

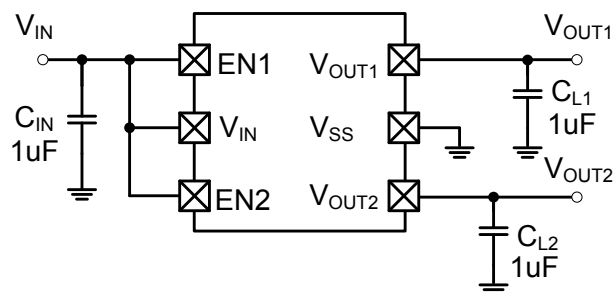

HT72Dxxxx

Typical Characteristics

Output Voltage vs. Input Voltage

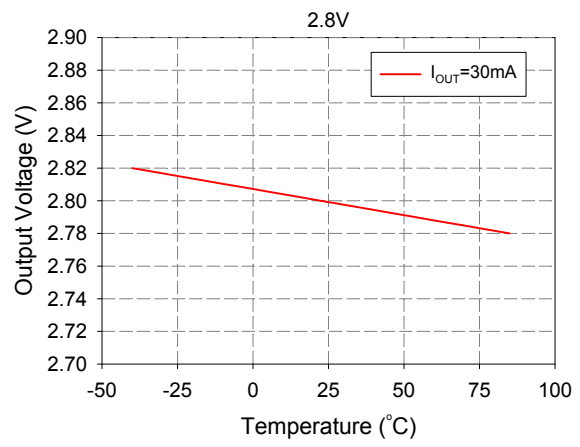
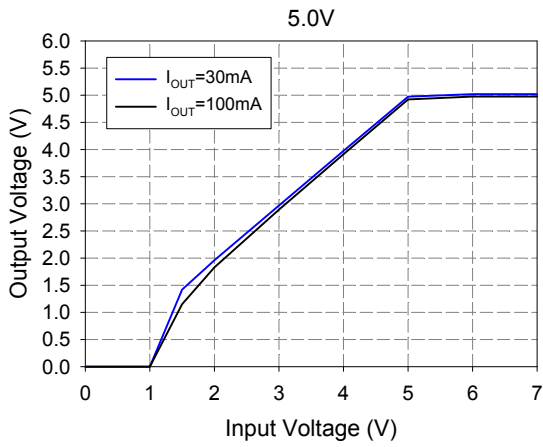
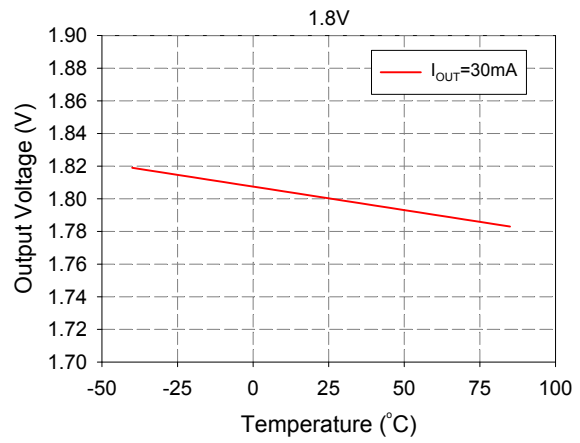
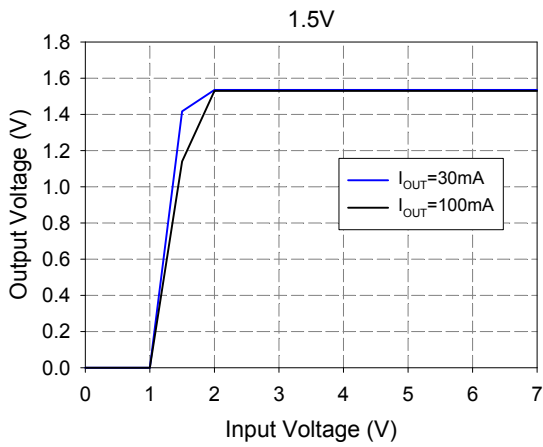

Output Voltage vs. Temperature

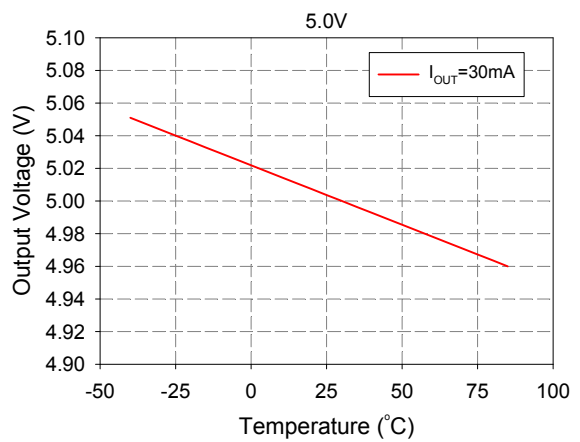
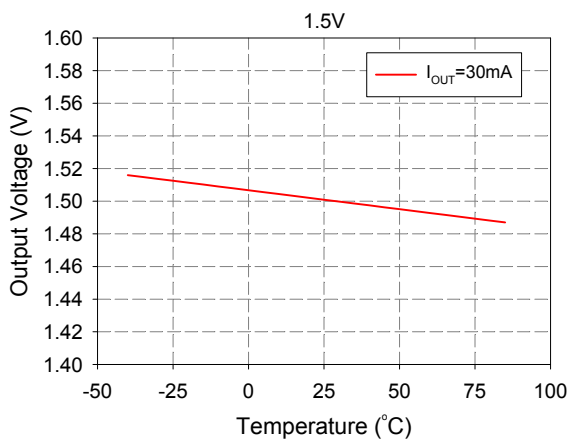

Supply Current vs. Temperature

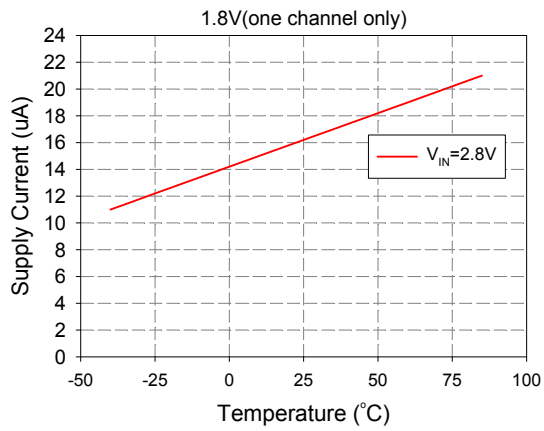
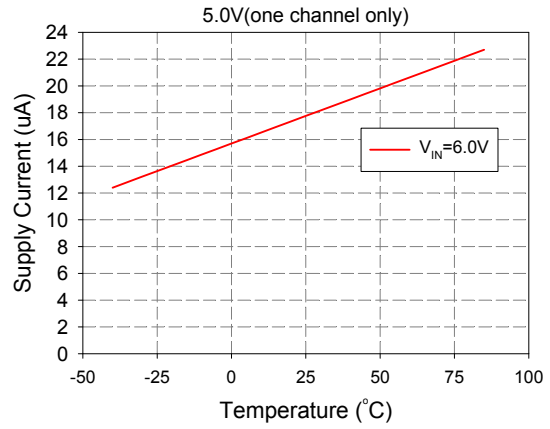
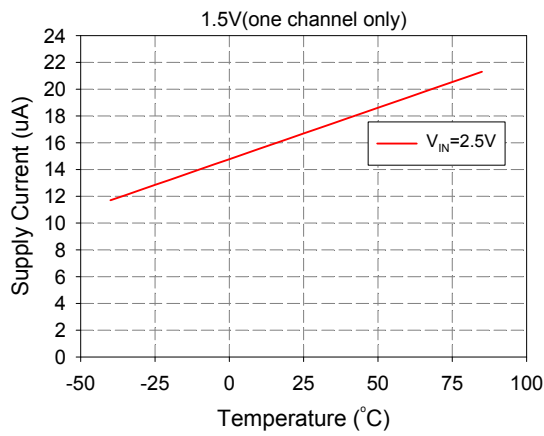

Dropout Voltage vs. Output Current

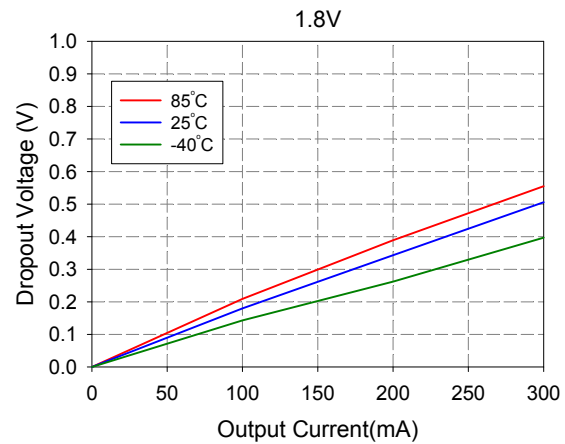
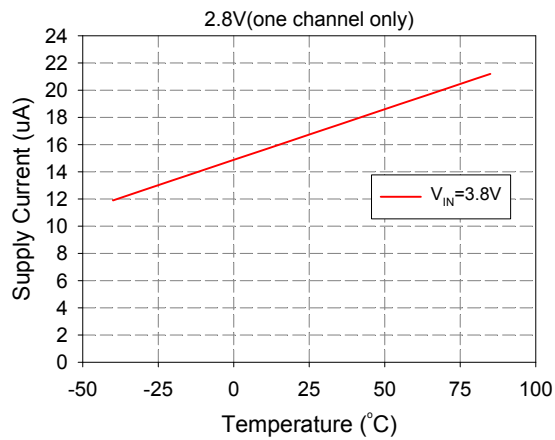
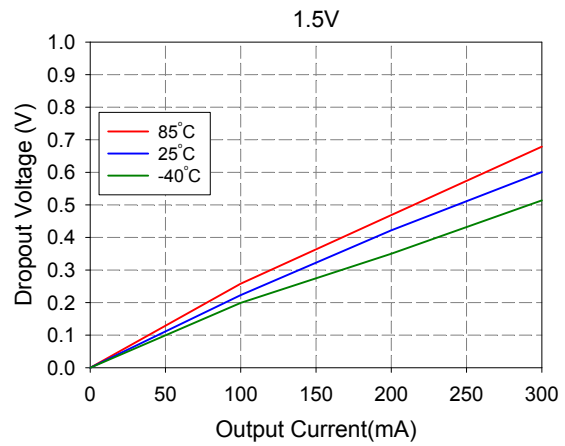

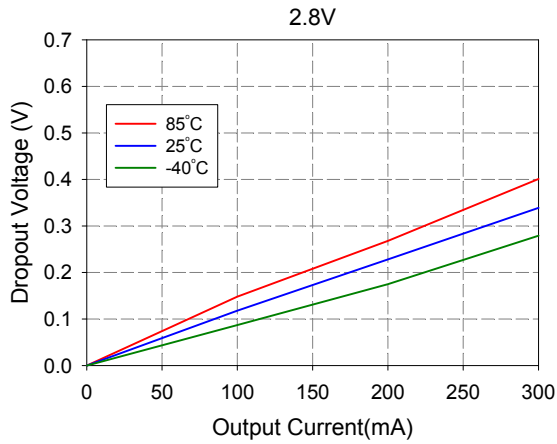

Ripple Rejection vs. Frequency

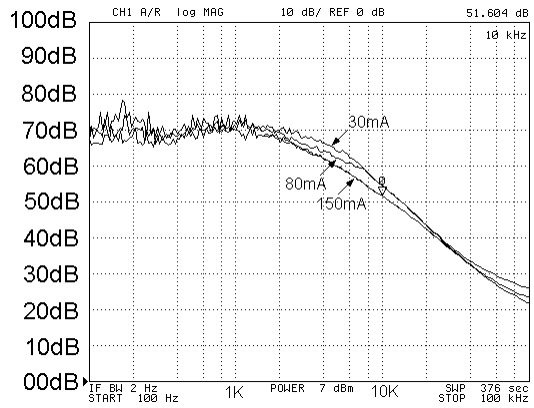

HT72Dxxxx $V_{OUT}=1.5V$ $V_{IN}=2.5V$ ($I_{OUT}=30, 80, 150mA$)

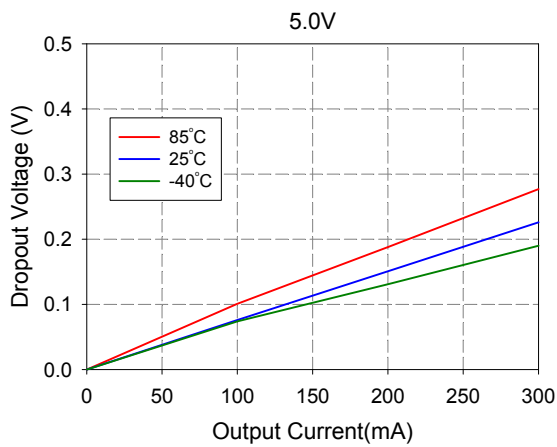

Load Transient Response

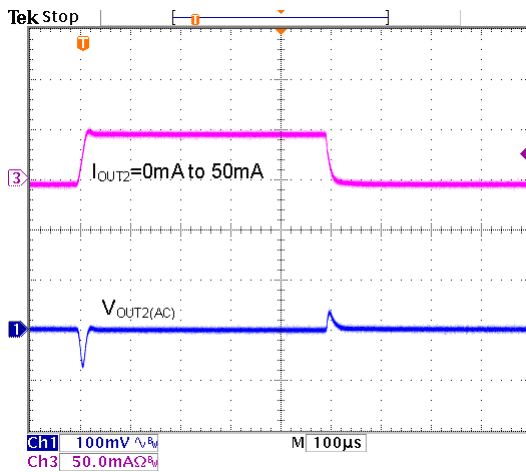

HT72D5015 $V_{OUT2}=1.5V$ $V_{IN}=2.5V$
 $C_{IN}=C_{OUT2}=1\mu F$ $V_{EN1}=0V$ $V_{EN2}=V_{IN}$

Supply Current vs. Input Voltage

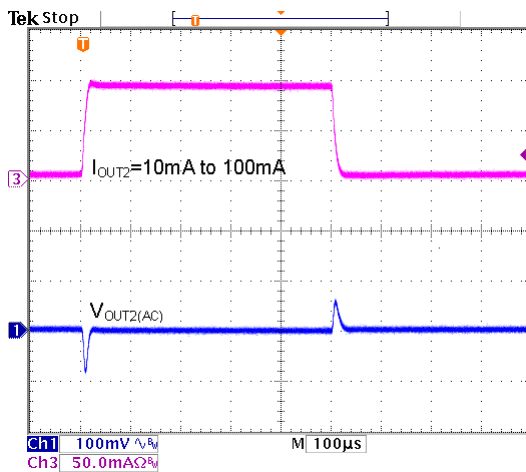
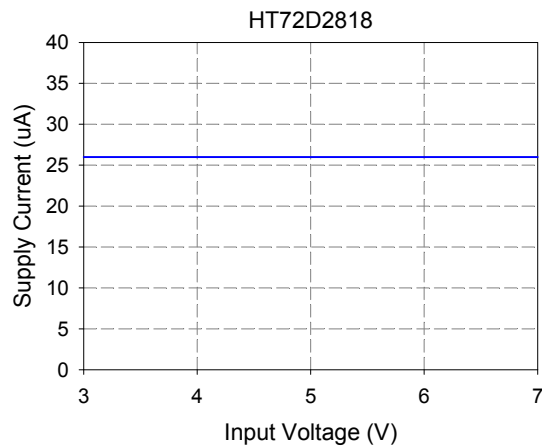

HT72D5015 $V_{OUT2}=1.5V$ $V_{IN}=2.5V$
 $C_{IN}=C_{OUT2}=1\mu F$ $V_{EN1}=0V$ $V_{EN2}=V_{IN}$

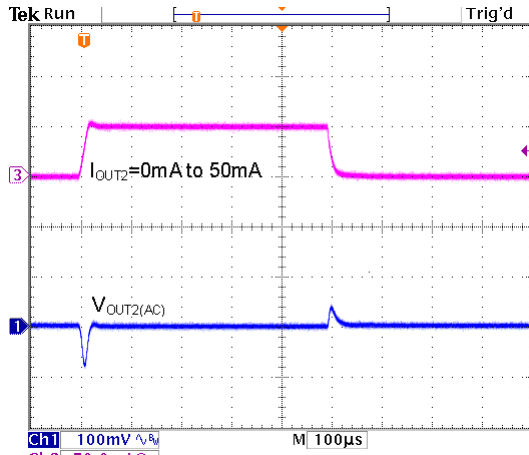

HT72D2818 V_{OUT2}=1.8V V_{IN}=2.8V
C_{IN}=C_{OUT2}=1 μ F V_{EN1}=0V V_{EN2}=V_{IN}

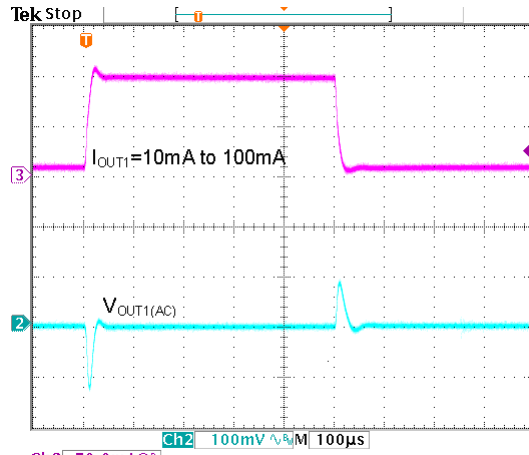

HT72D2818 V_{OUT1}=2.8V V_{IN}=3.8V
C_{IN}=C_{OUT1}=1 μ F V_{EN1}=V_{IN} V_{EN2}=0V

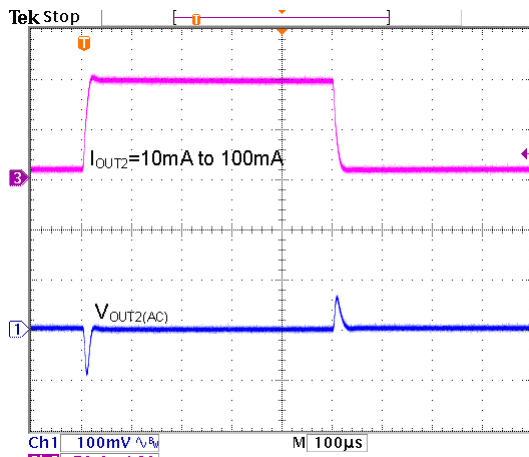

HT72D2818 V_{OUT2}=1.8V V_{IN}=2.8V
C_{IN}=C_{OUT2}=1 μ F V_{EN1}=0V V_{EN2}=V_{IN}

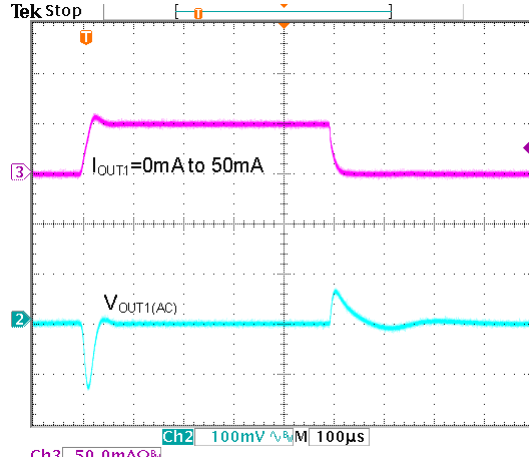

HT72D5015 V_{OUT1}=5.0V V_{IN}=6.0V
C_{IN}=C_{OUT1}=1 μ F V_{EN1}=V_{IN} V_{EN2}=0V

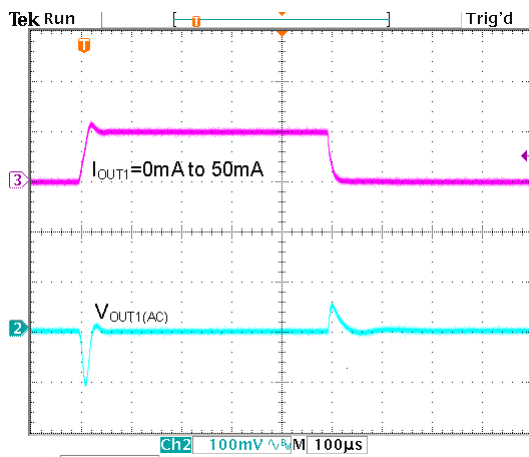

HT72D2818 V_{OUT1}=2.8V V_{IN}=3.8V
C_{IN}=C_{OUT1}=1 μ F V_{EN1}=V_{IN} V_{EN2}=0V

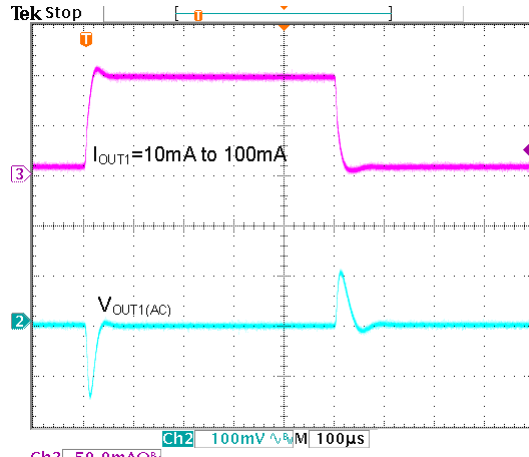

HT72D5015 V_{OUT1}=5.0V V_{IN}=6.0V
C_{IN}=C_{OUT1}=1 μ F V_{EN1}=V_{IN} V_{EN2}=0V

Input Transient Response

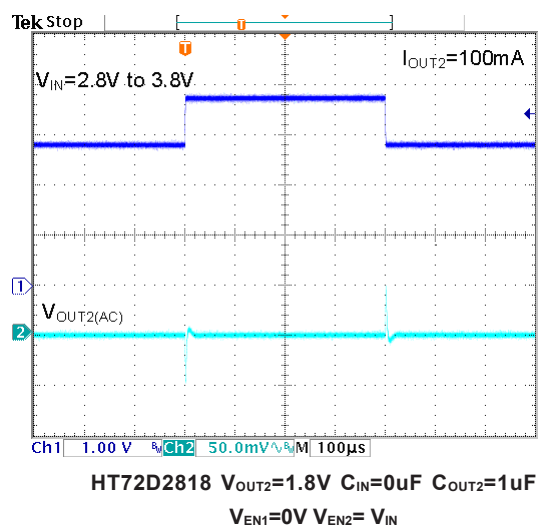
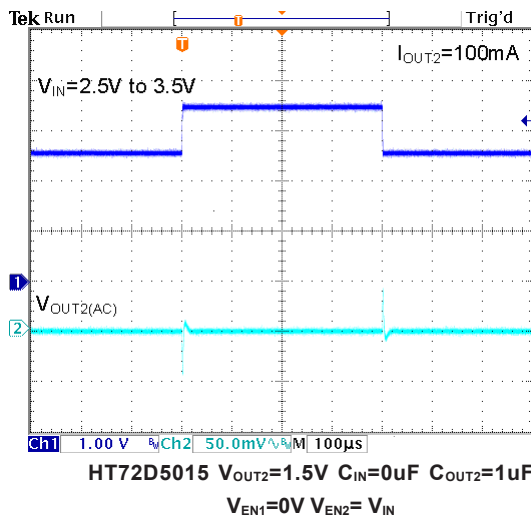
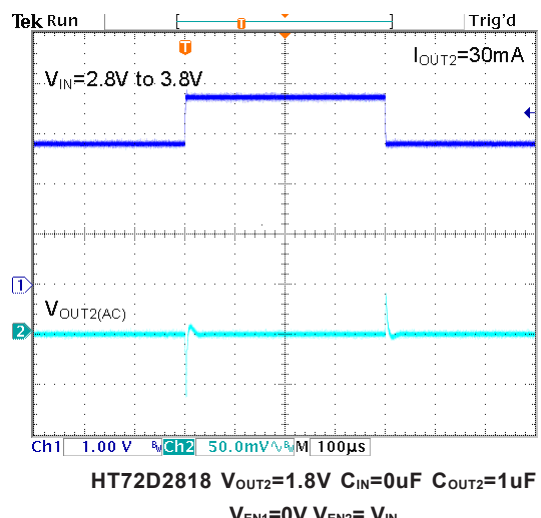
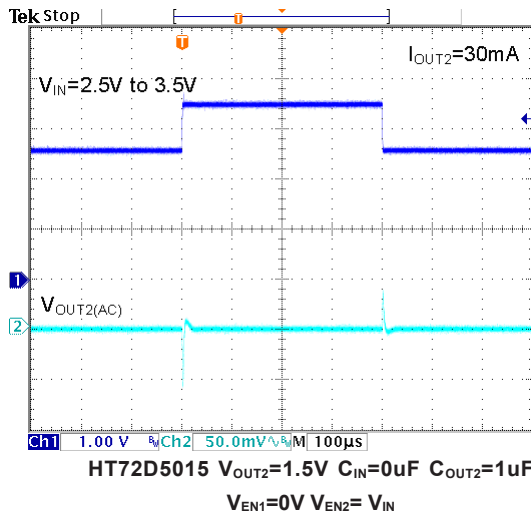
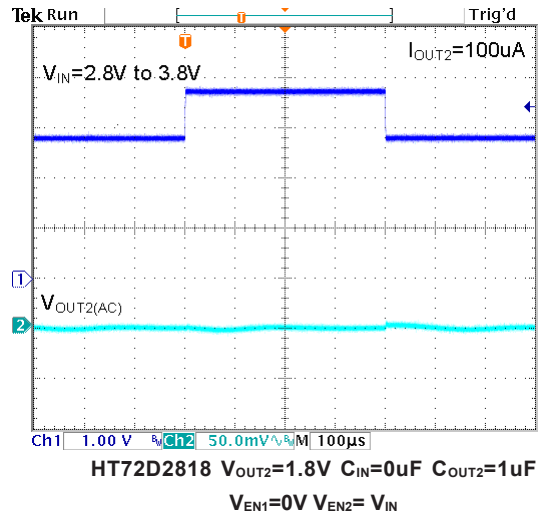
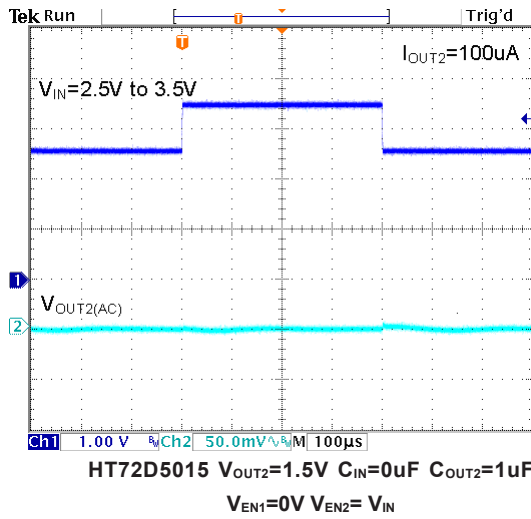

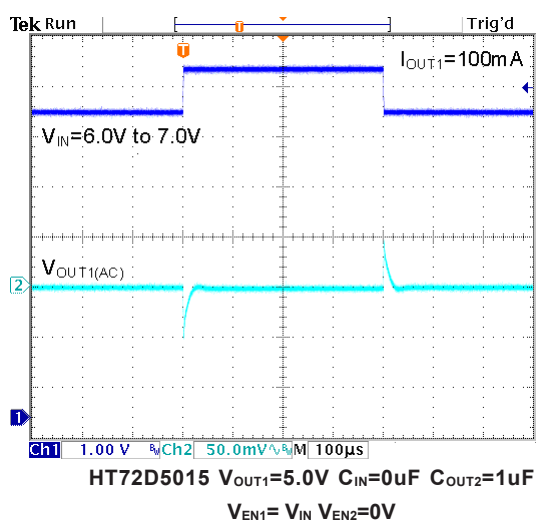
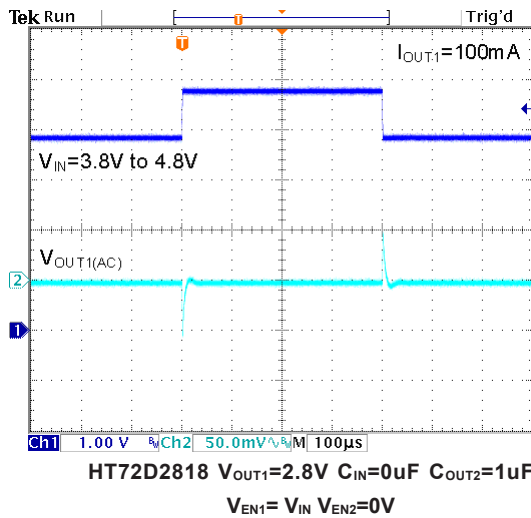
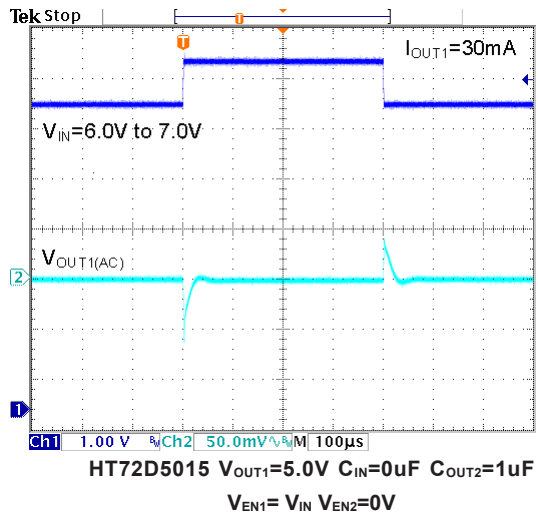
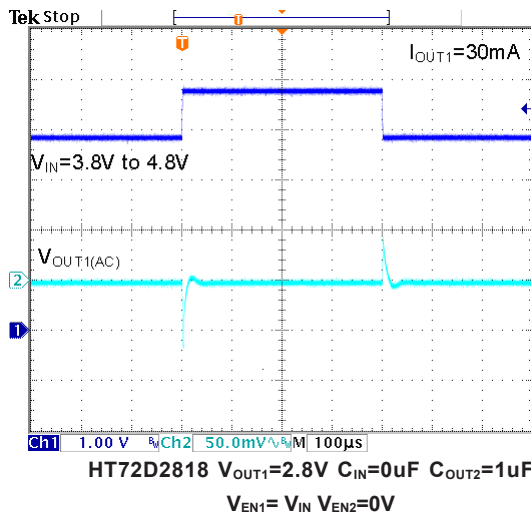
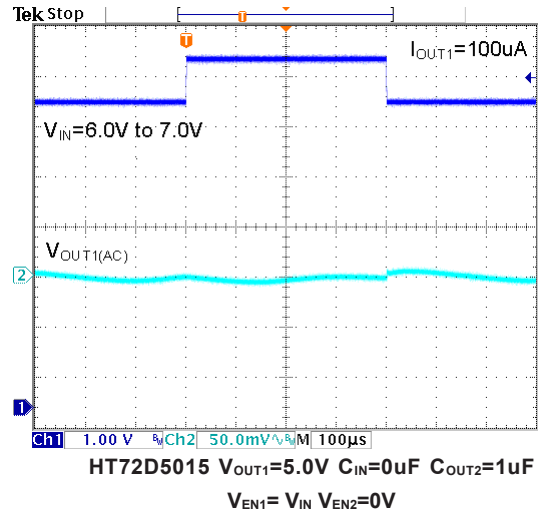
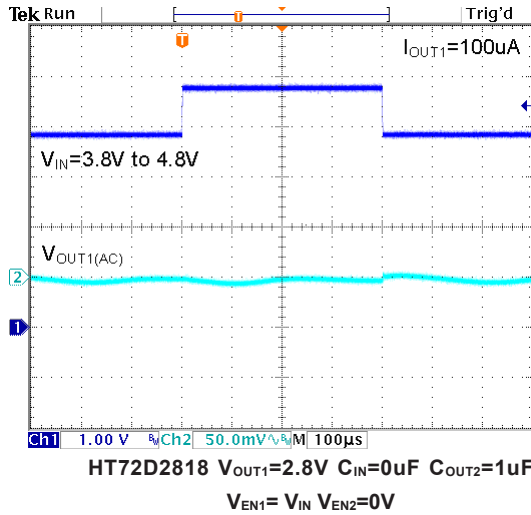

Package Information

Note that the package information provided here is for consultation purposes only. As this information may be updated at regular intervals users are reminded to consult the Holtek website (<http://www.holtek.com.tw/english/literature/package.pdf>) for the latest version of the package information.

6-pin SOT23-6 Outline Dimensions

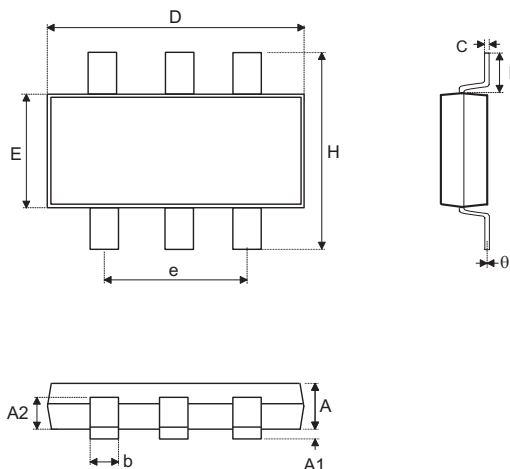

Symbol	Dimensions in inch		
	Min.	Nom.	Max.
A	0.039	—	0.051
A1	—	—	0.004
A2	0.028	—	0.035
b	0.014	—	0.020
C	0.004	—	0.010
D	0.106	—	0.122
E	0.055	—	0.071
e	—	0.075	—
H	0.102	—	0.118
L	0.015	—	—
θ	0°	—	9°

Symbol	Dimensions in mm		
	Min.	Nom.	Max.
A	1.00	—	1.30
A1	—	—	0.10
A2	0.70	—	0.90
b	0.35	—	0.50
C	0.10	—	0.25
D	2.70	—	3.10
E	1.40	—	1.80
e	—	1.90	—
H	2.60	—	3.00
L	0.37	—	—
θ	0°	—	9°

Reel Dimensions

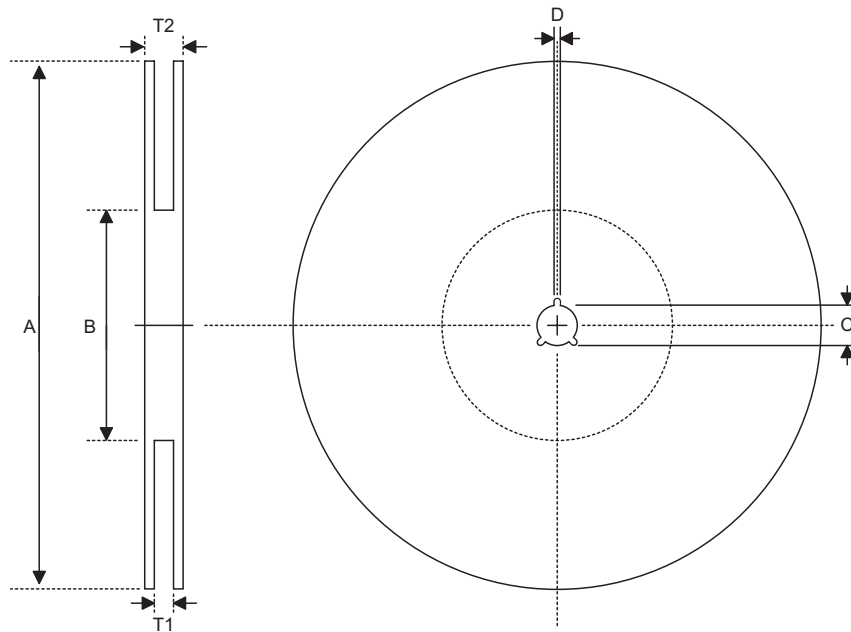

6-pin SOT23-6

Symbol	Description	Dimensions in mm
A	Reel Outer Diameter	178.0±1.0
B	Reel Inner Diameter	62.0±1.0
C	Spindle Hole Diameter	13.0±0.2
D	Key Slit Width	2.50±0.25
T1	Space Between Flang	8.4 ^{+1.5/-0.0}
T2	Reel Thickness	11.4 ^{+1.5/-0.0}

Carrier Tape Dimensions

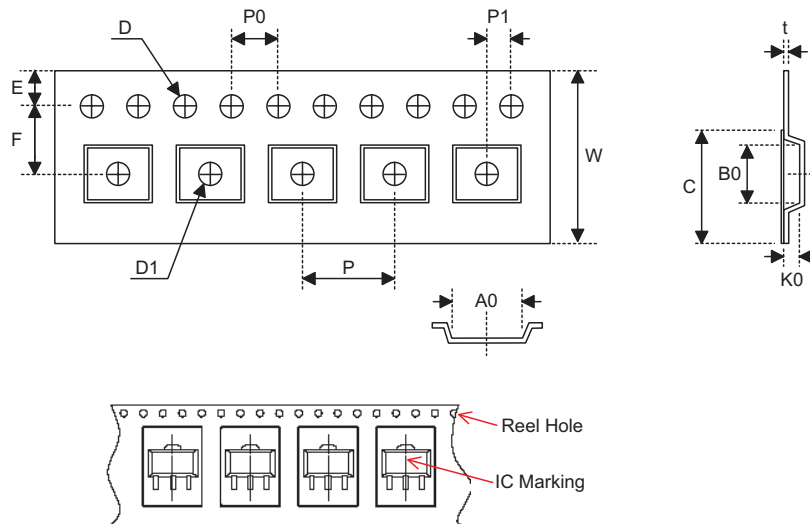

6-pin SOT23-6

Symbol	Description	Dimensions in mm
W	Carrier Tape Width	8.0±0.3
P	Cavity Pitch	4.0±0.1
E	Perforation Position	1.75±0.10
F	Cavity to Perforation(Width Direction)	3.50±0.05
D	Perforation Diameter	1.5 ^{+0.1/-0.0}
D1	Cavity Hole Diameter	1.5 ^{+0.1/-0.0}
P0	Perforation Pitch	4.0±0.1
P1	Cavity to Perforation(Length Direction)	2.00±0.05
A0	Cavity Length	3.15±0.10
B0	Cavity Width	3.2±0.1
K0	Cavity Depth	1.4±0.1
t	Carrier Tape Thickness	0.20±0.03
C	Cover Tape Width	5.3±0.1

Holtek Semiconductor Inc. (Headquarters)

No.3, Creation Rd. II, Science Park, Hsinchu, Taiwan
Tel: 886-3-563-1999
Fax: 886-3-563-1189
<http://www.holtek.com.tw>

Holtek Semiconductor Inc. (Taipei Sales Office)

4F-2, No. 3-2, YuanQu St., Nankang Software Park, Taipei 115, Taiwan
Tel: 886-2-2655-7070
Fax: 886-2-2655-7373
Fax: 886-2-2655-7383 (International sales hotline)

Holtek Semiconductor Inc. (Shenzhen Sales Office)

5F, Unit A, Productivity Building, No.5 Gaoxin M 2nd Road, Nanshan District, Shenzhen, China 518057
Tel: 86-755-8616-9908, 86-755-8616-9308
Fax: 86-755-8616-9722

Holtek Semiconductor (USA), Inc. (North America Sales Office)

46729 Fremont Blvd., Fremont, CA 94538, USA
Tel: 1-510-252-9880
Fax: 1-510-252-9885
<http://www.holtek.com>

Copyright© 2011 by HOLTEK SEMICONDUCTOR INC.

The information appearing in this Data Sheet is believed to be accurate at the time of publication. However, Holtek assumes no responsibility arising from the use of the specifications described. The applications mentioned herein are used solely for the purpose of illustration and Holtek makes no warranty or representation that such applications will be suitable without further modification, nor recommends the use of its products for application that may present a risk to human life due to malfunction or otherwise. Holtek's products are not authorized for use as critical components in life support devices or systems. Holtek reserves the right to alter its products without prior notification. For the most up-to-date information, please visit our web site at <http://www.holtek.com.tw>.