

30W内置升压单声道D类/AB类音频功放

30W Boosted Mono Class D/AB Amplifier

FEATURES

- Anti-Clipping Function (ACF)
- Spread spectrum technology
- Output Power
 - 28W ($V_{BAT}=7.2V$, $R_L=4\Omega$, THD+N=10%, PVDD = 15.5V, $f_{IN} = 1kHz$)
 - 22W ($V_{BAT}=7.2V$, $R_L=4\Omega$, THD+N=1%, PVDD = 15.5V, $f_{IN} = 1kHz$)
 - 16.5W ($V_{BAT}=3.7V$, $R_L=4\Omega$, THD+N=10%, PVDD = 12V, $f_{IN} = 1kHz$)
 - 12.8W ($V_{BAT}=3.7V$, $R_L=4\Omega$, THD+N=1%, PVDD = 12V, $f_{IN} = 1kHz$)
- Power Supply V_{BAT} : 3.0V~12V
- Integrates High Efficiency Boost Converter
 - Adjustable voltage by external resistor
 - Adjustable switch peak current limit to avoid over-pulling on battery current
- Both Class D and Class AB are available
- Over Current Protection, Thermal Protection, over voltage protection function included
- Pb-Free Packages, ESOP16
- 防削顶失真功能(防破音, Anti-Clipping Function, ACF)
- 扩频技术
- 输出功率
 - 28W ($V_{BAT}=7.2V$, $R_L=4\Omega$, THD+N=10%, PVDD = 15.5V, $f_{IN} = 1kHz$)
 - 22W ($V_{BAT}=7.2V$, $R_L=4\Omega$, THD+N=1%, PVDD = 15.5V, $f_{IN} = 1kHz$)
 - 16.5W ($V_{BAT}=3.7V$, $R_L=4\Omega$, THD+N=10%, PVDD = 12V, $f_{IN} = 1kHz$)
 - 12.8W ($V_{BAT}=3.7V$, $R_L=4\Omega$, THD+N=1%, PVDD = 12V, $f_{IN} = 1kHz$)
- V_{BAT} 供电范围: 3.0V至12V
- 内置高效升压
 - 可通过外部电阻调节升压值
 - 可调节最大限流值, 有效防止电池拉死
- AB类和D类可切换
- 保护功能:过流/过热/过压保护功能
- 无铅封装, ESOP16

APPLICATIONS

- Bluetooth/Wi-Fi Speakers
- Portable Speakers
- Smart speakers
- Smart Home
- 蓝牙/ Wi-Fi音箱
- 智能音箱
- 便携式音箱
- 智能家居

■ DESCRIPTION

HT81697, integrated with a boost converter, is a mono Class D/Class AB audio amplifier that drives up to continuous 28W (10% THD+N, 1kHz) into 4ohm speaker from two Li-batteries in series boosted to 15.5V.

HT81697 integrates a boost converter that generates a power supply for the power amplifier, so that a higher power can be achieved. The output voltage of boost converter can be configured by external resistors. Configurable current limit is adopted to avoid accidental large peak current.

HT81697 features Anti-Clipping Function (ACF) which detects output signal clip due to the over input signal and suppresses the output signal clip automatically. Also, the ACF function can adapt the output clip caused by power supply voltage down with battery. It can significantly improve the sound quality, creating a very comfortable musical enjoyment, and to protect the speakers from overload damage. It supplies 3 different ACF mode with different audio experience, and also ACF OFF mode.

HT81697 integrates Spread Spectrum Control technology to achieve advanced EMI suppression. If EMI issue is highly concerned, the boost converter can be disabled and the amplifier can be switched to Class AB.

As for protection function, over current protection function for speaker output terminals, over temperature protection function and over voltage protection for boost converter output are also prepared.

HT81697是一款内置升压的单声道D类/AB类音频功率放大器，由双节锂电池串联供电升压至15.5V时，THD+N=10%，能连续输出28W功率（4Ω负载）。

HT81697内置升压，可以为内部音频功放提供一个高电压，从而实现更高功率，其升压值可通过外部电阻调节。HT81697可配置升压限流值，以防止过大的电流尖峰。

HT81697具有防削顶失真（ACF）输出控制功能，可检测并抑制由于输入音乐、语音信号幅度过大所引起的输出信号削顶失真（破音），也能自适应地防止在BOOST升压电压下降所造成的输出削顶，显著提高音质，创造非常舒适的听音享受，并保护扬声器免受过载损坏。HT81697提供三种不同音乐体验的ACF模式，以及ACF-Off 模式。

HT81697具有先进的扩频功能来抑制EMI。如果系统对EMI高度敏感，则可以将升压关闭，并将功放切换到AB类。

此外，HT81697集成了输出端过流保护、片内过温保护、升压过压保护等功能。

TYPICAL APPLICATION

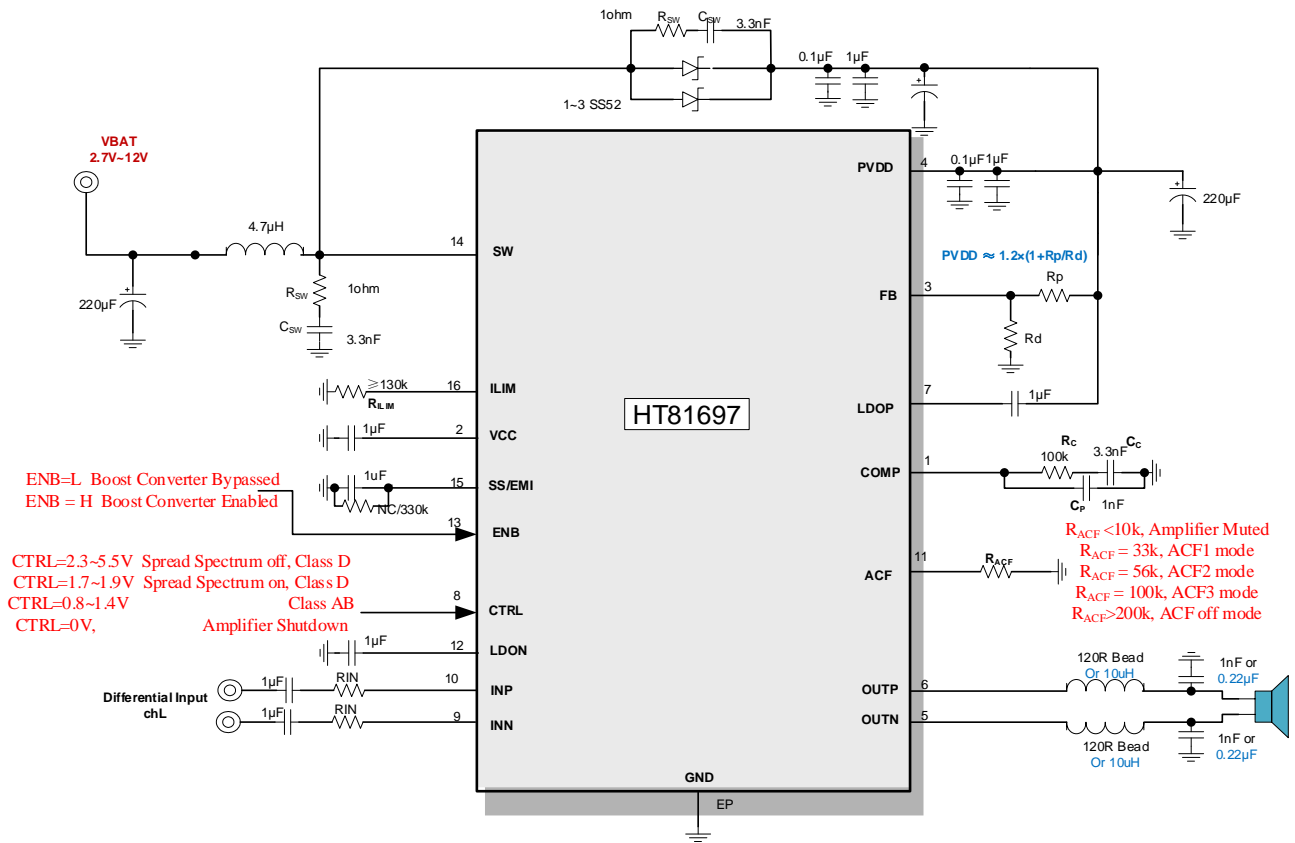

ORDERING INFORMATION

Part Number	Package Type	Marking	Operating Temperature Range	Shipping Package / MOQ
HT81697SPER	ESOP16 (SPE)	HT81697 YYYMAAB ¹	-40°C ~ 85°C	Tape and Reel (R) / 2500pcs
HT81697SPET	ESOP16 (SPE)	HT81697 YYYMAAB	-40°C ~ 85°C	Tube (T) / 50pcs

Part Number

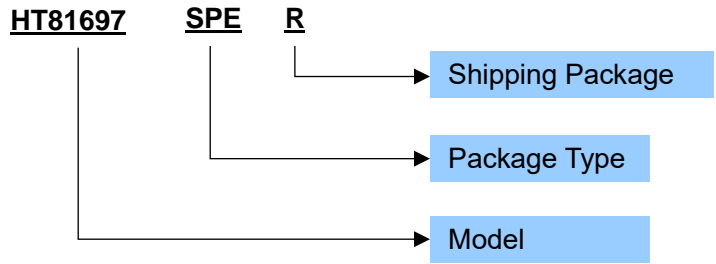

Production Tracking Code

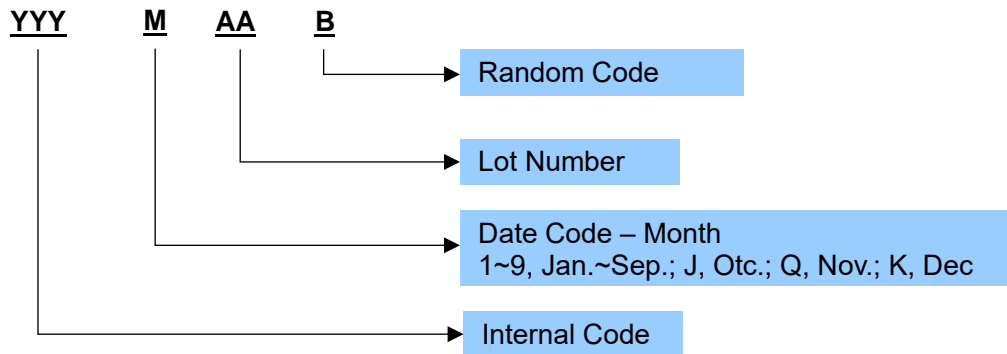

¹ YYYMAAB is production tracking code
Copyright©2023, Heroic Technology

■ TERMINAL CONFIGURATION

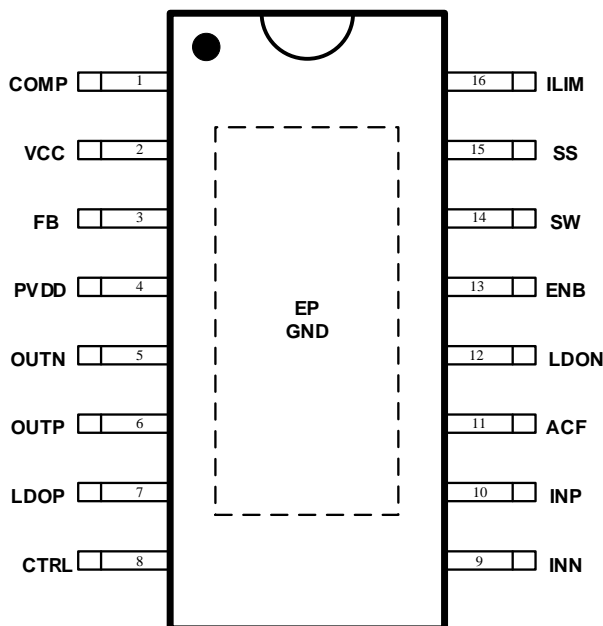

HT81697 Top View

■ TERMINAL FUNCTION

Terminal No. HT81697	Name	I/O ¹	Description
1	COMP	O	Output of the internal error amplifier, the loop compensation network should be connected between this pin and the GND pin. 环路补偿脚，接补偿电路到GND。
2	VCC	O	Voltage regulator, connect 1uF to GND. 电压调节器，接1uF到地。
3	FB	I	Voltage feedback. 电压反馈脚
4	PVDD	P	Power supply. 电源供电
5	OUTN	O	Negative pin for differential speaker amplifier. 输出负端
6	OUTP	O	Positive pin for differential speaker amplifier output. 输出正端
7	LDOP	O	Internal LDO output, connect 1uF to PVDD. 内部LDO输出，接1uF到PVDD
8	CTRL	I	Amplifier working mode selection terminal 功放工作模式设置脚
9	INN	I	Negative input (differential-) for audio amplifier. 功放输入负端
10	INP	I	Positive input (differential+) for audio amplifier. 功放输入正端
11	ACF	O	ACF mode selection terminal. ACF模式设置端
12	LDON	O	Internal LDO output, connect 1uF to GND. 内部LDO输出，接1uF到GND
13	ENB	I	Enable terminal for the boost converter. 升压使能端
14	SW	I	Boost and rectifying switch input. 升压整流开关输入端
15	SS	O	Soft-start programming pin. An external capacitor connected to ground sets the ramp rate of the internal error amplifier's reference voltage during soft-start. 升压软启动设置脚，接电容到地。 Also used as mode selection for different tr/tf of the boost converter, an external resistor 330k connected to ground selects a flatter tr/tf. 同时作为升压电路tr/tf设置脚，当同时外接1个330k电阻到地时，选择较缓的tr/tf。
16	ILIM	I	Adjustable switch peak current limit. An external resistor should be connected between this pin and GND. 最大限流值设置端，外部接电阻到地。
EP	GND	G	Provides both electrical and thermal connection from the device to the board. A matching ground pad must be provided on the PCB and the device connected to it via solder. For proper electrical operation, this ground pad must be connected to the system ground. 既是地，又是散热PAD

¹ I: Input; O: Output; G: Ground; P: Power; BST: BOOT Strap;

SPECIFICATIONS¹
Absolute Maximum Ratings²

PARAMETER	Symbol	MIN	TYP	MAX	UNIT
PVDD voltage	PVDD	-0.3		18	V
SW voltage	V _{SW}	-0.3		22	V
Input Voltages (INP, INN, CTRL, ENB)	V _I	-0.3		5.8	V
Input Voltages (ILIM, FB)		-0.3		3.6	V
Moisture Sensitivity Level (MSL)			MSL3		
Ambient Operating Temperature	T _A	-40		85	°C
Junction Temperature	T _J	-40		150	°C
Storage Temperature	T _{STG}	-40		150	°C

Recommended Operating Conditions

PARAMETER	Symbol	CONDITION	MIN	TYP	MAX	UNIT
Power supply voltage for V _{BAT}	V _{BAT}		3		12	V
Output voltage	PVDD				16	V
Ambient Operating Temperature	T _a		-40	25	85	°C
Input Voltages (INP, INN, CTRL, ENB)	V _I		0		5.0	V
Load impedance	R _L			4		Ω

Electrical Specification³

Item	Symbol	Conditions	Min.	Typ.	Max.	Unit	
Input and Output							
Input voltage for CTRL terminal	MODE1	V _{MODE1}	spread spectrum off, Class D mode	2.3		5.0	V
	MODE2	V _{MODE2}	Spread spectrum on, Class D mode	1.7		1.9	V
	MODE3	V _{MODE3}	Class AB mode	0.8		1.4	V
	MODE4	V _{MODE4}	shutdown			0.5	V
ACF pin Voltage	V _{ACF}		MUTE mode, R _{ACF} < 10k			0.5	V
			ACF1 mode, R _{ACF} = 33k	0.6		1.0	V
			ACF2 mode, R _{ACF} = 56k	1.2		2.0	V
			ACF3 mode, R _{ACF} = 100k	2.2		3.8	V
			ACF off mode, R _{ACF} > 200k	4.1			V
ENB high threshold voltage	V _{ENBH}		1.5		3.3	V	
ENB low threshold voltage	V _{ENBL}		0		0.4	V	
ENB internal pull-down resistor	R _{ENB}			800		kΩ	

¹ Depending on parts and PCB layout, characteristics may be changed.

² Stresses beyond those listed under absolute maximum ratings may cause permanent damage to the device. These are stress ratings only, and functional operation of the device at these or any other conditions beyond those indicated under recommended operating conditions is not implied. Exposure to absolute-maximum-rated conditions for extended periods may affect device reliability.

³ Depending on parts and pattern layout, characteristics may be changed.

Item	Symbol	Conditions	Min.	Typ.	Max.	Unit
BOOST Converter						
Maximum Boost converter output voltage	PVDD			16		V
Output overvoltage protection	V _{OV} P			18		V
Boost converter frequency	f _{BOOST}	V _{IN} = 3.7V, V _{OUT} = 12V		360		kHz
Under-voltage lockout (UVLO) threshold for PVDD	V _{UVLO}	Rising		2.7		V
		Falling		2.65		V
Reference voltage at the FB pin	V _{FB}			1.204		V
Soft-start charging current	I _{SS}			5		uA
VCC regulation	VCC	V _{BAT} = 3.6V, V _{OUT} = 12V, light load		5.7		V
		V _{BAT} = 3.6V, V _{OUT} = 12V, I _{LOAD} = 0.5A		5.3		V
Boost converter input current limit	I _L	R _{LIM} = 130k		13		A

Item	Symbol	Conditions	Min.	Typ.	Max.	Unit
Class D/AB Channel V _{SS} =0V, V _{BAT} =3.7 or 7.4V, PVDD = 12V or 15.6V, T _a =25°C, C _{IN} =1uF, Class D mode, ACF-Off mode, unless otherwise specified						
Carrier clock frequency	f _{PWM}	Class D mode		360		kHz
Over current protection	I _{max}	Class D mode		8		A
System Gain	Gain	R _{in} = 0kΩ		36		dB
		R _{in} = 20kΩ		26		dB
Common mode rejection ratio	CMRR	V _{IC} = 0.1V, PVDD = 12V		-65		dB
Start-up time (power-on or shutdown release)	t _{STUP}			170		ms
Turn-off time	t _{off}	Pull CTRL low		5		us
Delay time of MUTE	t _{MUTE}	Pull ACF low		22		us
Quiescent supply current	I _{DD}	V _{BAT} = 3.6V, Class D, Boost disabled		4.3		mA
		V _{BAT} = 7.4V, Class D, Boost disabled		7.1		mA
		V _{BAT} = 3.6V, Class AB, Boost disabled		13		mA
		V _{BAT} = 7.4V, Class AB, Boost disabled		16		mA
Quiescent supply current in MUTE mode	I _{MUTE}	V _{BAT} = 7.4V, Class D		4		mA
		V _{BAT} = 7.4V, Class AB		2.7		mA
Quiescent supply current in shutdown mode	I _{SD}	V _{BAT} = 7.4V, with FB resistor consumption		40		uA
ACF attenuation gain	A _a		-16		0	dB
LDO output voltage	LDON	PVDD = 12V, working on		5		V
		PVDD = 12V, shutdown		4.4		V
	LDOP	PVDD = 12V, working on		7		V
		PVDD = 12V, shutdown		11.9		V
Input Bias Voltage	V _{INBIAS}			1.65		V
Total Harmonic Distortion plus Noise	THD+N	P _O =1.0W, R _L =4Ω, f=1kHz, Class D		0.12		%
		P _O =1.0W, R _L =4Ω, f=1kHz, Class AB, Boost disabled		0.35		%
Output Noise	V _N	f=20Hz~20kHz, A weighted, A _v =26dB		115		μV _{rms}

Output offset voltage	V _{os}			±1.5		mV
Output Power in Class D Mode	P _o	THD+N=10%	V _{BAT} =3.7V, f=1kHz, R _L =4Ω PVDD = 12V	16.6		W
		THD+N=1%		12.8		
		THD+N=10%	V _{BAT} =7.2V, f=1kHz, R _L =4Ω PVDD = 15.5V	28		
		THD+N=1%		22		
Output Power in Class AB Mode	P _o	THD+N=10%	V _{BAT} =3.7V, f=1kHz, R _L =4Ω Boost Disabled	1.6		
		THD+N=10%	V _{BAT} =7.4V, f=1kHz, R _L =4Ω Boost Disabled	7.5		
Efficiency (Class D + Boost)	η	V _{BAT} =3.7V, R _L =4Ω+22uH, THD+N = 10%, PVDD=12V		72		%
		V _{BAT} =7.4V, R _L =4Ω+22uH, THD+N = 10%, PVDD=16V		78		%
Efficiency in Class AB	η	V _{BAT} =3.7V, R _L =4Ω+22uH, THD+N = 10%, Boost Disabled		73		%
		V _{BAT} =7.4V, R _L =4Ω+22uH, THD+N = 10%, Boost Disabled		76		%

TYPICAL OPERATING CHARACTERISTICS

Class D Mode

Quiescent Current

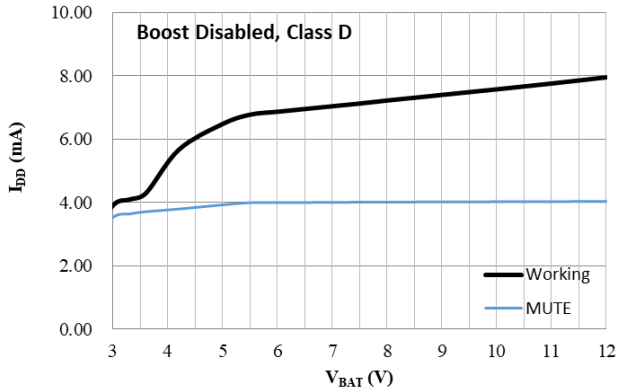

Shutdown Current

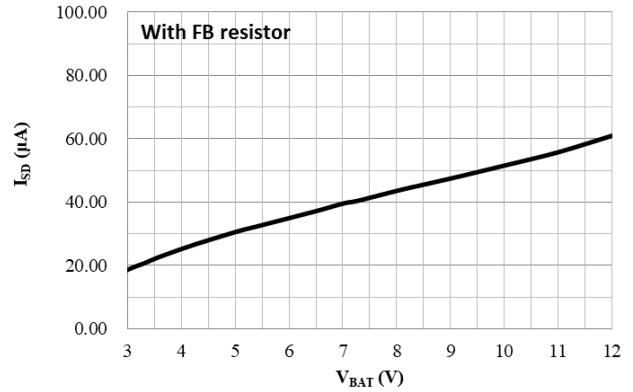

P_O vs η

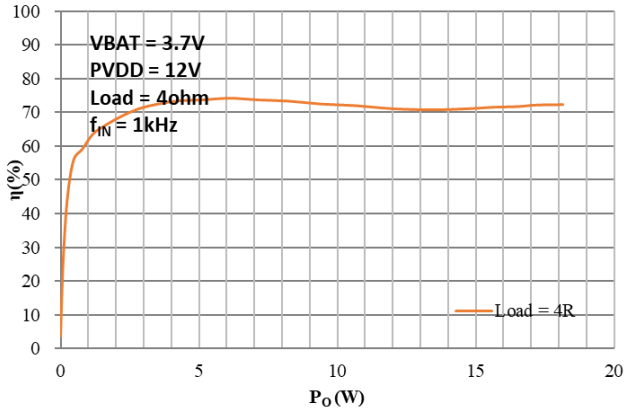

P_O vs η

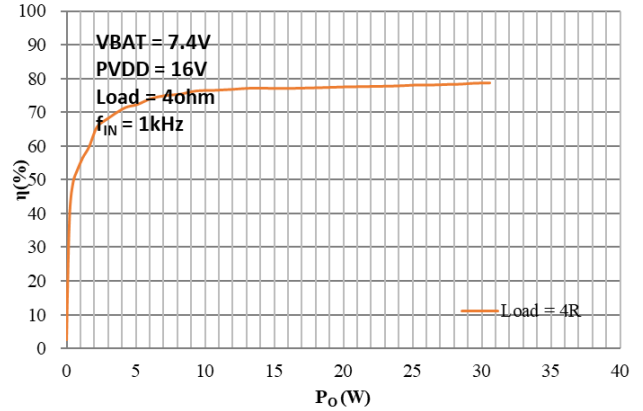

V_{BAT} = 4V, R_L = 4ohm, f_{IN} = 1kHz, R_{LIM} = 150k, PVDD = 12V, Class D Mode, unless otherwise specified

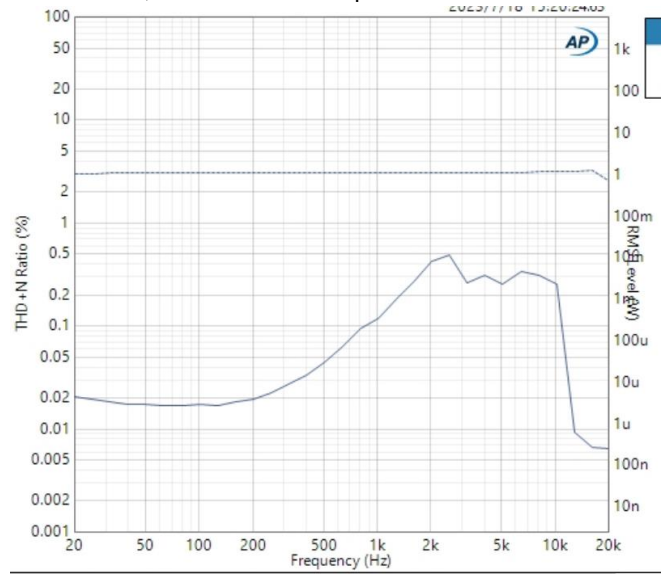
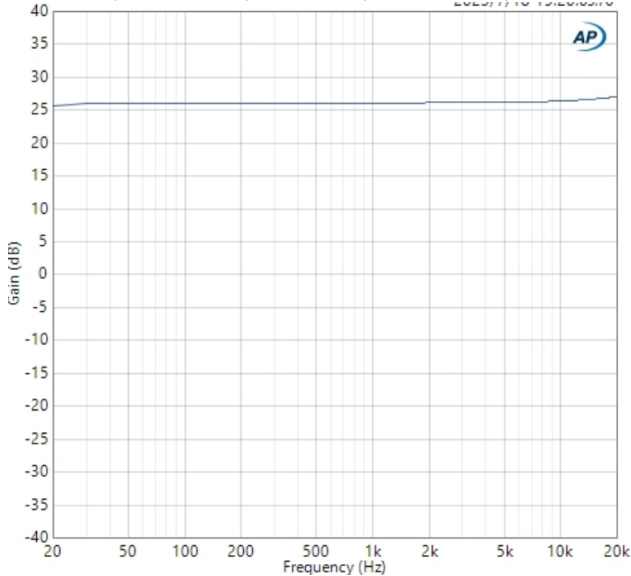

Frequency Respond
 C_{IN}=1uF, R_{IN} = 20k

frequency vs THD+N, P_O≈1W

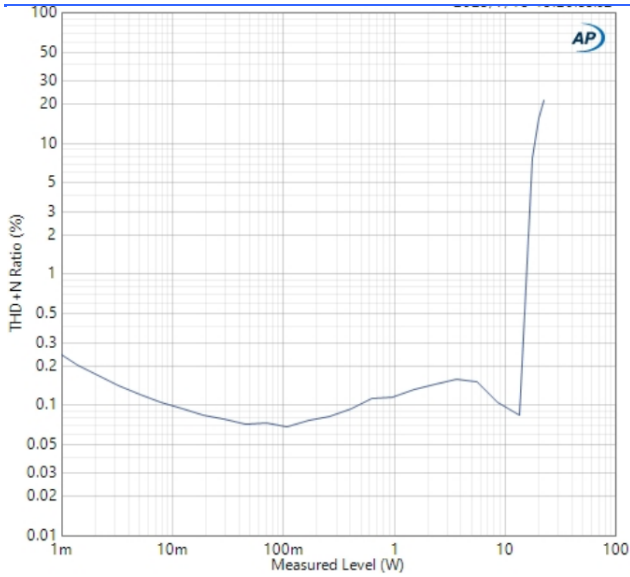

Output power vs THD+N, f = 1kHz

$V_{BAT} = 7.2V$, $R_L = 4\Omega$, $f_{IN} = 1kHz$, $R_{LIM} = 150k$, $PVDD = 15.5V$, Class D Mode, unless otherwise specified

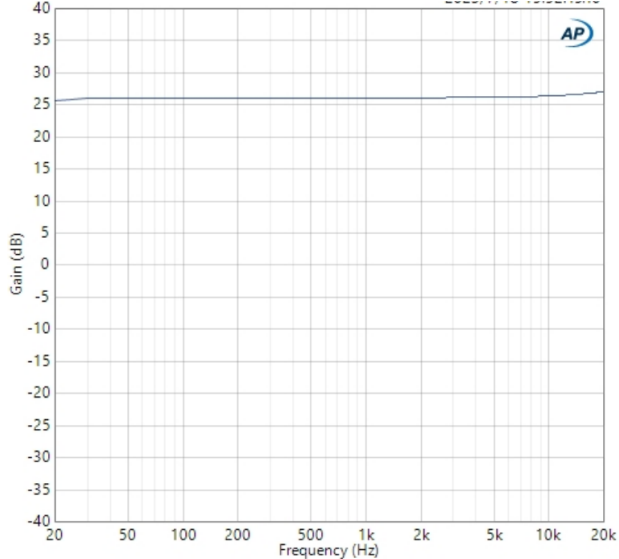

Frequency Respond
 $C_{IN}=1\mu F$, $R_{IN} = 20k$

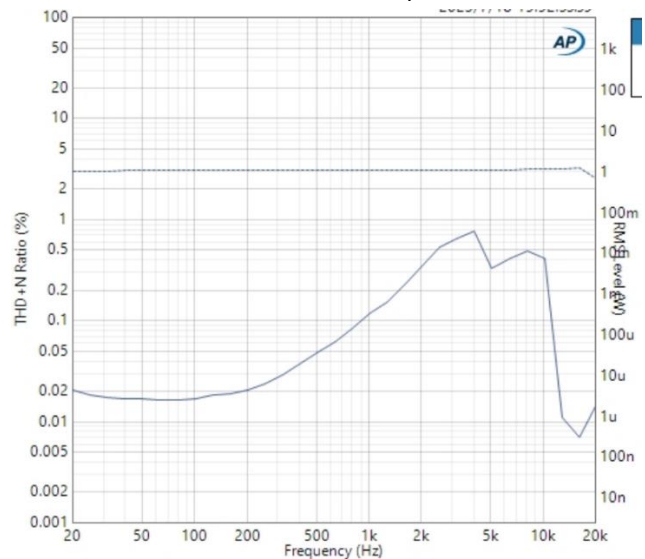

frequency vs THD+N, $P_o \approx 1W$

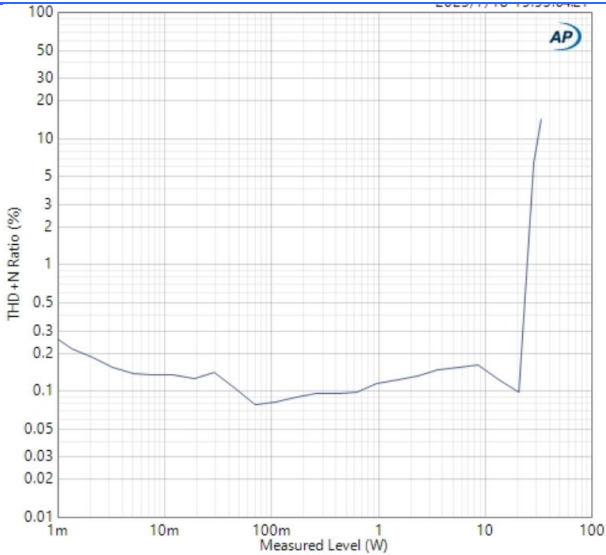

Output power vs THD+N, f = 1kHz

Class AB Mode

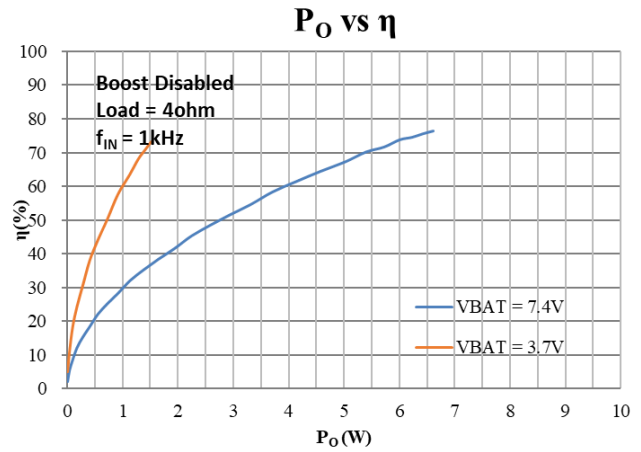
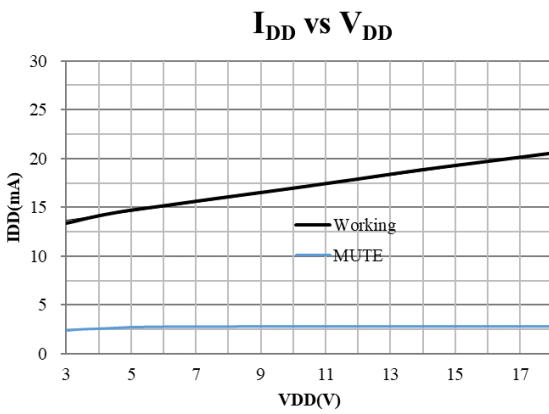

$V_{BAT} = 3.7V$, $R_L = 4\text{ohm}$, $f_{IN} = 1\text{kHz}$, Boost Disabled, Class AB Mode, unless otherwise specified

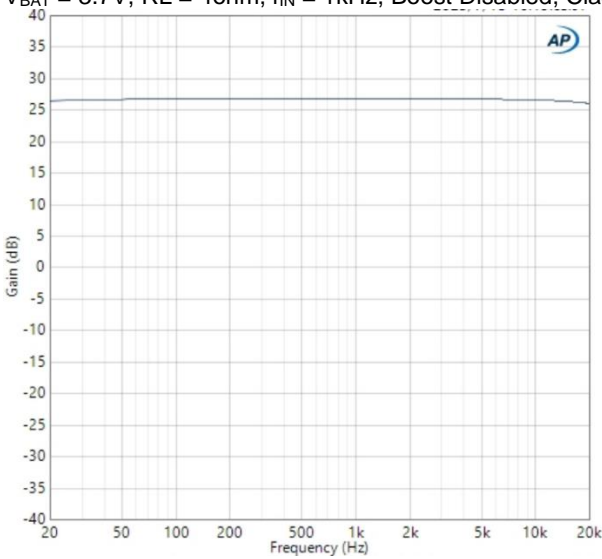

Frequency Respond
 $C_{IN}=1\mu F$, $R_{IN} = 20k$

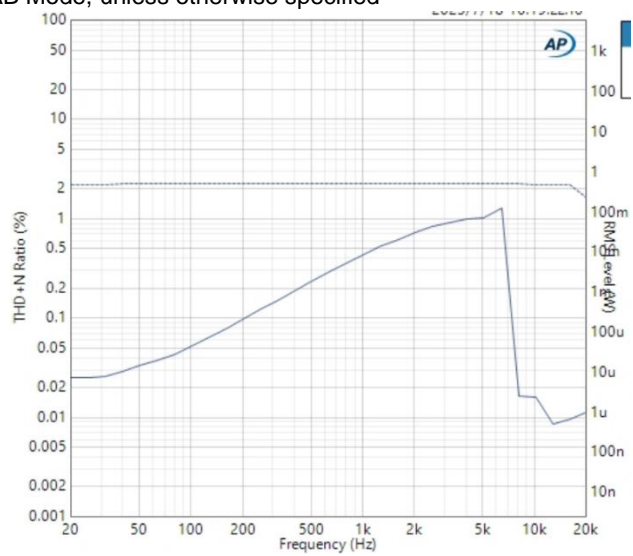

frequency vs THD+N, $P_o \approx 0.5W$

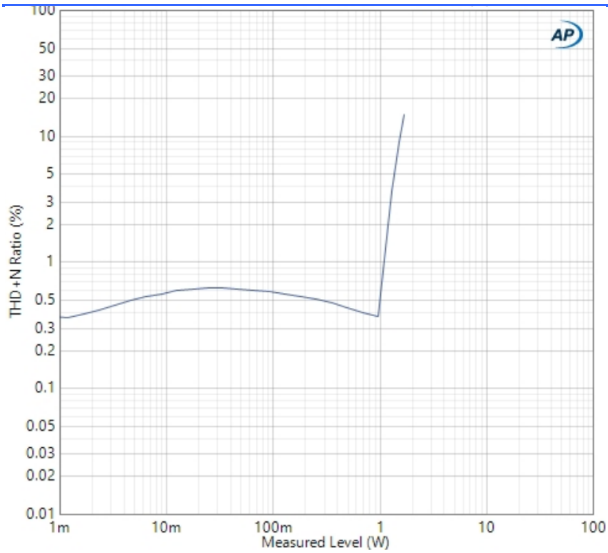

Output power vs THD+N, f = 1kHz

$V_{BAT} = 7.2V$, $R_L = 4\Omega$, $f_{IN} = 1kHz$, Boost Disabled, Class AB Mode, unless otherwise specified

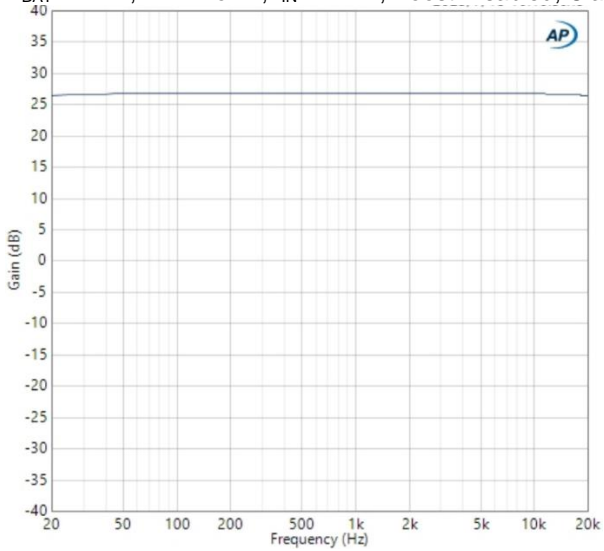

Frequency Respond
 $C_{IN}=1\mu F$, $R_{IN} = 20k$

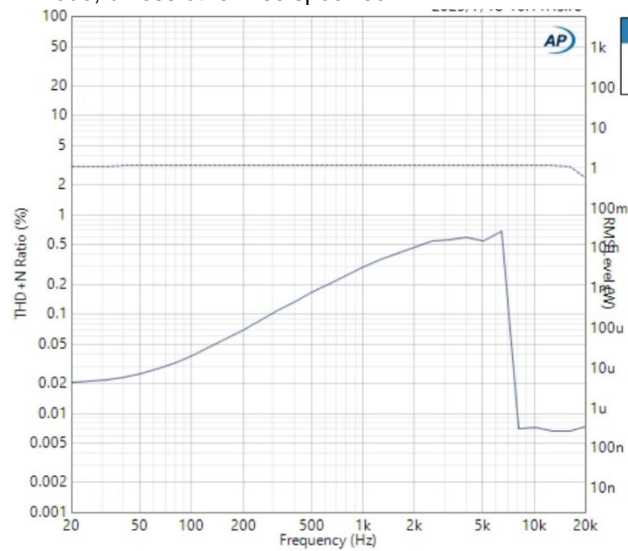

frequency vs THD+N, $P_o \approx 1W$

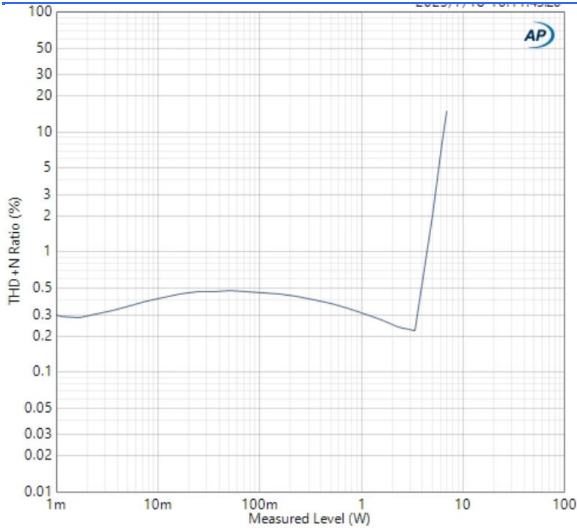

Output power vs THD+N, f = 1kHz

APPLICATION INFORMATION

1 Boost Converter

HT81697 consists of a boost converter and an audio amplifier. The boost converter takes the supply voltage, VBAT, and increases it to a higher output voltage to drives the audio amplifier. This improves loudness over non-boosted solutions. An external inductor and diode should be added for the boost converter.

The integrated boost converter operates at a quasi-constant frequency pulse width modulation (PWM) in moderate to heavy load condition. The boost converter improves the efficiency at light load with the PFM mode.

1.1 Output Voltage Setting (FB pin)

The output voltage is set by an external resistor divider (R_{UP} , R_{DN} in the Typical Application Circuit). To get the output voltage V_{OUT} , the Value of R_{UP} and R_{DN} can be calculated as:

$$V_{OUT} = V_{REF} \times \left(1 + \frac{R_{UP}}{R_{DN}}\right)$$

Where $V_{REF} = 1.204V$.

Some typical output voltages can be set as the following parameters.

Vout(V)	Rup(Ω)	Rdn(Ω)
7.4	510k	100k
9	520k	82k
12.2	510k	56k
15.5	510k	43k

1.2 ILIM

To avoid an accidental large peak current, an internal cycle-by-cycle current limit is adopted. The low-side switch is turned off immediately as soon as the switch current touches the limit. The peak switch current limit can be set by a resistor (RILIM) at the ILIM pin to ground. The relationship between the current limit and the resistance is as the following equation, or figure. The current limit should be set lower than 14A.

$$I_{LIM} = 1338 \times \left(\frac{R_{ILIM}}{1k}\right)^{-0.95}$$

HT81697 包含一个升压和一个音频功放。其中升压电路将输入的电池电压 VBAT 升压至更高的电压，以提供给功放。该方法可提升功放的输出功率。该升压需要外部放置电感和二极管。

HT81697 内置的升压，在非轻载时，工作在近固定频率的 PWM 调制方式。轻载时，则工作在 PFM 模式。

输出电压 V_{OUT} 可通过 FB 的上下拉电阻 R_{UP} , R_{DN} 调节:

$$V_{OUT} = V_{REF} \times \left(1 + \frac{R_{UP}}{R_{DN}}\right)$$

其中, $V_{REF} = 1.204V$

典型电压设置如下。

为了避免意外的尖峰电流, HT81697 具有逐周期限流功能。当开关电流达到限流值后, 低端管迅速关闭。开关管限流值可通过 ILIM 脚的接地电阻 R_{ILIM} 调节, 如下公式或曲线图。峰值电流限制值设置应小于 14A。

$$I_{LIM} = 1338 \times \left(\frac{R_{ILIM}}{1k}\right)^{-0.95}$$

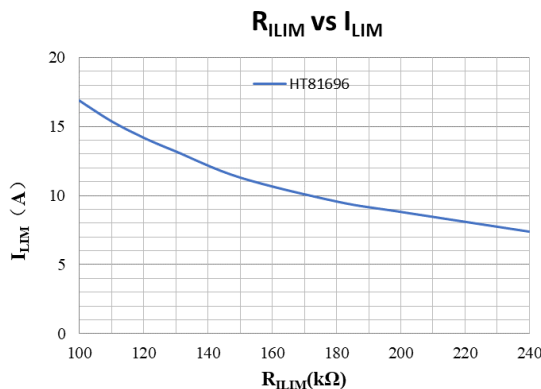

Figure 1 Switch Current Limit Setting

1.3 Enable and Startup (ENB and SS pin)

The 81697 has an adjustable soft start function to prevent high inrush current during start-up. To minimize the inrush current during start-up, an external capacitor, connected to the SS pin and charged with a constant current, is used to slowly ramp up the internal positive input of the error amplifier. The larger the capacitance at the SS pin, the slower the ramp of the output voltage and the longer the soft-start time. A 1uF capacitor is usually sufficient for most applications.

HT81697 integrates two modes with different tr/ff for the boost converter. With a single capacitor (C_{SS}) connected between SS/EMI pin and Ground, the mode with steep tr/ff will be selected, HT81697 operates with a higher efficiency and poorer EMI performance. However, if a capacitor (C_{SS}) paralleled with a resistor 330k (R_{EMI}) is placed between SS/EMI pin and Ground, the mode with flatter tr/ff is selected, HT81697 operates with a lower efficiency and better EMI performance.

When the ENB pin is pulled into logic low (below 0.4V), the boost converter stops switching and goes into bypass mode (the amplifier power is powered directly by input power supply through Schottky diode).

Only when ENB pin is pulled into logic high (above 1.5V), the boost converter works.

1.4 Loop Stability (COMP pin)

The boost converter requires external compensation, which allows the loop response to be optimized for each application. The COMP pin is the output of the internal error amplifier. An external compensation network comprised of resistor R_C, ceramic capacitors C_C and C_P is connected to the COMP pin. To be simplified, R_C is 100kΩ, C_C is 3.3nF, and C_P is 1nF. But notice that this setting can only be adopted in most cases. In detail, the compensation network parameters can be calculated as follows.

HT81697 具有软启动功能，以避免启动过程中的冲击电流。SS 外接电容，可调节软启动时间，电容越大，软启动时间越长。通常情况下，1uF 电容可满足要求。

HT81697 具有两种不同 tr/ff 时间的模式。当 SS/EMI 引脚仅接一个电容(C_{SS})到地时，tr/ff 更陡，此时 HT81697 的效率更高，但 EMI 表现更差；当 SS/EMI 引脚接一个电容(C_{SS})并联 330k 电阻到地时，tr/ff 更缓，此时 HT81697 的效率更低，但 EMI 表现更好。

当 ENB 拉低（小于 0.4V）时，升压关闭，进入直通模式，功放供电由输入电压经肖特基二极管直接供电。

当 ENB 高于 1.5V 时，升压工作。

HT81697 需要外部补偿电路，以使不同应用下环路响应得到优化。补偿电路是 COMP 脚外接的 R_C、C_C 和 C_P。

通常情况下，R_C 100k、C_C 3.3nF、C_P 1nF 可满足应用，但仍可能存在不适用的情况。具体的，补偿电路参数可按照如下步骤设置。

(1) Set the cross over frequency, f_c

The first step is to set the loop crossover frequency, f_c . The higher crossover frequency, the faster the loop response is. It is generally accepted that the loop gain cross over no higher than the lower of either 1/10 of the switching frequency, f_{sw} , or 1/5 of the RHPZ frequency, f_{RHPZ} . It's proper to use a fixed parameter of 10kHz for f_c .

$$f_{RHPZ} = \frac{R_O \times (1 - D)^2}{2\pi \times L}$$

(2) Set the compensation resistor, R_C .

$$R_C = \frac{2\pi \times V_{OUT} \times R_{sense} \times f_c \times C_O}{(1 - D) \times V_{REF} \times G_{EA}}$$

(3) Set the compensation zero capacitor, C_C

$$C_C = \frac{R_O \times C_O}{2 \times R_C}$$

(4) Set the compensation pole capacitor, C_P

$$C_P = \frac{R_{ESR} \times C_O}{R_C}$$

If the C_P is less than 10pF, it can be left open.

- R_O is the output load resistance.
- D is the switching duty cycle. $1 - D = V_{IN} / V_{OUT}$
- R_{sense} is the equivalent internal current sense resistor, which is 0.084 Ω .
- C_O is output capacitor.
- V_{REF} is the reference voltage at the FB pin, which is 1.204V.
- G_{EA} is the amplifier's transconductance, which is 190 μ A/V.
- R_{ESR} is the equivalent series resistance of the output capacitor.

1.5 BOOST Converter Input and Output Capacitor C_{IN} , C_{OUT}

For the capacitor maintaining the supply voltage, the value of the boost capacitor is determined by the minimum value of working capacitance required for stability and the maximum voltage ripple allowed on PVDD in the application. It acts as a charge reservoir, providing energy faster than the board supply, thus helping to prevent any droop in the supply voltage.

For the decoupling capacitor, a low equivalent-series-resistance (ESR) ceramic capacitor is needed. This choice of capacitor and placement helps with higher frequency transients, spikes, or digital hash on the line. Additionally, placing this decoupling capacitor close to the HT81697 is important, as any parasitic resistance or inductance between the device and the capacitor causes efficiency loss.

Over all, 1 μ F//10 μ F//220 μ F (paralleled) is highly recommended to be placed in both input and output terminal as closely to the pin as possible.

(1) 设置交叉频率 f_c

交叉频率越高，环路响应越快。一般其取 1/10 f_{sw} ，或 1/5 f_{RHPZ} ，或固定的 10kHz。

$$f_{RHPZ} = \frac{R_O \times (1 - D)^2}{2\pi \times L}$$

(2) 设置 R_C

$$R_C = \frac{2\pi \times V_{OUT} \times R_{sense} \times f_c \times C_O}{(1 - D) \times V_{REF} \times G_{EA}}$$

(3) 设置 C_C

$$C_C = \frac{R_O \times C_O}{2 \times R_C}$$

(4) 设置 C_P

$$C_P = \frac{R_{ESR} \times C_O}{R_C}$$

如果 C_P 小于 10pF，其可以悬空。

其中：

R_O 是输出等效负载阻值；

D 开关占空比， $1 - D = V_{IN} / V_{OUT}$

R_{sense} 是内部等效感流电阻，为 0.084 Ω

C_O 是输出电容；

V_{REF} 是 FB 电压，为 1.204V；

G_{EA} 是跨导，为 190 μ A/V；

R_{ESR} 是输出电容的等效串联电阻。

对于储能电容，电容值由应用中稳定所需的最小工作电容值和 PVDD 上允许的最大电压纹波决定。较大的储能电容有助于防止电源电压下降。

对于滤波电容器，低等效串联电阻(ESR)的陶瓷电容器较为合适。这种电容的选择和布局有助于提高线路上的瞬态尖峰和噪声。此外，将这种滤波电容靠近 HT81697 非常重要，因为芯片和电容之间的任何寄生电阻或电感都会导致效率损失。

我们建议，在 VBAT 和 PVDD 端至少放置一组 1 μ F 和 10 μ F 滤波电容到地，用于吸收纹波和稳定电压，并尽可能靠近芯片引脚。另外，VBAT 和 PVDD 端需各放置一个不小于 220 μ F 的储能电容。这些电容应以最短的路径连接至安静可靠的地，以有效滤波。

1.6 Inductor Selection and Placement

Because the selection of the inductor affects the power supply's steady state operation, transient behavior, loop stability, and boost converter efficiency, the inductor is the most important component in switching power regulator design. Three most important specifications to the performance of the inductor are the inductor value, DC resistance, and saturation current.

To be simplified, the inductor value can be set as 2.2uH or 4.7uH which can be used in most cases.

The rated current, especially the saturation current should be larger than the peak current during the whole operation. The peak current can be calculated as follows:

$$I_{Lpeak} = I_{DC} + \frac{I_{PP}}{2}$$

$$I_{DC} = \frac{V_{OUT} \times I_{OUT}}{V_{IN} \times \eta}$$

$$I_{PP} = \frac{1}{L \times \left(\frac{1}{V_{OUT} - V_{IN}} + \frac{1}{V_{IN}} \right) \times f_{SW}}$$

Boost converter efficiency is affected significantly by the inductor's DC resistance (DCR), equivalent series resistance (ESR) at the switching frequency, and the core loss. An inductor with lower DCR and ESR would increase the efficiency significantly.

The inductor should be placed as close as possible to the SW pin. For a lower EMI radiation and higher robustness, connecting a resistor Rsw (Typ. 1ohm) and a capacitor Csw (Typ. 3.3nF) in series from SW to the ground, and also a resistor Rsw (Typ. 1ohm) and a capacitor Csw (Typ. 3.3nF) in series from SW to the output voltage terminal (the cathode of Schottky diode) would be helpful.

1.7 Schottky Diode Selection and Placement

Schottky diode with fast recovery times and low forward voltages are recommended. Ensure the diode average and peak current rating exceed the average output current and peak inductor current. In addition, the diode's reverse breakdown voltage must exceed the output voltage.

升压电感的选型，直接影响到系统的运行稳定性。电感选型最重要的三个参数：电感值，DCR，饱和电流。

简单来说，电感值可选择 2.2uH 或 4.7uH，可满足大多数应用条件。

电感的额定电流、特别是饱和电流，必须大于整个运行条件下的最高峰值电流。峰值电流可如下计算：

升压效率受电感的DCR、开关频率下的等效ESR、以及铁损影响较大。使用较低的DCR和ESR的电感，可提高整体效率。

电感应尽可能靠近 SW 脚防止。SW 脚串接一个电阻和电容（典型值 1ohm 和 3.3nF）到地，SW 脚串接一个电阻和电容（典型值 1ohm 和 3.3nF）到升压输出端（肖特基二极管阴极）可有效降低芯片的 EMI 辐射，并提升可靠性。

肖特基二极管应选择快恢复时间和低正向电压。应确保二极管的平均额定电流、峰值额定电流超过输出平均电流和电感峰值电流。此外，二极管的反向击穿电压应大于输出电压。

2 Analog Signal Input Configuration

HT81697 is an amplifier with analog input (single-ended or differential).

For a differential operation, input signals into INP and INN pins via DC-cut capacitors (C_{IN}) and external input resistors R_{EIN} . See as figure 2. The system gain can be calculated by $Gain \approx 20 \times \log\left(\frac{R_F}{R_{IIN} + R_{EIN}}\right)$, where $R_F = 630k$, $R_{IIN} = 10k$. And the high pass cut-off frequency of input signal can be calculated by $f_c = \frac{1}{2\pi(R_{IIN} + R_{EIN}) \times C_{IN}}$.

For a single-ended operation, input signals to INP pin via a DC-cut capacitor (C_{IN}) and external input resistor (R_{EIN}). INN pin should be connected to ground via a DC-cut capacitor and external input resistor (R_{EIN}) (with the same value of C_{IN} and R_{EIN}). See as figure 3. The Gain and high pass Cut-off frequency are the same as the above case.

HT81697 接受模拟差分或单端音频信号输入，产生 PWM 脉冲输出信号驱动扬声器。

对差分输入，通过隔直电容 C_{IN} 和输入电阻 R_{EIN} 分别输入到 INP 和 INN 端，见图 2。系统增益 $Gain \approx 20 \times \log\left(\frac{R_F}{R_{IIN} + R_{EIN}}\right)$ ， $R_F = 630k$ ， $R_{IIN} = 10k$ 。高通滤波器截止频率为 $f_c = \frac{1}{2\pi(R_{IIN} + R_{EIN}) \times C_{IN}}$ 。

对单端输入，则通过 C_{IN} 耦合到 INP 端。INN 端必须通过输入电阻和电容（与 C_{IN} 、 R_{EIN} 值相同）接地，见图 3。增益 Gain 和截止频率 f_c 与差分输入时相同。

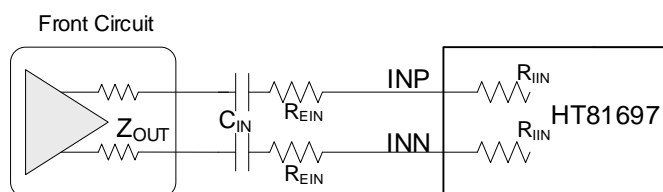

Figure 2 Differential Input configuration

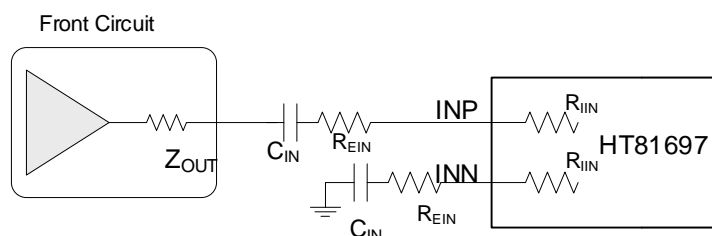

Figure 3 Single-ended Input configuration

3 Output Configuration

HT81697 can directly drive speakers without any other components. But if EMI is highly concerned, ferrite beads or L-C filter is needed.

一般而言，输出端可直接连接负载喇叭。如对 EMI 的要求较高，则可选择添置铁氧体磁珠或 LC 滤波器。

4 Speaker Amplifier Operating Modes

HT81697 can work in different modes by setting the CTRL terminal, shown as follow.

HT81697 在 CTRL 端输入不同电压值，能实现多种工作模式，详见下表。

Table 1 CTRL Terminal Configuration

Mode	CTRL Voltage		
	MIN	TYP	MAX
Spread spectrum off, Class D mode	2.3V	3.3V	5.0V
Spread spectrum on, Class D mode	1.7V	1.8V	1.9V
Class AB mode	0.8V	1.1V	1.4V
SD(Shutdown) Mode	0V	0V	0.5V

4.1 Startup, Shutdown

The HT81697 employs a shutdown mode of operation designed to reduce supply current (I_{DD}) to the absolute minimum level during periods of nonuse for power conservation. The CTRL terminal should be held low to shutdown the device to enter the low-current state.

For a better power on and power-off pop performance, place the amplifier in the shutdown mode prior to delivering or removing the power supply.

HT81697 具有关断功能，以使芯片进入低功耗状态。当 CTRL 拉低时，芯片进入关断状态。

上下电时，为减小 pop 声，在上、下电前，将功放关闭进入关断状态。

4.2 Spread Spectrum

The HT81697 device has built-in spread spectrum control of the oscillator frequency to improve EMI performance. The spread spectrum scheme is internally fixed and by setting the CTRL terminal.

HT81697 器件内置了扩频控制，以提高 EMI 性能。扩频方案内部固定，通过 CTRL 引脚设置开启。

4.3 Class AB

The HT81697 device can work in Class AB mode, which can avoid EMI issue that can be caused in Class D mode.

HT81697 器件可工作在 AB 类模式，可完全避免 EMI 等 D 类的干扰问题。

5 Anti-Clipping Function (ACF terminal)

HT81697 can work in different ACF modes and MUTE mode by setting the ACF terminal, shown as follow.

HT81697 可工作在 ACF 模式，通过设置 \SD 进入。

Table 2 ACF Terminal Configuration

Resistor on ACF pin to GND (R_{ACF})	Working Mode
$< 10k$	MUTE
33k	ACF1
56k	ACF2
100k	ACF3
$>200k$	ACF OFF

In ACF modes, HT81697 attenuates system gain to an appropriate value when an excessive input is applied, so as not to cause the clipping at the differential signal output. In this way, the output audio signal is controlled in order to obtain a maximum output level without distortion. And HT81697 also follows to the clips of the output waveform due to the decrease in the power-supply voltage.

在 ACF 模式下，当电路检测到输入信号幅度过大而产生输出削顶时，HT81697 通过自动调整系统增益，控制输出达到一种最大限度的无削顶失真功率水平，由此大大改善了音质效果。此外，当电源电压下降时，HT81697 也能自动衰减输出增益，实现与 PVDD 下降值相匹配的最大限度无削顶输出水平。

The Attack time of ACF Function is a time interval until system gain falls to target attenuation gain $-3dB$ when a big enough signal input. And, the Release Time is a time from target attenuation gain to not working of ACF. The maximum attenuation gain is $18dB$.

ACF 模式下的启动时间 (Attack time) 指在突然输入足够大信号而产生输出削顶的条件下，ACF 启动对放大器的增益调整速率，以 ms/dB 为单位；释放时间 (Release time) 指产生削顶的输入条件消失，增益退出衰减状态的速率，以 ms/dB 为单位。HT81697 的最大衰减增益为 $18dB$ 。

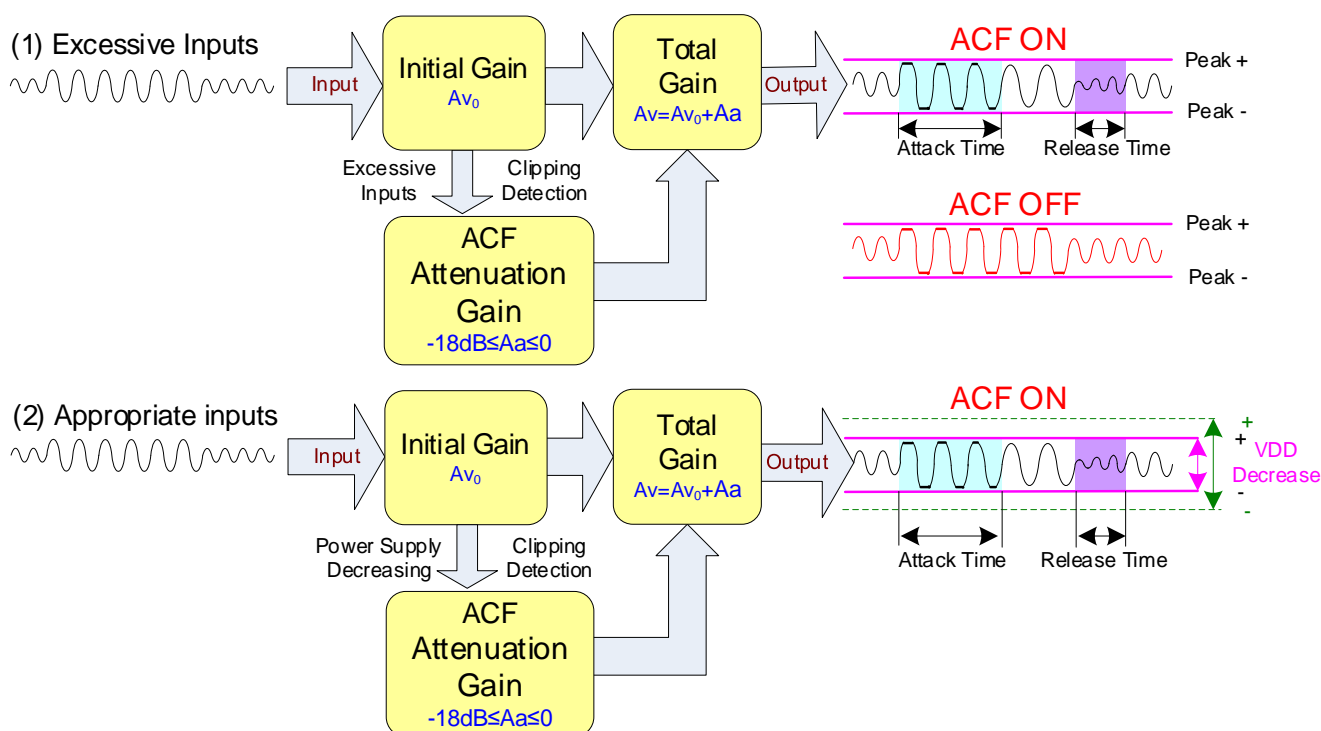

Figure 4 the ACF Function Operation Outline

Table 3 Attack time and Release time

ACF mode	Attack time	Release time
ACF3	45ms	100ms
ACF2	4ms	2.8s
ACF1	45ms	350ms

In MUTE mode, the differential output signal is muted, other internal modules are in normal operation, and the output stage becomes a high impedance state.

For a better pop performance, place the amplifier in MUTE mode prior to shutdown or enable the device.

6 LDOP and LDON

Decouple LDON with a X5R ceramic 1 μ F capacitor to GND, LDOP with 1 μ F capacitor to PVDD.

在静音模式下，输出无声，内部其他模块仍处于工作状态，输出端切换至高阻态。

为减小 pop 声，在 shutdown/使能前，将功放 MUTE。

使用 X5R 陶瓷 1 μ F 电容器将 LDON 与 GND 连接，1 μ F 电容器将 LDOP 与 PVDD 连接。

7 Protection Function

HT81697 has the protection functions such as Over-Current Protection function, Thermal Protection function, and over voltage protection.

(1) Over-current Protection function

When a short circuit occurs between one output terminal and Ground, PVDD, or the other output, the over-current protection mode starts up. In the over current protection mode, the differential output terminal becomes a high impedance state. Once the short circuit conditions are eliminated, the over current protection mode can be cancelled automatically.

(2) Thermal Protection function

When excessive high temperature of HT81697 (150°C) is detected, the thermal protection mode starts up. In the thermal protection mode, the differential output terminal becomes Weak Low state (a state grounded through high impedance).

(3) Over-voltage Protection function

The HT81697 device monitors the voltage on PVDD voltage. When the voltage on PVDD pin exceeds the over-voltage threshold (18V typ), the OVP circuit puts the device into shutdown mode. The device recovers automatically once the over-voltage condition has been removed.

(4) Under-Voltage Protection (UVP)

This is the function to establish the under-voltage protection mode when PVDD power supply becomes lower than the detection voltage V_{UVLL} (Typ 2.65V), and the protection mode is canceled when the power supply becomes higher than the threshold voltage V_{UVLH} (Typ 2.7V). In the under-voltage protection mode, the differential output pin becomes a high impedance state. HT81697 will start up within start-up time when the under-voltage protection mode is cancelled..

HT81697 具有以下几种保护功能：输出端过流保护、片内过温保护、升压过压保护。

(1) 过流保护

当检测到一输出端对电源、对地、或对另一输出端短路时，过流保护启动，输出端切换至高阻态，防止芯片烧毁损坏。短路情况消除后，通过关断、唤醒一次芯片，或重新上电均能使芯片退出保护模式。

(2) 过温保护

当检测到芯片内温度超过 150°C 时，过温保护启动，正负输出端切换至弱低电平状态（内部通过高阻接地），防止芯片被热击穿损坏。

(3) 过压保护

HT81697 监控 PVDD 电压上的电压。当 PVDD 引脚上的电压超过过电压阈值（18V 典型值）时，OVP 电路将 HT81697 置于关机模式。一旦消除过电压情况，设备将自动恢复。

(4) 欠压保护

该功能是在当 PVDD 电源低于检测电压 V_{UVLL} (Typ 2.65V) 时建立欠压保护模式，当电源高于阈值电压 V_{UVLH} (Typ 2.7V) 时取消保护模式。在欠压保护模式下，输出端切换至高阻态。取消欠压保护模式后，HT81697 会在启动时间内启动。

PACKAGE OUTLINE

SPE (ESOP16)

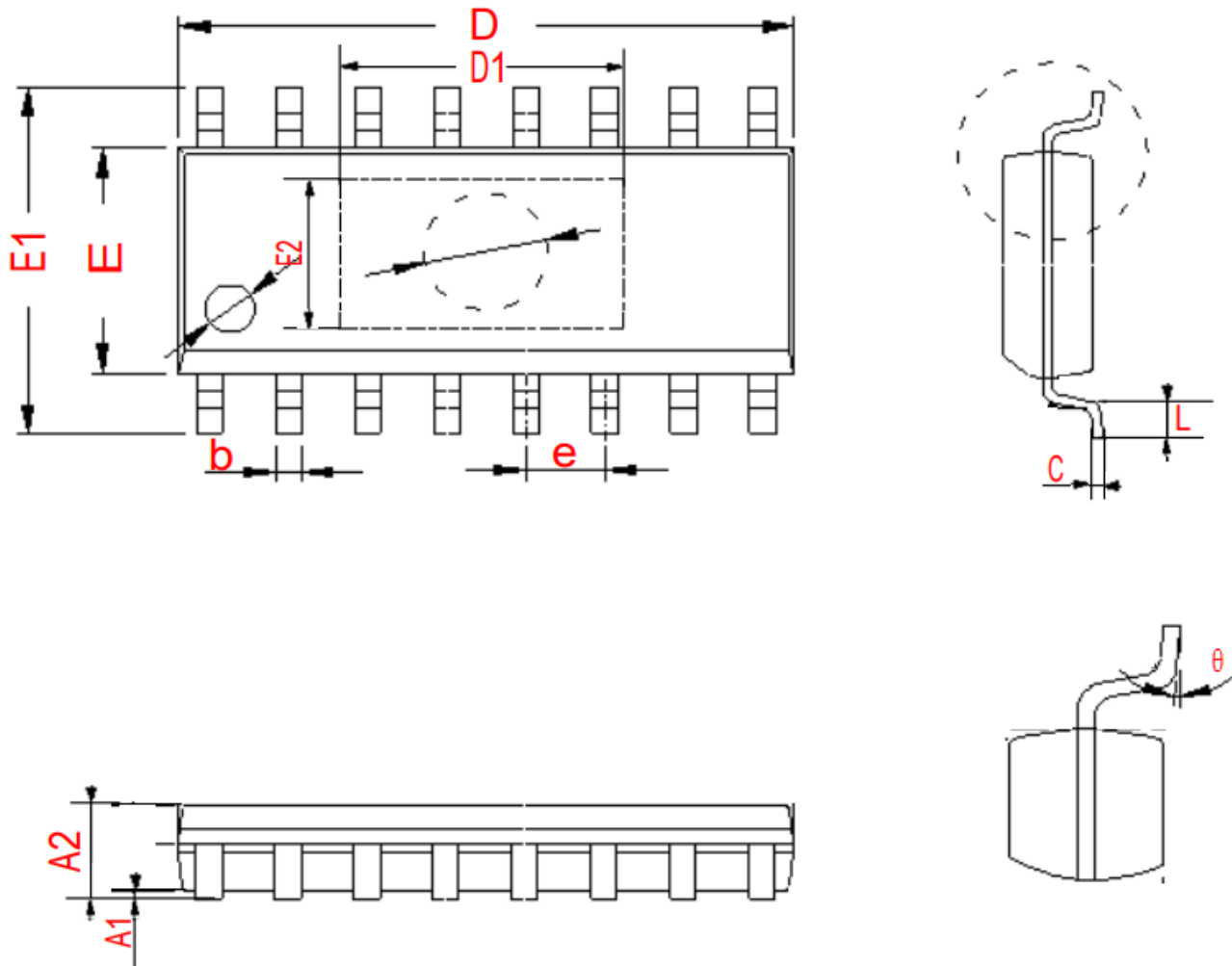

Symbol	Size (mm)	
	MIN	MAX
A1	0.1	0.25
A2	1.25	1.55
b	0.33	0.51
C	0.17	0.25
D	9.8	10.2
D1	4.3	4.6
E	3.8	4.0
E1	5.8	6.2
E2	2.3	2.5
e	1.27(BSC)	
L	0.4	1.27
θ	0°	8°

IMPORTANT NOTICE**注意**

Heroic Electronic Technology (Jiaxing) Co., Ltd (HT) reserves the right to make corrections, modifications, enhancements, improvements, and other changes to its products and services at any time and to discontinue any products or services. Customers should obtain the latest relevant information before placing orders and should verify that such information is current and complete.

禾润电子科技（嘉兴）股份有限公司（以下简称HT）保留对产品、服务、文档的任何修改、更正、提高、改善和其他改变，或停止提供任何产品和服务的权利。客户在下单和生产前应确保所得到的信息是最新、最完整的。

HT assumes no liability for applications assistance or customer product design. Customers are responsible for their products and applications using HT components.

HT对相关应用的说明和协助以及客户产品的板级设计不承担任何责任。

HT products are not authorized for use in safety-critical applications (such as life support devices or systems) where a failure of the HT product would reasonably be expected to affect the safety or effectiveness of that devices or systems.

HT的产品并未授权用于诸如生命维持设备等安全性极高的应用中。

The information included herein is believed to be accurate and reliable. However, HT assumes no responsibility for its use; nor for any infringement of patents or other rights of third parties which may result from its use.

本文中的相关信息是精确和可靠的，但HT并不对其负责，也不对任何可能的专利和第三方权利的侵害负责。

Following are URLs and contacts where you can obtain information or supports on any HT products and application solutions:

下面是可以联系到我公司的相关链接和联系方式：

禾润电子科技（嘉兴）股份有限公司
Heroic Electronic Technology (Jiaxing) Co., Ltd.

地址：浙江省嘉兴市凌公塘路3339号JRC大厦A座三层

Add: A 3rd floor, JRC Building, No. 3339, LingGongTang Road, Jiaxing, Zhejiang Province

Sales: 0573-82585539, sales@heroic.com.cn

Support: 0573-82586151, support@heroic.com.cn

Fax: 0573-82585078

Website: www.heroic.com.cn; wap.heroic.com.cn

Wechat MP: HEROIC_JX

请及时关注禾润官方微信公众号，随时获取最新产品信息和技术资料！

