

THICK FILM CHIP RESISTOR NETWORK HYC/HTC SERIES

Features

- High density packaging provides higher productivity.
- Stable convex terminal reduces assembly costs.
- Compatible with flow and reflow soldering.

Applications

- Computer
- Mobile phone
- Camcorder
- Portable audio
- Battery charger
- Hard Disk Driver

Configuration

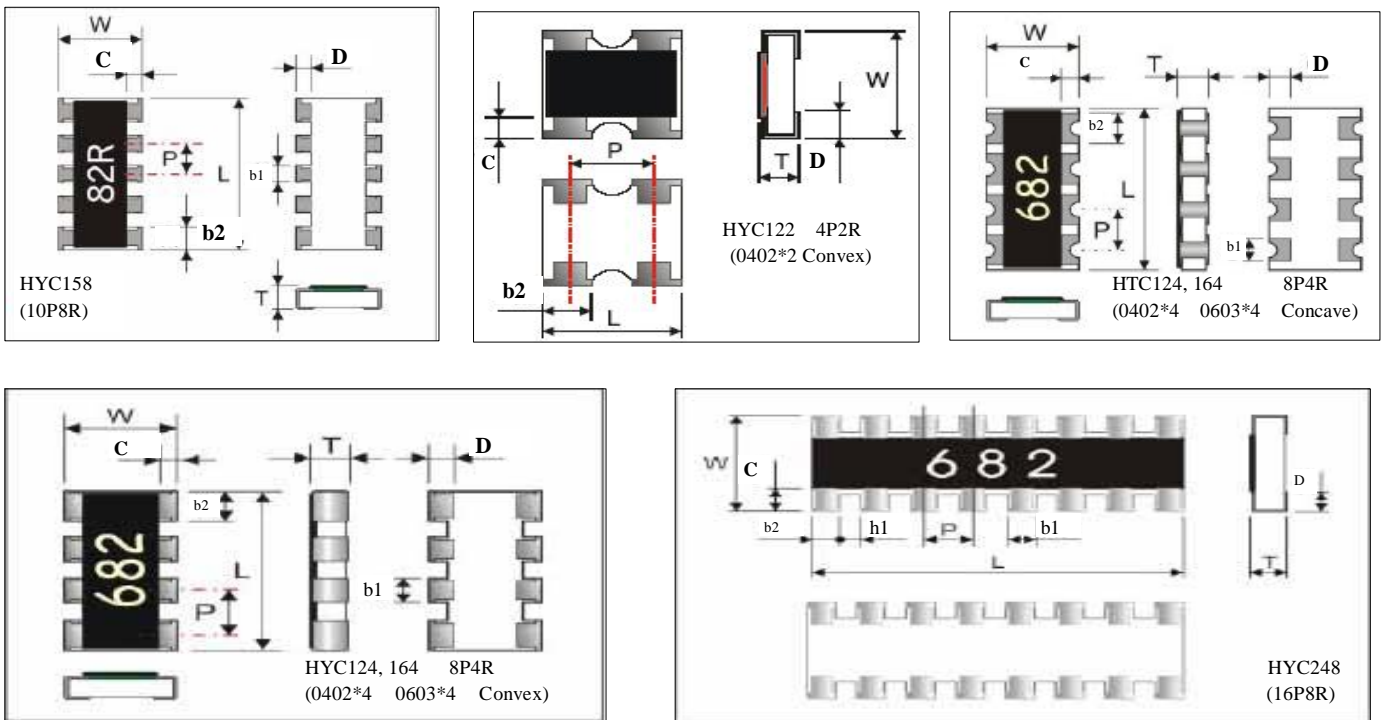

Dimensions

TYPE	L	W	T	C	D	P	b1	b2	h1
HYC122	1.00±0.10	1.00±0.10	0.35±0.10	0.20±0.15	0.25±0.17	0.65±0.10	-	0.34±0.10	-
HYC124	2.00±0.10	1.00±0.10	0.45±0.10	0.20±0.10	0.25±0.10	0.50±0.05	0.30±0.05	0.40±0.10	-
HTC124	2.00±0.10	1.00±0.10	0.45±0.10	0.20±0.15	0.25±0.10	0.50±0.05	0.25±0.05	0.25±0.05	-
HYC164	3.20±0.20	1.60±0.10	0.50±0.10	0.30±0.20	0.30±0.20	0.80±0.10	0.45±0.10	0.60±0.15	-
HTC164	3.20±0.20/-0.10	1.60±0.20/-0.10	0.60±0.10	0.35±0.15	0.50±0.15	0.80±0.10	0.50±0.15	0.60±0.15	-
HYC158	3.30±0.20	1.60±0.15	0.55±0.10	0.40±0.15	0.40±0.15	0.64±0.05	0.40±0.15	0.50±0.05	-
HYC248	4.00±0.20	1.60±0.15	0.45±0.10	0.30±0.25	0.30±0.20	0.50±0.20	0.30±0.10	0.40±0.20	0.20±0.10

unit:mm

THICK FILM CHIP RESISTOR NETWORK HYC/HTC SERIES

Power Derating Curve

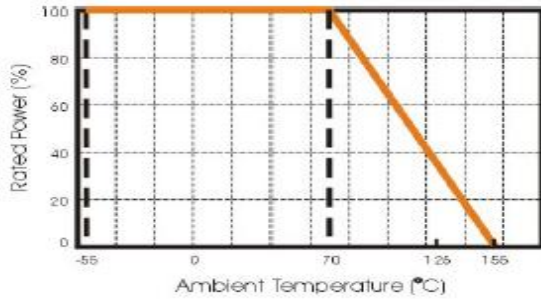

Maximum dissipation in percentage of rated power as a function of the ambient temperature for HYC122 , HYC124 , HTC124 , HYC164 , HTC164 , HYC158

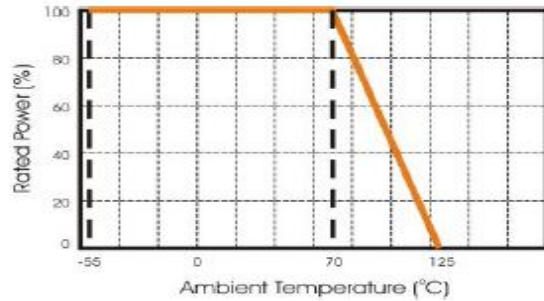

Maximum dissipation in percentage of rated power as a function of the ambient temperature for HCY248

Circuit

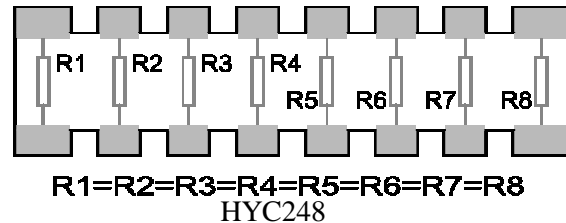
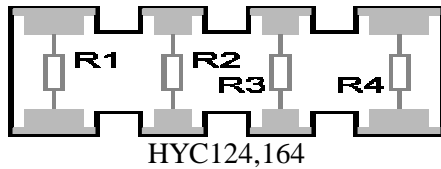
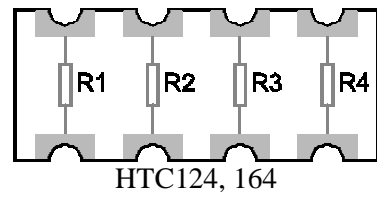
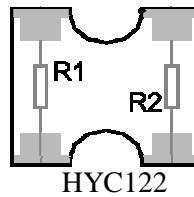
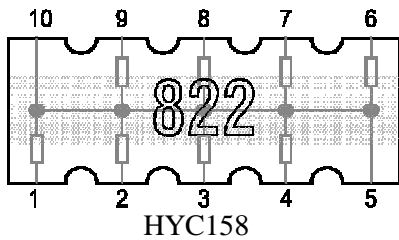

Rating

Type	Size	Termination Construction	Power Rating at 70°C	Max. RCWV	Max. Overload Voltage	Resistance Tolerance (%)	Temperature Coefficient (TCR; ppm/°C)	Resistance Range (Ω)		Standard Resistance Values
								Min.	Max.	
HYC122	4P2R 0402*2	Convex	1/16W	25V	50V	±5%(J)	±300	0Ω,10Ω	1MΩ	E-24
HYC124	8P4R 0402*4	Convex	1/16W	25V	50V	±5%(J) ±1%(F)	±300	0Ω,10Ω 100Ω	1MΩ 1MΩ	E-24
HTC124	8P4R 0402*4	Concave	1/16W	25V	50V	±5%(J) ±1%(F)	±300	0Ω,10Ω 10Ω	1MΩ 1MΩ	E-24
HYC164	8P4R 0603*4	Convex	1/16W	50V	100V	±5%(J) ±1%(F)	±200	0Ω,10Ω	1MΩ	E-24
HTC164	8P4R 0603*4	Concave	1/16W	50V	100V	±5%(J)	±200	0Ω,10Ω	1MΩ	E-24
HYC158	10P8R	Convex	1/16W	25V	50V	±5%(J)	±200	10Ω	100KΩ	E-24
HYC248	16P8R	Convex	1/16W	25V	50V	±5%(J) ±1%(F)	±200	0Ω,10Ω 10Ω	100KΩ 100KΩ	E-24

Jumper : ⊙ 8P4R size maximum resistance $R_{max} < 50m\Omega$ and rated current $I_R \leq 1A$

THICK FILM CHIP RESISTOR NETWORK HYC/HTC SERIES

Soldering Temperature Curve

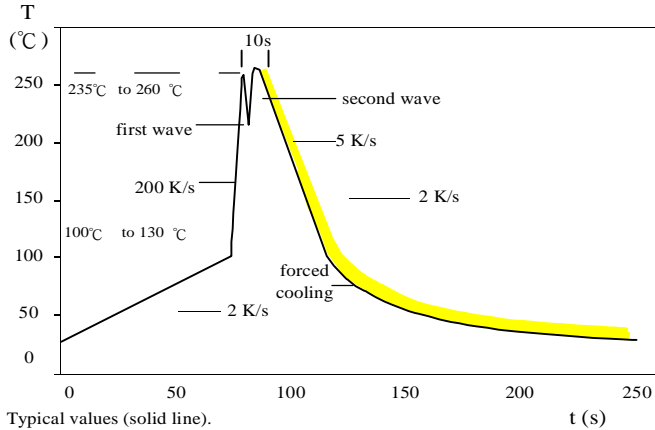

Typical values (solid line).
Process limits (dotted line).
WAVE soldering.

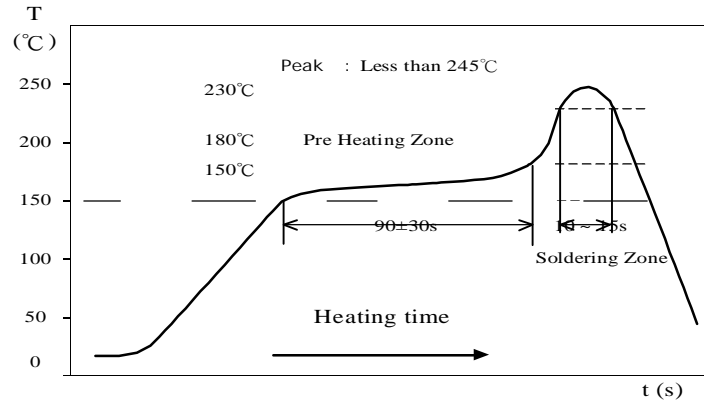

IR Reflow Soldering

Part Number

HYC	164	J	R	4K7R
Type	Size	Tolerance	Packing	Ohmic value
HYC	122 : 0402*2	F : ± 1%	R : Paper tape - 5Kpcs	
	124 : 0402*4(Convex)	J : ± 5%		
HTC	124 : 0402*4(Concave)			
	164 : 0603*4(Concave)			
HYC	164 : 0603*4(Convex)			
	158 : 10P8R			
	248 : 16P8R			

Resistance Marking

- E - 24 SERIES

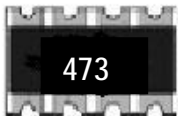

3 digit marking for E24

examples **473** $47 \times 10^3 = 47K$

Standard resistance value

E3	10				22				47			
E6	10		15		22		33		47		68	
E12	10	12	15	18	22	27	33	39	47	56	68	82
E24	10	12	15	18	22	27	33	39	47	56	68	82
	11	13	16	20	24	30	36	43	51	62	75	91

THICK FILM CHIP RESISTOR NETWORK HYC/HTC SERIES

GENERAL SPECIFICATION

■ Tape And Reel Package

Taping specs are according to EIA RS-481

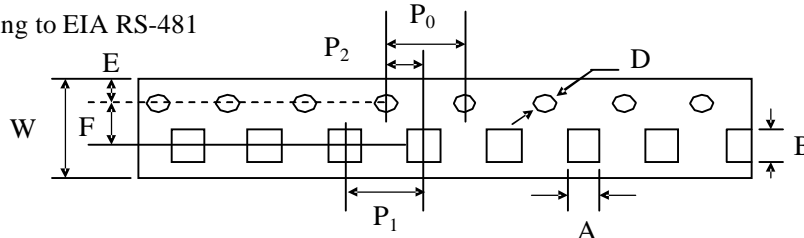

Accumulated dimensional tolerance $40\pm 0.2\text{mm}$

Size	A	B	W	F	E	P1	P2	P0	D
0402*2	1.15 ± 0.10	1.15 ± 0.10	8.00 ± 0.30	3.50 ± 0.20	1.75 ± 0.10	2.00 ± 0.05	2.00 ± 0.05	4.00 ± 0.10	$1.50+0.10/-0$
0402*4 (Convex Concave)	1.20 ± 0.20	2.20 ± 0.20	8.00 ± 0.30	3.50 ± 0.20	1.75 ± 0.10	2.00 ± 0.05	2.00 ± 0.05	4.00 ± 0.10	$1.50+0.10/-0$
0603*2 (Convex)	1.80 ± 0.10	1.80 ± 0.10	8.00 ± 0.30	3.50 ± 0.10	1.75 ± 0.10	4.00 ± 0.10	4.00 ± 0.10	4.00 ± 0.10	$1.50+0.10/-0$
8P4R (Convex Concave)	2.00 ± 0.20	3.60 ± 0.20	8.00 ± 0.30	3.50 ± 0.20	1.75 ± 0.10	4.00 ± 0.10	2.00 ± 0.05	4.00 ± 0.10	$1.50+0.10/-0$
10P8R	$1.85+0.20/-0$	$3.45+0.20/-0$	8.00 ± 0.30	3.50 ± 0.20	1.75 ± 0.10	4.00 ± 0.10	2.00 ± 0.05	4.00 ± 0.10	$1.50+0.10/-0$
16P8R	$1.80+0.20/-0$	$4.20+0.20/-0$	12.00 ± 0.10	5.50 ± 0.05	1.75 ± 0.10	4.00 ± 0.10	2.00 ± 0.05	4.00 ± 0.10	$1.50+0.10/-0$

(unit: mm)

nReel Package

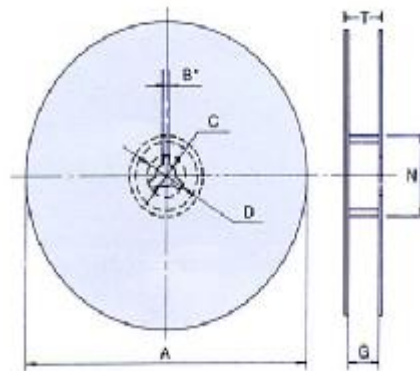

Size	Packaging Q'ty	A	N	C	D	B	G	T
0402*2 0402*4 (Convex , Concave) 0603*2 (Convex) 8P4R (Convex , Concave) 10P8R, 16P8R	5Kpcs / Reel	178.0 ± 2.0	60.0 ± 0.5	13.0 ± 0.5	20min	2.0 ± 0.5	10.0 ± 1.5	14.9 max.
8P4R	10Kpcs / Reel	254.0 ± 2.0	100.0 ± 1.0	13.5 ± 0.5	20min	2.0 ± 0.5	10.0 ± 1.5	14.9 max.
	20Kpcs / Reel	330.0 ± 2.0	100.0 ± 1.0	13.5 ± 0.5	20min	2.0 ± 0.5	10.0 ± 1.5	14.9 max.

(unit: mm)

THICK FILM CHIP RESISTOR NETWORK HYC/HTC SERIES GENERAL SPECIFICATION

■ Specification And Test Methods

ITEM	SPECIFICATION	TEST METHOD
DC Resistance	J: $\pm 5\%$, F: $\pm 1\%$ Zero ohm Jumper $< 50m\Omega$	IEC 60115-1 / JIS C 5201-1 , Clause 4.5 Measure the resistance value.
Short time Overload	J: $\Delta R \leq \pm (2\% + 0.1\Omega)$ F: $\Delta R \leq \pm (1\% + 0.05\Omega)$	IEC 60115-1 / JIS C 5201-1 , Clause 4.13 2.5×Rated voltage or Max. Overload Voltage for 5 sec. measure resistance after 30 minutes
Solderability	Over 95% of termination must be covered with solder	IEC 60115-1 / JIS C 5201-1 , Clause 4.17 After immersing flux, dip in the $235\pm 2^\circ\text{C}$ molten solder bath for 2 ± 0.5 sec.
Resistance to Solder Heat	J: $\Delta R \leq \pm (1\% + 0.1\Omega)$ F: $\Delta R \leq \pm (0.5\% + 0.05\Omega)$ No mechanical damage	IEC 60115-1 / JIS C 5201-1 , Clause 4.18 With $260\pm 5^\circ\text{C}$ for 10 ± 1 sec.
Temperature Coefficient of Resistance(TCR)	Size: 0402*2,0402*4 ± 300 ppm/ $^\circ\text{C}$ Size:0603*2, 0603*4, 10P8R, 16P8R ± 200 ppm/ $^\circ\text{C}$	IEC 60115-1 / JIS C 5201-1 , Clause 4.8 Test temperature : 25°C (T1) \rightarrow -55°C (T2) 25°C (T1) \rightarrow $+155^\circ\text{C}$ (T2) $\text{TCR (ppm}/^\circ\text{C)} = \frac{R2-R1}{R1} \times \frac{1}{T2-T1} \times 10^6$ T1: 25°C T2: Test temperature R1: Resistance at reference temperature (T1) R2: Resistance at test temperature (T2)
Load Life Humidity	J: $\Delta R \leq \pm (3\% + 0.1\Omega)$ F: $\Delta R \leq \pm (1\% + 0.05\Omega)$	IEC 60115-1 / JIS C 5201-1 , Clause 4.24 Maintain the temperature of the resistor at $40\pm 2^\circ\text{C}$ and 90~95% R.H. with the rated voltage applied. Cycle ON for 1.5 hours and OFF for 0.5 hour for 1000+40 hours. After 1~4 hour, measure the resistance value.
Load Life	J: $\Delta R \leq \pm (3\% + 0.1\Omega)$ F: $\Delta R \leq \pm (1\% + 0.05\Omega)$	IEC 60115-1 / JIS C 5201-1 , Clause 4.25 Permanent resistance change after 1000+48/-0 hours (1.5 hours ON , 0.5 hour OFF) at RCWV or Max. Keep the resistor at $70\pm 2^\circ\text{C}$ ambient
Temperature Cycle	J: $\Delta R \leq \pm (1\% + 0.1\Omega)$ F: $\Delta R \leq \pm (0.5\% + 0.05\Omega)$ No mechanical damage	IEC 60115-1 / JIS C 5201-1 , Clause 4.19 Repeat 5 cycles as follows -55°C (30 min.) + 25°C (2~3 min.) $+125^\circ\text{C}$ (30 min.) + 25°C (2~3 min.) for HYC248 -55°C (30 min.) + 25°C (2~3 min.) $+155^\circ\text{C}$ (30 min.) + 25°C (2~3 min.) for HYC122, HYC124, HTC124, HYC164, HTC164, HYC158
Insulation Resistance	Between termination and coating must be over $1000M\Omega$	IEC 60115-1 / JIS C 5201-1 , Clause 4.6 Test voltage: $100\pm 15V$
Bending Strength	J: $\Delta R \leq \pm (1\% + 0.1\Omega)$ F: $\Delta R \leq \pm (0.5\% + 0.05\Omega)$ No mechanical damage	IEC 60115-1 / JIS C 5201-1 , Clause 4.33 Resistance change after bended on the 90mm PCB. Bend: 1mm for HYC248 2mm for HYC122, HYC124, HTC124, HYC164, HTC164, HYC1