



TEMPERATURE AND RELATIVE HUMIDITY SENSOR HTS2010SMD

Based on a unique **capacitive cell for humidity** measurement and a **Negative Temperature Coefficient (NTC)** thermistor for temperature measurement, this dual purpose relative humidity / temperature miniaturized sensor is designed for high volume, **cost sensitive applications with tight space constraints**. It is useful in all applications where **dew point, absolute humidity measurements** or humidity compensation are required.

MAIN FEATURES

- Miniature Surface mount SMD package
- Compatible with automated assembly processes, including wave soldering, water immersion and reflow soldering
- Full interchangeability with no calibration required in standard conditions
- High reliability and long term stability
- Available in tape and reel for automatic pick and place
- Individual marking for compliance to stringent traceability requirements



HUMIDITY SENSOR SPECIFIC FEATURES

- Instantaneous desaturation after long periods in saturation phase
- Patented solid polymer structure
- Suitable for linear voltage or frequency output circuitry
- Fast response time

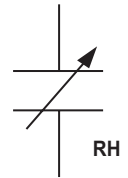

TEMPERATURE SENSOR SPECIFIC FEATURES

- High quality thermistor
- Stable
- High sensitivity



MAXIMUM RATINGS (Ta = 25°C unless otherwise noted)

Ratings	Symbol	Value	Unit
Storage Temperature	Tstg	- 40 to 100	°C
Supply Voltage on humidity cell	Vs	10	Vac
Humidity Operating Range	RH	0 to 100	% RH
Temperature Operating Range	Ta	- 40 to 100	°C
Maximum Electric Power to be supplied (continuous) @ 25°C	P25	2	mW

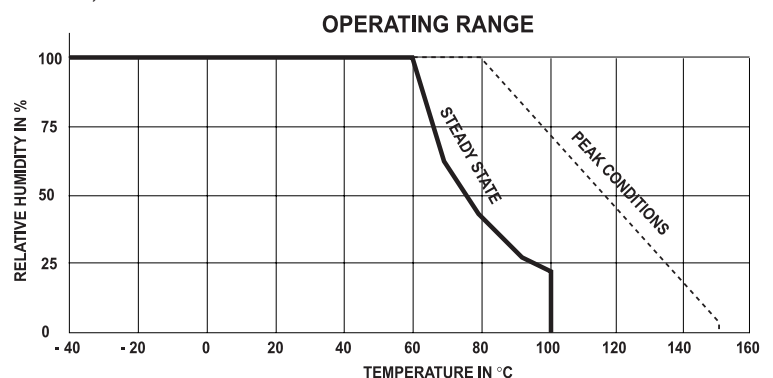

CHARACTERISTICS

Humidity sensor (Ta = 25°C, Vs = 5 volts, measurement frequency @ 10 kHz unless otherwise noted)

Characteristics	Symbol	Min.	Typ.	Max.	Unit.
Humidity measuring range	RH	1		99	%
Nominal capacitance @ 55 % RH*	C	177	180	183	pF
Averaged Sensitivity from 33 % to 75 % RH	$\Delta C/\%RH$		0.34		pF/%RH
Long term stability			0.5		%RH/yr
Recovery time after 150 hours of condensation			10		s
Response time (33 to 76 % RH, static, @ 63 %)	τ		10		

CHARACTERISTICS (CONT)

Humidity sensor (Ta = 25°C, measurement frequency @ 10 kHz unless otherwise noted)

Characteristics	Symbol	Min.	Typ.	Max.	Unit.
Temperature coefficient at 55 % RH / 10 to 40°C	Tcc		+ 0.04		pF/°C
Humidity Hysteresis			+/-1.5		% RH
Deviation to typical curve (see below) (10 % to 90 % RH)			+/-2		% RH
Supply voltage	Vs	1	5	10	Vac
Leakage current (Vs = 5 volts)	I _x			1	nA

*Tighter tolerance available on request

Temperature sensor

Characteristics	Symbol	Min.	Typ.	Max.	Unit.
Nominal resistance @ 25°C			10		kΩ
Beta value : B25/100	B	3600	3730	3800	
Temperature measuring range	Ta	- 40		100	°C
Nominal Resistance Tolerance*	Rn		2	3	%
B value tolerance	B		3		%
Response Time	τ		10		s

*Tighter tolerance available on request

Typical response curve of HTS2010SMD in humidity

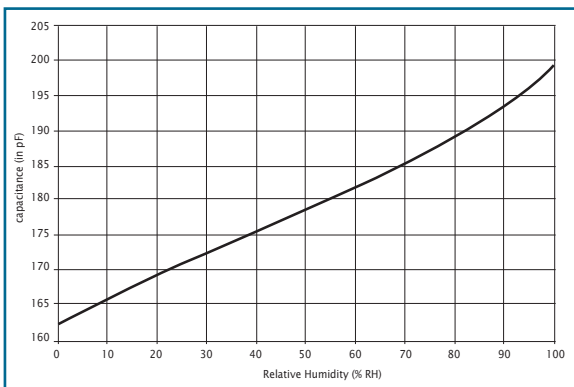

Calibration data are traceable to NIST standards through CETIAT laboratory.

Measurement frequency : 10 kHz
Ta = 25°C

Polynomial response :

$$C = C@55\% * (1.25 \cdot 10^{-7} RH^3 - 1.36 \cdot 10^{-5} RH^2 + 2.19 \cdot 10^{-3} RH + 9.0 \cdot 10^{-1})$$

C in pF, RH in %

Typical temperature output

Depending on the needed temperature measurement range and the associated accuracy, we suggest two methods to access to the NTC resistance values.

$$R_T = R_N - e^{B \left(\frac{1}{T} - \frac{1}{T_N} \right)}$$

R_T NTC resistance in Ω at temperature T in K

R_N NTC resistance in Ω at rated temperature in K

T, T_N Temperature in K

B B value, material-specific constant of the NTC thermistor

e Base of natural logarithm ($e = 2,71828$)

The actual characteristic of an NTC thermistor can, however, only be roughly described by the exponential relation, as the material parameter B in reality also depends on temperature. So this approach is only suitable for describing a restricted range around the rated temperature or resistance with sufficient accuracy.

② For practical applications a more precise description of the real R/T curve may be required. Either more complicated approaches (e.g the Steinhart-Hart equation) are used or the resistance/temperature relation as given in tabulated form. These standardized curves have been experimentally determined with utmost accuracy ; they are also available for temperature increments of 1 degree.

R NTC standardized				R NTC exponential			
°C	ohm	°C	ohm	°C	ohm	°C	ohm
-40	262960	35	6734	-40		35	6670
-35	194110	40	5575	-35		40	5500
-30	144790	45	4636	-30		45	4550
-25	109030	50	3874	-25		50	3800
-20	82923	55	3237	-20		55	3180
-15	63591	60	2720	-15		60	2690
-10	49204	65	2304	-10	52000	65	2270
-5	38279	70	1960	-5	40500	70	1940
0	30029	75	1674	0	31000	75	1650
5	23773	80	1432	5	24500	80	1430
10	18959	85	1235	10	19300	85	1230
15	15207	90	1067	15	15400	90	1070
20	12280	95	927	20	12350	95	925
25	10000	100	809	25	10000	100	810
30	8178			30			

SUGGESTED EVALUATION CIRCUIT FOR HUMIDITY FREQUENCY AND TEMPERATURE ANALOG OUTPUTS

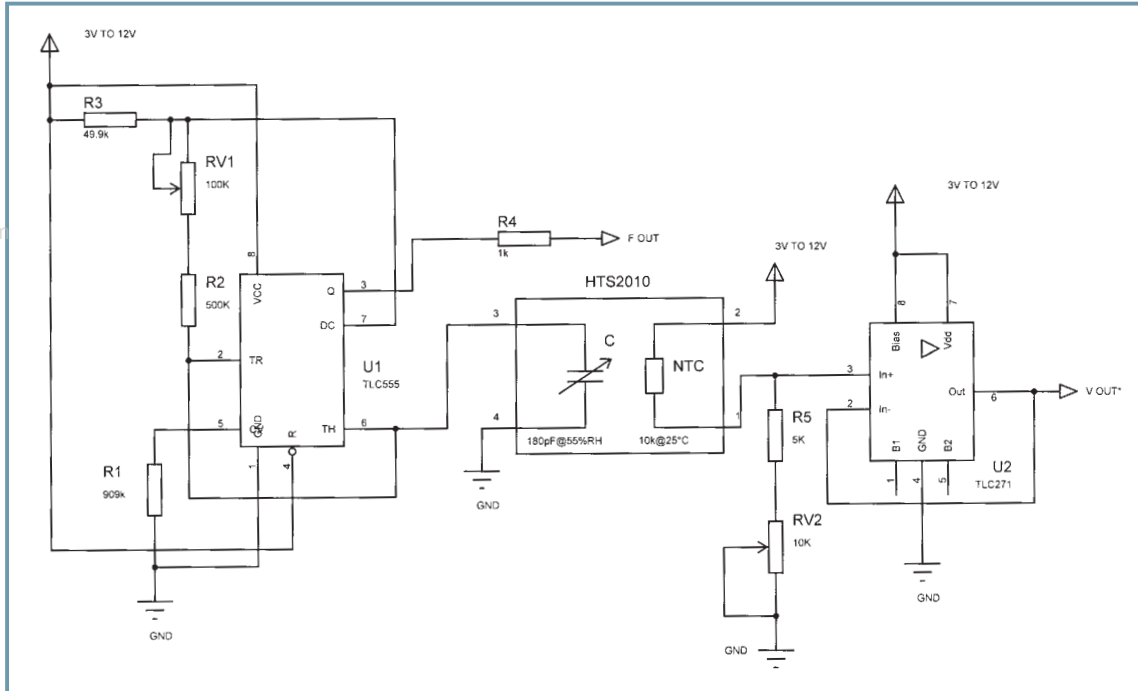

Relative humidity (Frequency output)

This circuit is a typical Astable design for 555. The HTS2010 is used as a variable capacitor and provides an output frequency modulation with relative humidity ranging from 0% to 100%.

In this frequency output circuit configuration (for capacitance measurement), R1 unbalances the internal temperature compensation scheme of the 555. It shifts the negative initial temperature coefficient of the 555 to a positive one that matches the humidity sensing chip's temperature coefficient of $-1.4\text{Hz}/^\circ\text{C}$. In all cases, R1 should be a 1% resistor with a maximum of 100ppm temperature coefficient like all other R-C timer resistors.

Resistors values

Since 555 internal temperature compensation changes from manufacturer to manufacturer, R1 and R2 values should be adapted to device to be used.

555	R1	R2
TLC555 (Texas)	909k Ω	576k Ω
TS555 (STM)	100nF capacitor	523k Ω
7555 (Harris)	1732k Ω	549k Ω
LMC555 (National)	1238k Ω	562k

For a frequency of 6660Hz at 55%RH

Temperature (voltage output)

The temperature measurement is done by a voltage divider, RV2 must be adjusted to get 2.5 V at 25°C as temperature measurement.

Polarization

In order to get better reproducibility during measurement, always connect pin 4 (see the package outline on page 4) to the ground of the circuit.

Soldering instructions

See application note HPC 034 VO

● QUALIFICATION PROCESS

HTS2010SMD sensors have been qualified through a complete qualification process taking in account many of the requirements of the MIL STD750 including :

- Solder heat and solderability
- Wave soldering at 260°C + DI water clean at 45°C
- Mechanical shock - 1500 g, 5 blows, 3 directions
- Vibration - Variable (F = 100 - 2000Hz), fixed (F = 35Hz)
- Constant acceleration
- Marking permanency
- ESD - Electrostatic Discharge - Human body & Machine model
- Salt Atmosphere MIL STD750/Method 1041/96 hours
- Temperature Cycling – -40°C / +70°C
- High Temperature / Humidity Operating Life - 93% RH / 60°C for 1000 hours
- Low humidity storage life - RH < 10%/23°C - 1000 hours
- Resistance to immersion in water at ambient temperature and 80°C - 160 hours
- Resistance to acid vapors at 75000 ppm for nitric, sulfuric and chlorhydric acids
- Resistance to many chemicals linked with home appliances / automotive or consumer applications.

● ENVIRONMENTAL AND RECYCLING INFORMATION :

- HTS2010SMD sensors are lead free components
- HTS2010SMD sensors are free of Cr (VI), Cd and Hg.

● PACKAGE OUTLINE HTS2010SMD GULL WING (LEAD option also available).

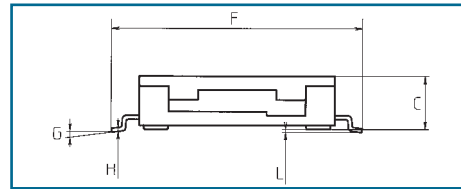
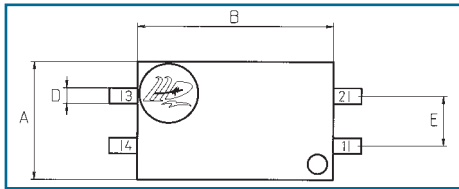

● RECOMMENDED FOOTPRINT

All dimensions in mm
Scale 1:1

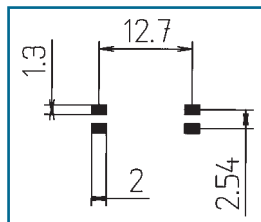

Dimension	A	B	C	D	E	F	G	H	L
mm (typical)	6	10	2.7	0.8	2.54	12.8	0-7°	0.2	0.1

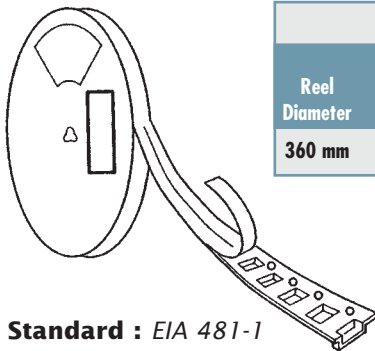

Standard : EIA 481-1
CEI 60286-3

	A	B	C
Reel Diameter			
Reel Width			
Carrier Tape			
Carrier Tape Pitch			
Carrier Tape Depth			
	360 mm	30.4 mm	24 mm
		4 mm	4 mm

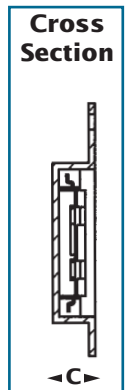
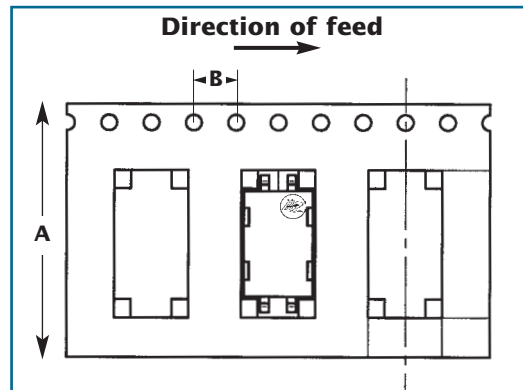

ORDERING INFORMATION OF HTS2010 SMD :

- HPP804B100 (TUBE M.P.Q. OF 80 PIECES).
- HPP804B101 (TAPE AND REEL M.P.Q. OF 1500 PIECES).

TEMPERATURE AND RELATIVE HUMIDITY SENSORS.

SAMPLE KIT OF HTS2010 SMD IS AVAILABLE THROUGH HUMIREL WEB SITE

www.humirel.com

email : sales@humirel.com

The information in this sheet has been carefully reviewed and is believed to be accurate ; however, no responsibility is assumed for inaccuracies. Furthermore, this information does not convey to the purchaser of semiconductor devices any license under the patent rights to the manufacturer. Humirel reserves the right to make changes without further notice to any product herein. Humirel makes no warranty, representation or guarantee regarding the suitability of its product for any particular purpose, nor does Humirel assume any liability arising out of the application or use of any product or circuit and specifically disclaims any and all liability, including without limitation consequential or incidental damages. "Typical" parameters can and do vary in different applications. Customer's technical experts must validate all operating parameters, including "Typical" for each customer application. Humirel does not convey any license under its patent rights nor the rights of others. Humirel products are not designed, intended, or authorized for use as components in systems intended for surgical implant into the body, or other application intended to support or sustain life, or for any application in which the failure of the Humirel product could create a situation where personal injury or death may occur. Should buyer purchase or use Humirel products for any such unintended or unauthorized application, Buyer shall indemnify and hold Humirel and its officers, employees, subsidiaries, affiliates and distributors harmless against all claims, costs, damages and expenses, and reasonable attorney fees arising out of, directly or indirectly, any claim of personal injury or death associated with such unintended or unauthorized use, even if such claim alleges that Humirel was negligent regarding the design or manufacture of the part. Humirel is a registered trademark of Humirel.