

High-reliability hybrid integrated DC/DC converter (HTW28 series)

1. Features (see Fig. 1 for outside view, and Table 1 for models)

Range of input DC voltage: 18~36V, nominal input DC voltage 28V

Output power: 45W

Operating temperature (T_c): -55~+105

Input, output and case are isolated mutually

Insulation resistance: $R \geq 100M\Omega$ (DC 500V)

With the function of inhibit and short-circuit protection

Power density: 28W/in³

Function of pins: same as that of like products of Interpoint Company

Totally sealed metal case



Size: style S: 68.54 × 65.50 × 15.00 mm³
 Style W: 49.33 × 34.30 × 12.70mm³(without fixed end)
 68.80 × 34.30 × 12.70mm³(with fixed end)
 Weight style S: 135g
 Style W: 54g (without fixed end)
 59g (with fixed end)

Table 1 Product models

Single-output	dual-output
HTW28S5F	HTW28D15N(F)
HDW28S5(F)	HTW28D1015F
HTW28S8F(F)	HTW28D15(F)
HTW28S12F	(HDC28D15/1000)
HTW28S18F	HTW28D12(F)
HTW28S12-A	(HDC28D12/1250)
HTW28S15F	triple-output
HTW28S15(F)-A	HTW27T1512(F)
HTS28S24	

Fig.1 Outside view of HTW28 series

2. Scope of application

High-reliability electronic system for aviation and aerospace, etc.

3. Description

HTW28 series high-reliability DC/DC converter can work at 28V input voltage, and the output power is 45W. The case of this series is of totally sealed metal structure with fixed end or without fixed end.

HTW28 series products adopt push-pull structure, both the design and manufacture of HSG28 series products satisfy the requirements of GJB2438A-2002 "General specifications for hybrid integration circuit". Test method and procedure of electric circuit shall execute GJB548A-96 "Test method and procedure for Microelectronic devices".

4. Electrical performance (Table 2~5)

Table 2 Rated conditions and recommended operating conditions

Absolute max. rated value	Input voltage: 18~38V
	Power dissipation: 10W
	Lead wire welding-resistant temperature: 300 °C(10s)
	Storage temperature range: -55~125
Recommended operating conditions	TTL level V_{IL} : 0.2V
	Range of input DC voltage: 18~36V

5 Circuit block diagram (Fig.2~5)

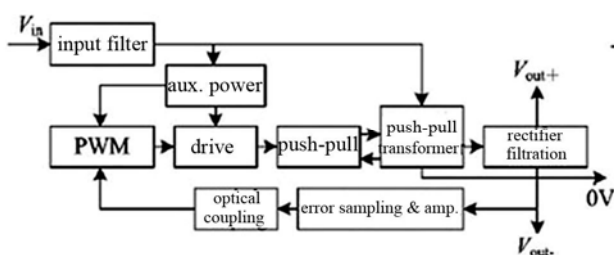

Fig. 2 Circuit block diagram for single-output DC/DC converter

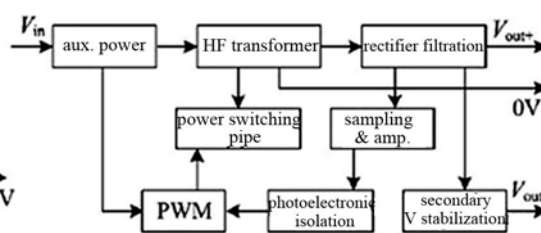

Fig. 2 Circuit block diagram for dual-output unbalanced DC/DC converter

Table 3 Electrical characteristics (single-output)

Parameter	Conditions (unless otherwise specified) $V_{in} = 28V \pm 5\%$ $-55^{\circ}C \leq T_C \leq +105^{\circ}C$	HTW28S5F		HDW28S5(F)		HTW28S8(F)		HTW28S12F		HTW28S12F-A	
		enterprise		military		standard					
		Q/HW30567 -2004	Q/HW30583 -2004	Q/HW30803 -2005	Q/HW20155 -96	Q/HW30811 -2006					
		min.	max.	min.	max.	min.	max.	min.	max.	min.	max.
input voltage/V	$T_A = 25^{\circ}C$	18	36	10	36	22	36	18	36	20	36
output voltage/V	$T_A = 25^{\circ}C$	4.9	5.1	4.9	5.1	7.9	8.1	11.8	12.2	11.85	12.15
output power/W	$T_A = 25^{\circ}C$	—	30	—	22	—	30	—	24	—	24
output current/A	$T_A = 25^{\circ}C$	—	6	—	4.5	—	3.75	0	2.2	—	2.00
output ripple voltage/mV	$T_A = 25^{\circ}C$, full load, 100MHz	—	30	—	40	—	60	—	50	—	50
efficiency/%	$T_A = 25^{\circ}C$, full load	78	—	72	—	80	—	80	—	80	—
load regulation rate/%	$T_A = 25^{\circ}C$, no load to full load	—	1	—	1	—	1	—	0.5	—	0.5
voltage regulation rate/%	$T_A = 25^{\circ}C$, full load	—	0.5	—	0.5	—	0.5	—	0.5	—	0.3
insulating resistance/M Ω	$T_A = 25^{\circ}C$, apply 500V DC voltage between any two of input, output and case	100	—	100	—	100	—	100	—	100	—
inhibition function	—	YES	—	YES	—	—	YES	YES	—	—	YES
protection function	—	YES	—	YES	—	YES	—	YES	—	YES	—
capacitive load/ μ F	—	—	—	—	—	—	—	—	—	—	2 600

Table 3 (continued)

Parameter	Conditions (unless otherwise specified) $V_{in} = 28V \pm 5\%$ $-55^{\circ}C \leq T_C \leq +105^{\circ}C$	HTS28S24		HTW28S15F		HTW28S15(F)-A		HTW28S18F	
		enterprise		military		standard			
		Q/HW20283-2000	Q/HW30657-2004	Q/HW30694-2005	Q/HW30023-99				
		min.	max.	min.	max.	min.	max.	min.	max.
input voltage/V	$T_A = 25^{\circ}C$	18	36	18	36	22	36	18	36
output voltage/V	$T_A = 25^{\circ}C$	23.64	24.36	14.85	15.15	14.85	15.15	17.7	18.3
output power/W	$T_A = 25^{\circ}C$	—	30	—	30	—	45	—	21.6
output current/A	$T_A = 25^{\circ}C$	0	1.2	0	2	—	3.0	0	1.2
output ripple voltage/mV	$T_A = 25^{\circ}C$, full load, 100MHz	—	80	—	70	—	50	—	80
efficiency/%	$T_A = 25^{\circ}C$, full load	82	—	80	—	80	—	80	—
load regulation rate/%	$T_A = 25^{\circ}C$, no load to full load	—	1.0	—	1.0	—	0.5	—	0.5
voltage regulation rate/%	$T_A = 25^{\circ}C$, full load	—	0.5	—	0.5	—	0.2	—	0.5
insulating resistance/M Ω	$T_A = 25^{\circ}C$, apply 500V DC voltage between any two of input, output and case	100	—	100	—	100	—	100	—
inhibition function	—	YES	—	YES	—	—	YES	YES	—
protection function	—	YES	—	YES	—	YES	—	YES	—

Table 4 Electric characteristics (dual-output)

Parameter	Conditions (unless otherwise specified) $V_{in} = 28V \pm 5\%$ $-55^{\circ}C \leq T_A \leq +85^{\circ}C$	HTW28D15N		HTW28D15(F) (HDC28D15/1000)		HTW28D1015F		HTW28D12(F) (HDC28D12/1250)	
		Enterprise military standard: Q/HW20305-2001		Enterprise military standard: Q/HW20036-94		Enterprise military standard: Q/HW30816-2006		Enterprise military standard: Q/HW30790-2005	
		min.	max.	min.	max.	min.	max.	min.	max.
input voltage /V	$T_A = 25^{\circ}C$	20	35	22	36	20	32	22	32
output voltage /V	$T_A = 25^{\circ}C$	14.7	15.4	14.5	15.5	9.7	10.3	11.85	12.15
		-15.4	-14.7	-15.5	-14.5	14.5	15.3	-12.15	-11.85
output power /W	$T_A = 25^{\circ}C$	—	30	—	30	—	30	—	30
output current /A	$T_A = 25^{\circ}C$	0	—	-0.6	1.4	-1.0	1.0	2.5	1250
		—	—	—	—	—	—	0.3	-1250
output ripple voltage /mV	$T_A = 25^{\circ}C$, full load, 100MHz	—	80	—	70	—	—	50	70
efficiency /%	$T_A = 25^{\circ}C$, full load	80	—	80	—	78	—	80	—
load regulation /%	$T_A = 25^{\circ}C$, no load to full load	—	1.5	—	75mV	—	1.5	—	75mV
voltage regulation /%	$T_A = 25^{\circ}C$, full load	—	1	—	50mV	—	1	—	50mV
insulation resistance /M Ω	$T_A = 25^{\circ}C$, apply 500VDC between any two of input, output and case	100	—	100	—	100	—	100	—
inhibit function	—	—	yes	—	yes	—	yes	yes	yes
protection function	—	—	yes	—	yes	—	yes	yes	yes

Table 5 Electric characteristics (triple-output)

Parameter	Conditions (unless otherwise specified) $V_{in} = 18V \pm 1V$ $-55^{\circ}C \leq T_A \leq +85^{\circ}C$	HTW27T1512	
		Enterprise military standard: Q/HW20302-2001	
		min.	max.
input voltage /V	$T_A = 25^{\circ}C$	23	31
		14.64	15.42
output voltage /V	$T_A = 25^{\circ}C$	-15.42	-14.64
		11.69	12.36
output power /W	$T_A = 25^{\circ}C$	30	—
output current /A	$T_A = 25^{\circ}C$	0.8	—
		1	—
output ripple voltage /mV	$T_A = 25^{\circ}C$, full load, 100MHz	—	100
efficiency /%	$T_A = 25^{\circ}C$, full load	70	—
		—	0.6
load regulation /%	$T_A = 25^{\circ}C$, no load to full load	—	0.6
		—	1
voltage regulation /%	$T_A = 25^{\circ}C$, full load	—	0.5
insulation resistance /M Ω	$T_A = 25^{\circ}C$, apply 500VDC between any two of input, output and case	10	—

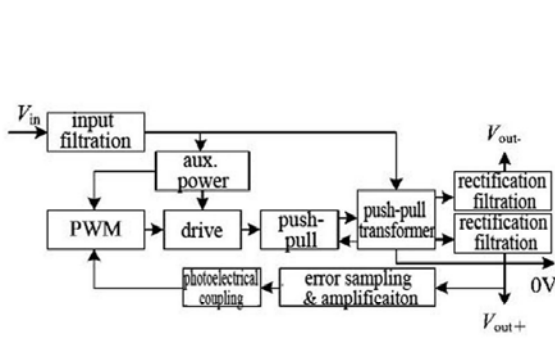

Fig. 4 Circuit block diagram for dual-output DC/DC converter

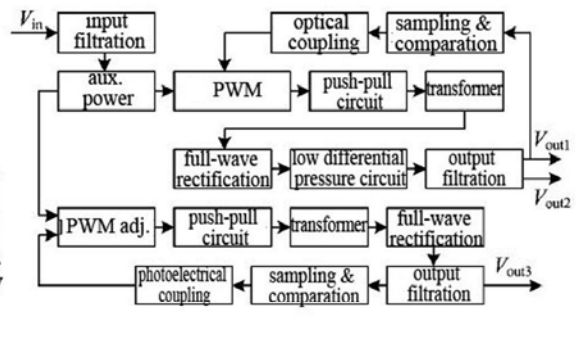

Fig. 5 Circuit block diagram for triple-output DC/DC converter

6 MTBF curve (Fig.6~8)

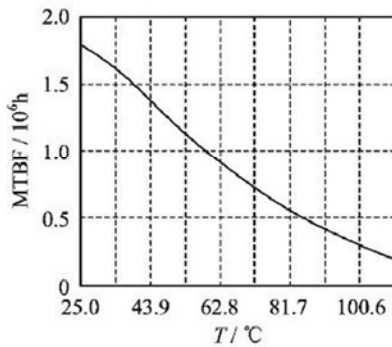

Fig.6 HTW28S15F

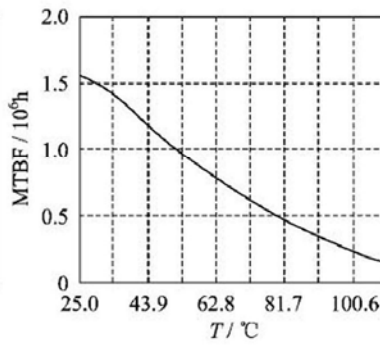

Fig.7 HTW28D1015F

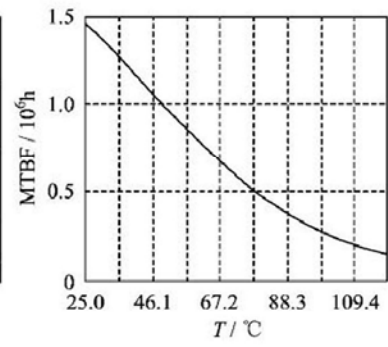

Fig.8 HTW27T1512

(as per GJB/Z299B-98, envisaged good ground condition)

7 Pin designation (Fig.9~11, Table 6~7)

Bottom view

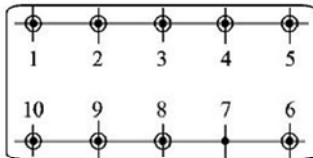

Fig. 9 Style W(without fixed end)

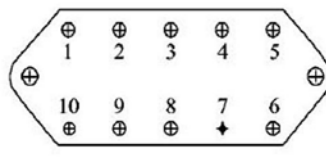

Fig. 10 Style W(with fixed end)

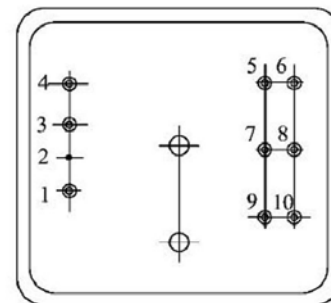

Fig. 11 Style S

Table 6 Pin designation

Function	pin number					
	HTS28S24	HTW28S5F HDW28S5(F)	HTW28S8(F)	HTW28S12F	HTW28S15F	HTW28S12-A HTW28S15(F)-A
input positive	1	1	1	1	1	1
input ground	3	10	10	10	10	10
positive output	5,6	5	5	5	5	5
output ground	7,8	4	4	4	4	4
adjustment*	—	3	3	3	—	3
inhibit	4	2	2	2	2	2
case ground	2	7	7	7	7	7
no connection	9,10	6,8,9	6,8,9	6,8,9	3,6,8,9	6,8,9

Note: *the adjustment pinout adjusts the change of output voltage through external resistance connected between adjustment pin and output (positive or ground).

Table 7 Pin designation

Function	pin number				
	HTW28S18F	HTW28D15N	HTW28D15(F) (HDC28D15/1000)	HTW27T1512	HTW28D1015F
input positive	1	1	1	1	1
input ground	10	10	10	10	10
positive output	5	3	5	5,8	3(10V),5(15V)
negative output	—	5	3	3	—
output ground	4	4	4	4,9	4
inhibit	2	2	2	—	2
case ground	7	6,7,8	7	7	6,7,8
no connection	3,6,8,9	9	6,8,9	2,6	9

8 Connection diagram for typical application (Fig.12~17)

(1) Connection diagram for operation

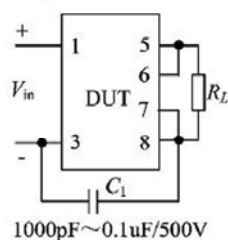

Fig.12 HTS28S24

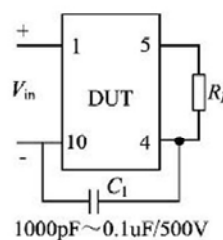

Fig.13 HTW28S5F, HTW28S12F, HTW28S15F
HTW28S18F, HDW28S5(F)

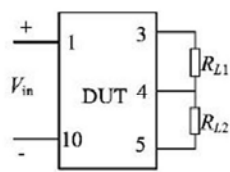

Fig.14 HTW28D15F (HDC28D15/
1000), HTW28D1015F

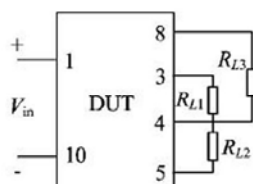

Fig.15 HTW27T1512

(2) Connection diagram for inhibit

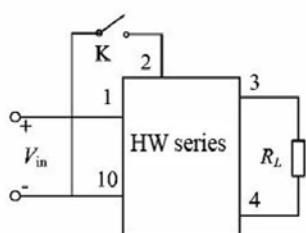

Fig. 16 Connection diagram for inhibit

(3) Connection diagram for EMI filter

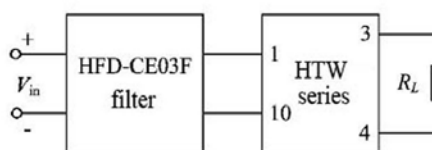

Fig.17 Connection diagram for EMI filter

9 Package specifications (unit: mm) (Fig.18~20, Table 8)

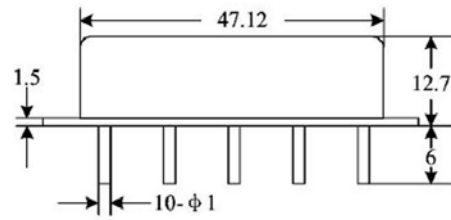
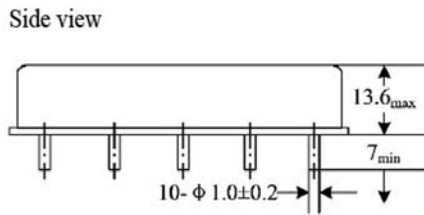
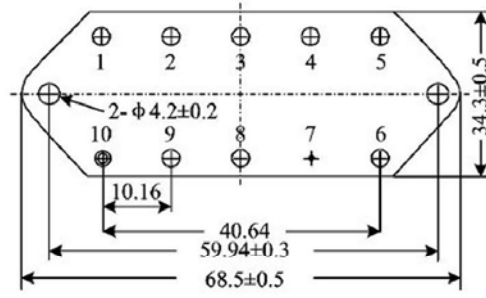
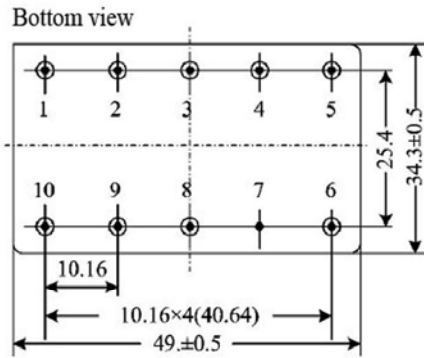

Fig. 18 Style W(without fixed end)

Fig. 19 Style W-F(with fixed end)

(Note: for HTW28D15(F), A=13.6_{max};
for HTW28D15N, HTW28D1015F, A=10.0)

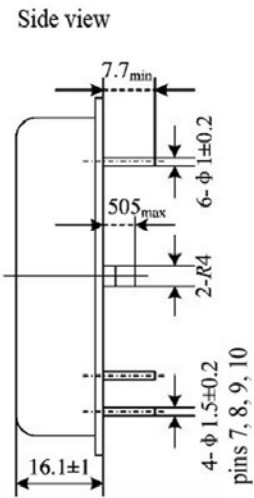
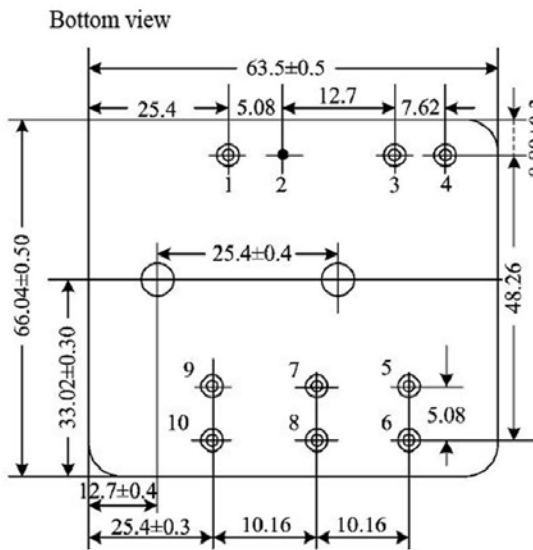

Fig. 20 Style S

10 Part numbering key (Fig. 21)

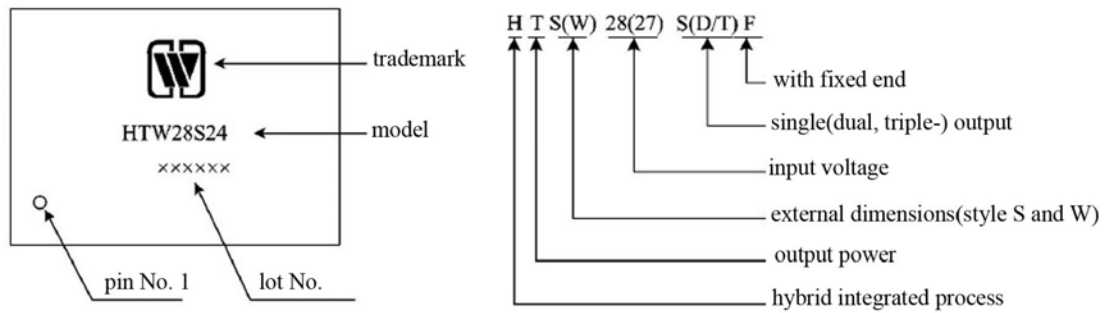

Fig. 21 Part numbering key

Application notes:

- ★ Upon power-on, be sure to correctly connect the positive and negative pole of the power supply to ensure correct power supply for fear of burning.
- ★ When carrying out the electrical performance test, the test position shall be the pinouts of the product.
- ★ Upon assembly, the bottom of the product shall fit to the circuit board closely so as to avoid damage of pins, and shockproof provision shall be added, if necessary.
- ★ Do not bend the pinouts to prevent the insulator from breaking, which affects the sealing property.
- ★ When the case temperature is 105 °C, it is suggested that the thickness of heat sinking plate (copper) shall be 3mm, and the area shall be greater than 80mm × 70mm.
- ★ When the user places an order for the product, detailed electric performance indexes shall refer to the relevant enterprise standard.