

DESCRIPTION

With high isolation, low loss, and low distortion characteristics, this Microsemi Power PIN diode is perfect for the high power switching applications where size and power handling capability are critical.

Its advantages also include the low forward bias resistance and high zero bias impedance that are essential for low loss, high isolation and wide bandwidth performance.

Hermetically sealed, SOGO passivated PIN chips with full-faced metallurgical bonds on both sides to achieve high reliability and high surge capability.

IMPORTANT: For the most current data, consult *MICROSEMI*'s website: <http://www.microsemi.com>

KEY FEATURES

- High Power Stud Mount Package.
- High Zero Bias Impedance
- Very Low Inductance and Capacitance.
- No Internal Lead Straps.
- Small Mechanical Outline.

APPLICATIONS/BENEFITS

- MRI Applications.
- High Power Antenna Switching.

VOLTAGE RATING [25°C]

Reverse Voltage (V_R) – Volts $I_R = 10\mu A$	Part type
100V	HUM2001
500V	HUM2005
1000V	HUM2010
1500V	HUM2015
2000V	HUM2020



Style “D”
Insulated Stud



Style “C”
Stud



Style “B”
Round Axial Leads



Style “SM”
Melf

**Maximum Ratings @ 25°C
(UNLESS OTHERWISE SPECIFIED)**

Parameter	Symbol	TYPE					Unit
		HUM2001	HUM2005	HUM2010	HUM2015	HUM2020	
Maximum Reverse Voltage	T_{RWM}	100	500	1000	1500	2000	V
Average Power Dissipation @ Stud =50°C	I_O	13	13	13	13	13	W
Non-Repetitive Sinusoidal Surge Current (8.3 ms)	I	100	100	100	100	100	A
Storage Temperature Range	T_{STG}	-65 to +175	-65 to +175	-65 to +175	-65 to +175	-65 to +175	°C
Operating Temperature Range	T_{STG}	-55 to +150	-55 to +150	-55 to +150	-55 to +150	-55 to +150	°C
Thermal resistance Junction-to Case “C” Stud only	$R_{\theta JC}$	7.5	7.5	7.5	7.5	7.5	°C/W



HUM2001/HUM2020 SERIES

Pin Diode High Power Stud
PRODUCT PREVIEW/PRELIMINARY

ELECTRICAL PARAMETERS @ 25°C (unless otherwise specified)

Parameter	Symbol	Conditions	Min	Typ.	Max	Units
Diode Resistance	R_S	$F = 4 \text{ MHz}, I_f = 0.5 \text{ A}$		0.10	0.20	Ω
Capacitance C_T	C_T	$F = 1 \text{ MHz}, 100 \text{ V}$		3.4	4.0	pF
Reverse Current	I_R	$V_R @ \text{Rated Voltage}$			10	μA
Carrier Lifetime	τ	$I_f = 10 \text{ mA}/100 \text{ V}$	10	30		μs
Parallel Resistance	R_P	$F = 10 \text{ MHz}, 100 \text{ V}$	200			$\text{k}\Omega$
Forward Voltage	V_f	$I_f = 0.5 \text{ A}$		0.85	1.0	V

HUM2010, 15, 20
TYPICAL



HUM2010, 15, 20
TYPICAL

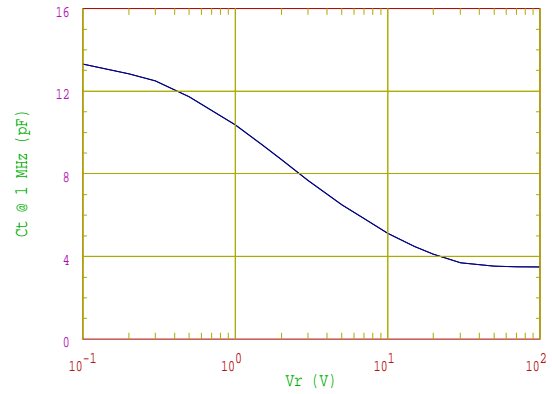

HUM2010, 15, 20
TYPICAL

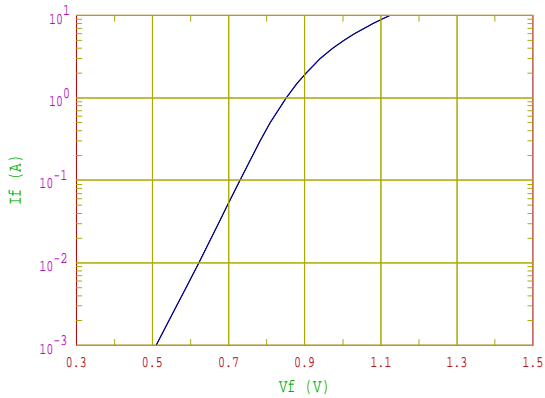

HUM2010, 15, 20
TYPICAL

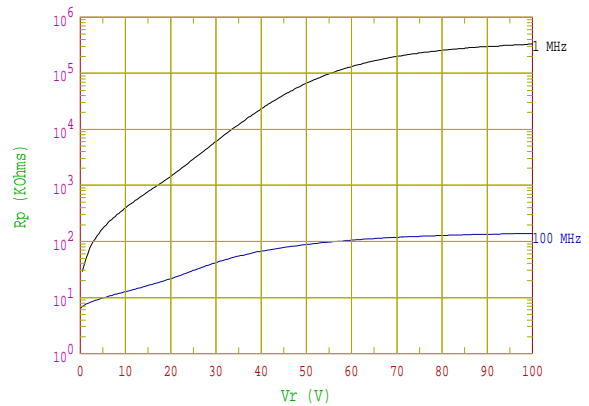

ELECTRICALS

www.Microsemi.com

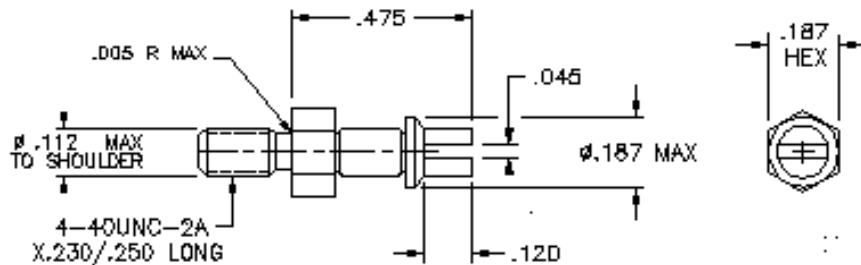
STYLE "C" STUD

NOTES:

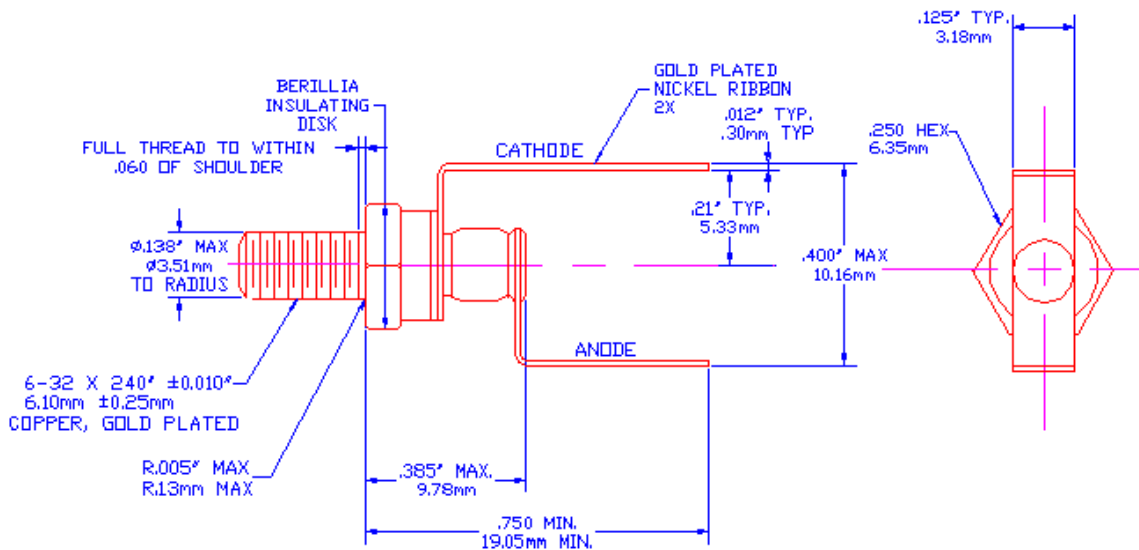
1. CATHODE-TO-STUD IS THE STANDARD PART; REVERSE POLARITY IS DENOTED BY THE SUFFIX "R".
2. METAL PARTS ARE GOLD PLATED PER MIL-G-45204, TYPE II.
3. INSTALLATION PRECAUTIONS INCLUDE:
UN-LUBRICATED STUD TORQUE = 28 INCH DUNCES MAXIMUM.
DO NOT USE A SCREWDRIIVER IN THE TURRET SLOT FOR ANY INSTALLATION PURPOSE * OR DAMAGE MAY RESULT*.
4. DIMENSIONS ARE IN INCHES.

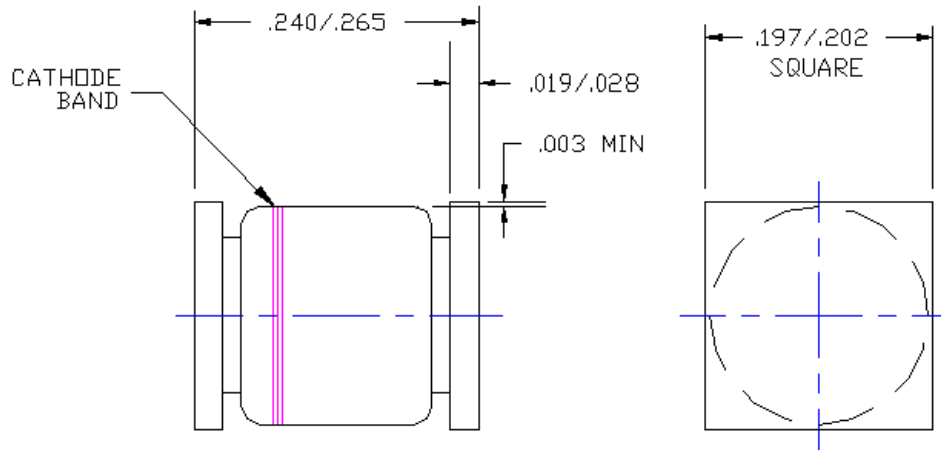
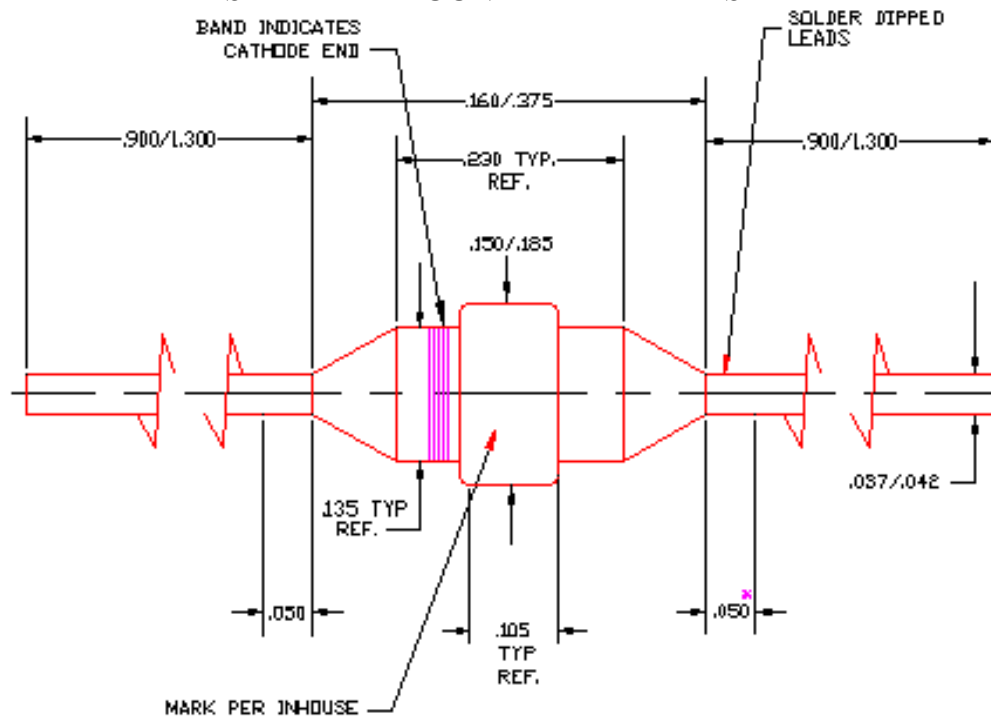
STYLE "D" INSULATED STUD

STYLE "SM" MELF**STYLE "B" ROUND AXIAL LEADS**

Note: Add Style Letter to Suffix of Part Number to Define Device Configuration,
Example: (i.e. HUM2001 C)



HUM2001/HUM2020 SERIES

Pin Diode High Power Stud
PRODUCT PREVIEW/PRELIMINARY