

Quad High Voltage Amplifier Array

Features

- Four Independent High Voltage Amplifiers
- 219V Output Voltage Swing
- 11 V/ μ s Output Slew Rate
- 410 μ A Maximum Operating Current for High Voltage Supply
- Wide Operating Close Loop Gain Range: 50 to 100V/V
- 150 kHz, -3 dB Bandwidth with 15 pF Load
- AEC-Q100 Qualified
- TSSOP and TFBGA Packages

Application

- Tunable Laser
- Micro-Electromechanical Systems (MEMS) Driver
- Test Equipment
- Piezoelectric Transducer Driver

Package Types

General Description

The HV56264 is an AEC-Q100 rated, Quad High Voltage Amplifier Array integrated circuit. The device operates on a 225V high voltage supply and a 5.0V low voltage supply. Amplifiers input voltage range from 0V to 3.3V and output swing ranges from 1.0V to VPP – 6V with a 3 mA sink/source current capability.

The HV56264 is designed for maximum performance with minimal high voltage current. The high voltage current for each amplifier is typically less than 75 μ A.

Related Devices

HV264

Packages

- TSSOP 24L
- TFBGA 60-Ball

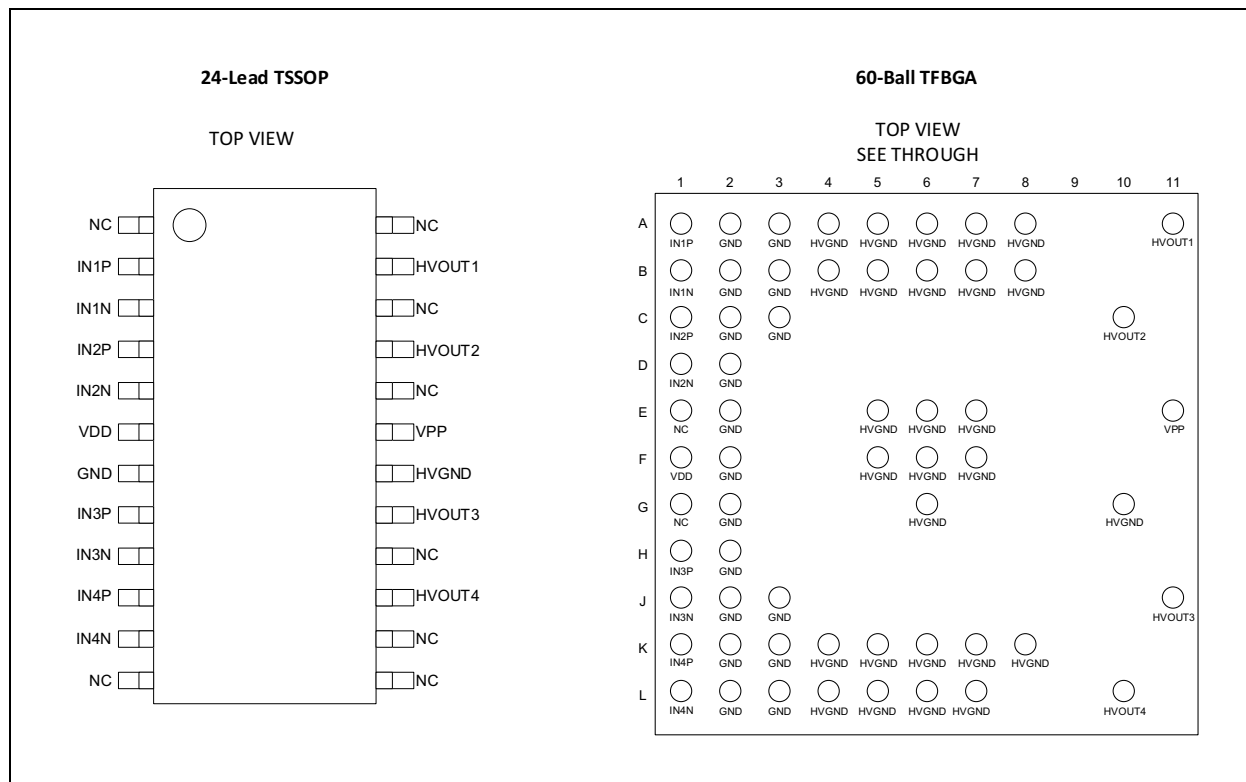

HV56264

Block Diagram

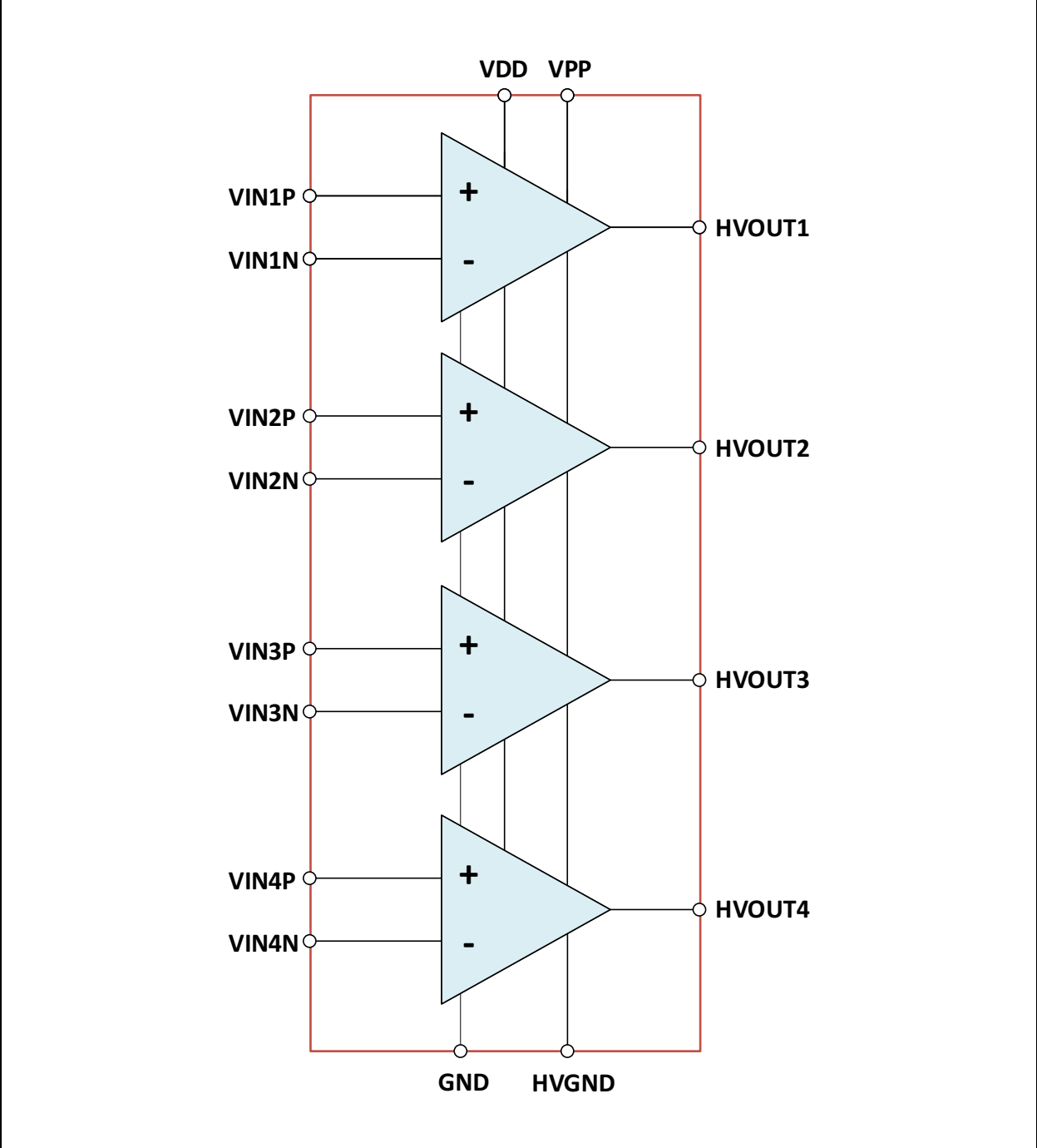

1.0 ELECTRICAL CHARACTERISTICS

Absolute Maximum Ratings †

VIN _{XP,N} High Voltage Amplifiers Inputs.....	-0.3V to 5.5V
V _{DD} Low Output Voltage Supply.....	-0.3V to 5.5V
V _{PP} High Voltage Supply for Op-Amps.....	-0.5V to 250V
Storage Temperature.....	-55°C to +150°C
Operating Junction Temperature.....	-40°C to +125°C
ESD Rating HBM High Voltage Pins.....	1kV
ESD Rating HBM Low Voltage Pins.....	2kV
ESD Rating CDM Corner Pins.....	750V
ESD Rating CDM all Other Pins.....	500V

† **Notice:** Stresses above those listed under “Maximum Ratings” may cause permanent damage to the device. This is a stress rating only and functional operation of the device at those or any other conditions above those indicated in the operational sections of this specification is not intended. Exposure to maximum rating conditions for extended periods may affect device reliability.

TABLE 1-1: RECOMMENDED OPERATING RATINGS

Parameters	Sym.	Min.	Typ.	Max.	Units	Conditions
High Voltage Supply	V _{PP}	50	—	225	V	
Low Voltage Supply	V _{DD}	4.5	5	5.5	V	
Inputs for Amplifiers	VIN _{XP,N}	0	—	3.3	V	

POWER SEQUENCE

Power-Up Sequence

1. Connect Ground
2. Apply VDD
3. Set all inputs to ground
4. Apply VPP

Power-Down Sequence

Reverse order of Power-Up Sequence

HV56264

DC ELECTRICAL CHARACTERISTICS

Electrical Specifications: Unless otherwise specified, $V_{DD} = 5.0V$, $V_{PP} = 225V$, $T_A = T_J = +25^\circ C$. Boldface specifications apply over the full operating temperature range of $T_A = T_J = -40^\circ C$ to $125^\circ C$.						
Parameters	Sym.	Min.	Typ.	Max.	Units	Conditions
V_{PP} Supply Current	I_{PP}	—	—	300	μA	All inputs at 0V, RF = 5.36 M Ω R1 = 79.6 k Ω VDD = 5.5V
		—	—	410		
V_{DD} Supply Current	I_{DD}	—	—	6.6	mA	All inputs at 0V, RF = 5.36 M Ω R1 = 79.6 k Ω VDD = 5.5V
		—	—	8.3		
HV _{OUT} VOH1 Voltage Swing	VOH1	VPP-3	—	—	V	VIN = 3.3V RF = 536 k Ω R1 = 7.97 k Ω (Note 1)
HV _{OUT} VOH2 Voltage Swing	VOH2	VPP-6	—	—		VIN = 3.3V RF = 5.36 M Ω R1 = 79.6 k Ω
HV _{OUT} VOL1 Voltage Swing	VOL1	—	—	1		VIN = 0V RF = 536 k Ω R1 = 7.97 k Ω (Note 1)
HV _{OUT} VOL2 Voltage Swing	VOL2	—	—	1.7		VIN = 0V RF = 5.36 M Ω R1 = 79.6 k Ω
Input Voltage Range	$V_{INXP,N}$	0		VDD-1.5	V	Note 2
Input Current into $V_{INXP,N}$ pins	I_{IN}	—	—	50	nA	VIN = 1V (Note 1)
High Voltage Output Offset Voltage	HV _{OS}	-1.9	—	1.9	V	

Note 1: Specification is obtained by characterization and is not 100% tested.

2: Design guidance only.

AC ELECTRICAL CHARACTERISTICS

Electrical Specifications: Unless otherwise specified, $V_{DD} = 5.0V$, $V_{PP} = 225V$, $T_A = T_J = +25^\circ C$, RF = 5.36 M Ω , R1 = 79.6 k Ω Boldface specifications apply over the full operating temperature range of $T_A = T_J = -40^\circ C$ to $125^\circ C$.						
Parameters	Sym.	Min.	Typ.	Max.	Units	Conditions
HV _{OUT} Slew Rate-Rising Edge	SR	4	11	20	$V/\mu s$	Load = 15 pF 10%-90% VIN = 0 to 3.3V Square Wave
HV _{OUT} Slew Rate-Falling Edge		4	11	20		
Total External Feedback Resistance	FB	700k	—	7M	Ω	External Resistor Network RFB= RF+R1 (Note 2)
Bandwidth (-3dB)	BW	150	—	—	kHz	Load = 15pF VIN= 1.5V DC + 150 mV AC (Note 1)

Note 1: Specification is obtained by characterization and is not 100% tested.

2: Design guidance only.

3: Excluding package parasitic capacitance.

AC ELECTRICAL CHARACTERISTICS (CONTINUED)

Electrical Specifications: Unless otherwise specified, $V_{DD} = 5.0V$, $V_{PP} = 225V$, $T_A = T_J = +25^\circ C$, $R_F = 5.36 M\Omega$, $R_1 = 79.6 k\Omega$						
Boldface specifications apply over the full operating temperature range of $T_A = T_J = -40^\circ C$ to $125^\circ C$.						
Parameters	Sym.	Min.	Typ.	Max.	Units	Conditions
Closed Loop Gain Range	A_V	50	—	100	V/V	External Resistor Network (Note 2)
HV _{OUT} Capacitive Load	C_{LOAD}	0	—	15	pF	(Note 2) (Note 3)
Output Referred Noise	V_N	—	—	10	mV _{rms}	Measured at HV _{OUT} , $V_{IN} = 0.2V$ (Note 1)
VDD Power Supply Rejection Ratio	PSRR1	40	—	—	dB	$V_{DD} = 4.5V$ to $5.5V$ $V_{PP} = 225V$, $V_{IN} = 0.1V$, DC Measurement (Note 1)
VPP Power Supply Rejection Ratio	PSRR2	60	—	—	dB	$V_{DD} = 5V$ $V_{PP} = 50$ to $225V$, $V_{IN} = 0.1V$ DC Measurement (Note 1)
Crosstalk	Xtalk	—	—	-80	dB	Output Referred. $V_{IN} 0$ to $3.3V$ sine wave at 100 Hz with $C_L = 15 pF$ (Note 1)

Note 1: Specification is obtained by characterization and is not 100% tested.

2: Design guidance only.

3: Excluding package parasitic capacitance.

HV56264

TEMPERATURE SPECIFICATIONS

Electrical Specifications: Unless otherwise specified, $V_{DD} = 5.0V$, $V_{PP} = 225V$						
Parameters	Sym.	Min.	Typ.	Max.	Units	Conditions
Temperature Ranges						
Operating Junction Temperature	T_J	-40	—	125	°C	
Storage Temperature	T_S	-55	—	150	°C	
Package Thermal Resistances						
Thermal Resistance - TSSOP	θ_{JC}	—	11.8	—	°C/W	Note 1
	θ_{JA}	—	55	—	°C/W	
Thermal Resistance - TFBGA	θ_{JC}	—	12.4	—	°C/W	
	θ_{JA}	—	47	—	°C/W	

Note 1: 4 Layers FR4 4"X4" PCB

2.0 TYPICAL PERFORMANCE CURVES

Note: The graphs and tables provided following this note are a statistical summary based on a limited number of samples and are provided for informational purposes only. The performance characteristics listed herein are not tested or guaranteed. In some graphs or tables, the data presented may be outside the specified operating range (e.g., outside specified power supply range) and therefore outside the warranted range.

Note: Unless otherwise indicated: VDD = 5.0V, VPP = 225V, VIN = 0V, RF = 5.36 MΩ, RI = 79.6 kΩ, CLOAD = 15 pF.

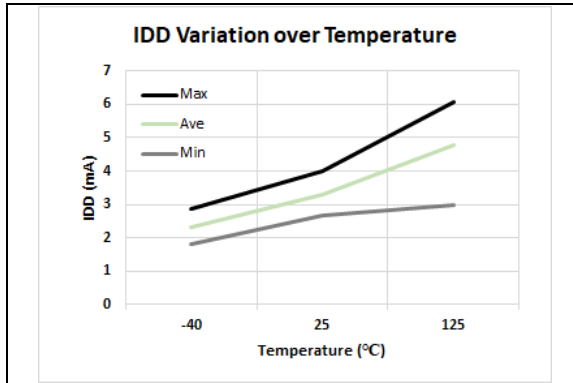

FIGURE 2-1: I_{DD} Variation Over Temperature.

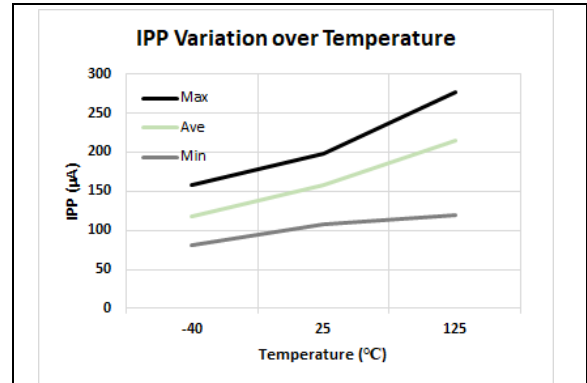

FIGURE 2-4: I_{PP} Variation Over Temperature.

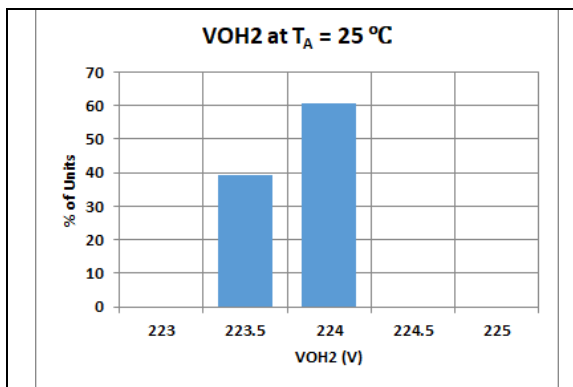

FIGURE 2-2: VO_{H2} Distribution at $T_A = 25^\circ\text{C}$.

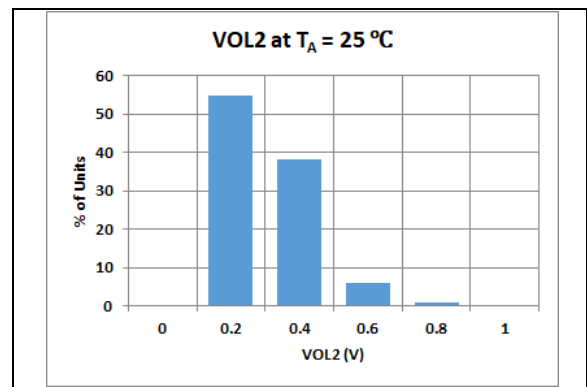

FIGURE 2-5: VOL_2 Distribution at $T_A = 25^\circ\text{C}$.

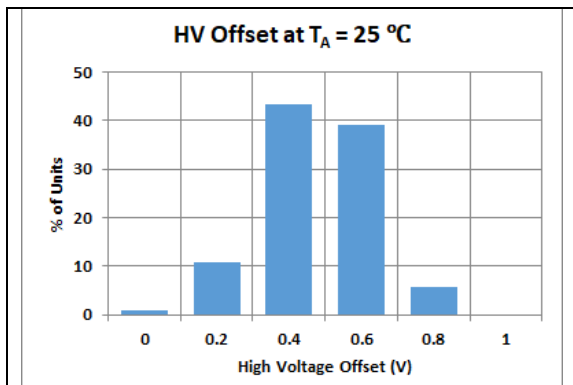

FIGURE 2-3: HV_{OS} Distribution at $T_A = 25^\circ\text{C}$.

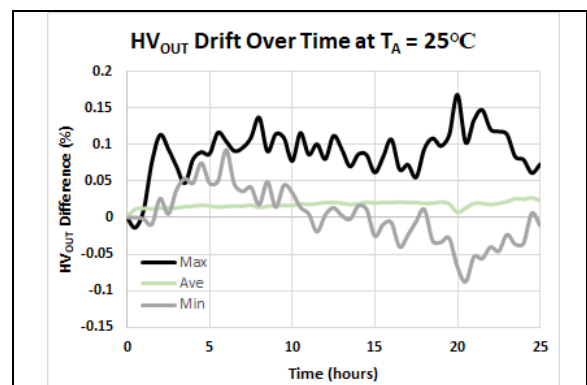

FIGURE 2-6: HV_{OUT} Drift Over Time at $T_A = 25^\circ\text{C}$ ($V_{IN} = 0.2\text{V}$).

HV56264

Note: The graphs and tables provided following this note are a statistical summary based on a limited number of samples and are provided for informational purposes only. The performance characteristics listed herein are not tested or guaranteed. In some graphs or tables, the data presented may be outside the specified operating range (e.g., outside specified power supply range) and therefore outside the warranted range.

Note: Unless otherwise indicated: VDD = 5.0V, VPP = 225V, VIN = 0V, RF = 5.36 MΩ, RI = 79.6 kΩ, CLOAD = 15 pF.

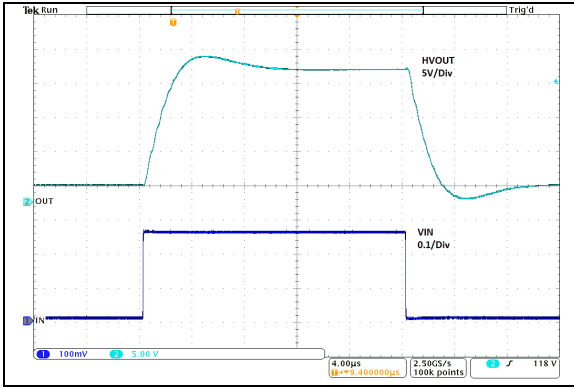

FIGURE 2-7: Typical Small Signal Pulse Response (VIN = 1.5V to 1.75V, RF = 5.36 MΩ, RI = 79.6 kΩ).

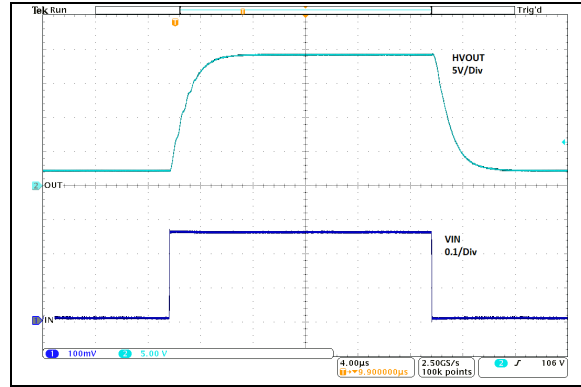

FIGURE 2-10: Typical Small Signal Pulse Response (VIN = 1.5V to 1.75V, RF = 536 kΩ, RI = 7.97 kΩ).

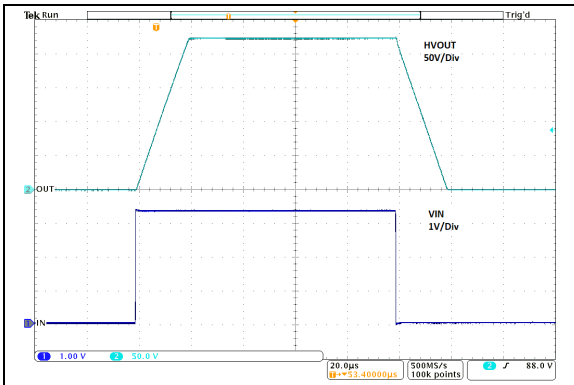

FIGURE 2-8: Typical Small Signal Pulse Response (VIN = 0V to 3.3V, RF = 5.36 MΩ, RI = 79.6 kΩ).

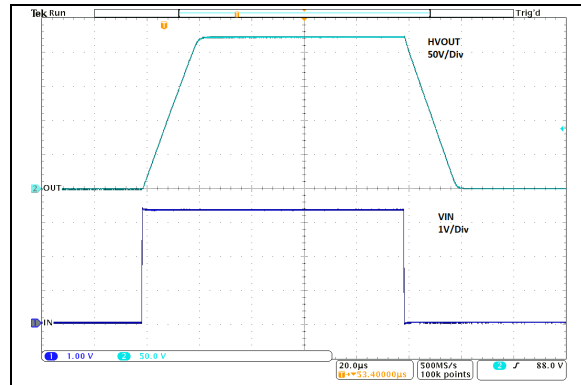

FIGURE 2-11: Typical Small Signal Pulse Response (VIN = 0V to 3.3V, RF = 536 kΩ, RI = 7.97 kΩ).

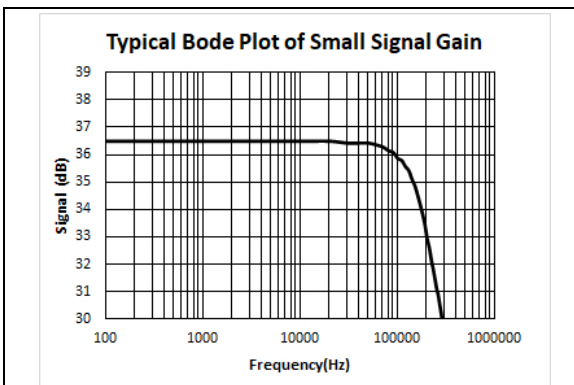

FIGURE 2-9: Typical Bode Plot of Small Signal Gain (VIN = 1.5V + 0.2AC).

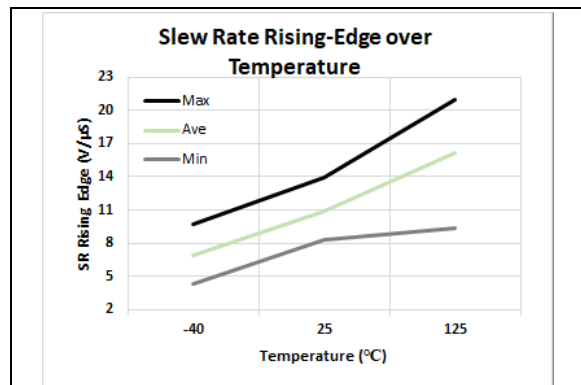

FIGURE 2-12: Slew Rate Rising-Edge Variation Over Temperature.

Note: The graphs and tables provided following this note are a statistical summary based on a limited number of samples and are provided for informational purposes only. The performance characteristics listed herein are not tested or guaranteed. In some graphs or tables, the data presented may be outside the specified operating range (e.g., outside specified power supply range) and therefore outside the warranted range.

Note: Unless otherwise indicated: VDD = 5.0V, VPP = 225V, VIN = 0V, RF = 5.36 MΩ, RI = 79.6 kΩ, C_{LOAD} = 15 pF.

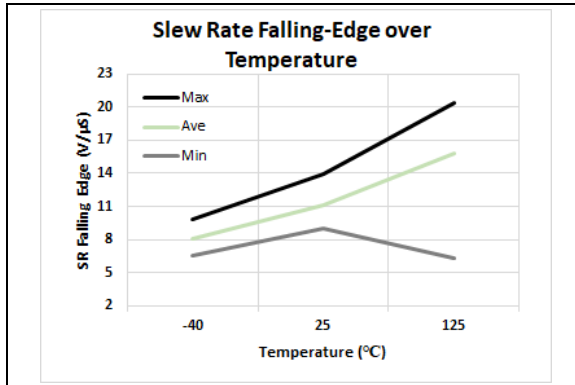

FIGURE 2-13: Slew Rate Falling-Edge Variation Over Temperature.



FIGURE 2-15: PSRR1-VDD (VDD = 5.0V + 0.1 V AC).



FIGURE 2-14: PSRR2-VPP (VPP = 225V + 1V AC).

HV56264

3.0 PACKAGE PIN CONFIGURATION AND DESCRIPTION

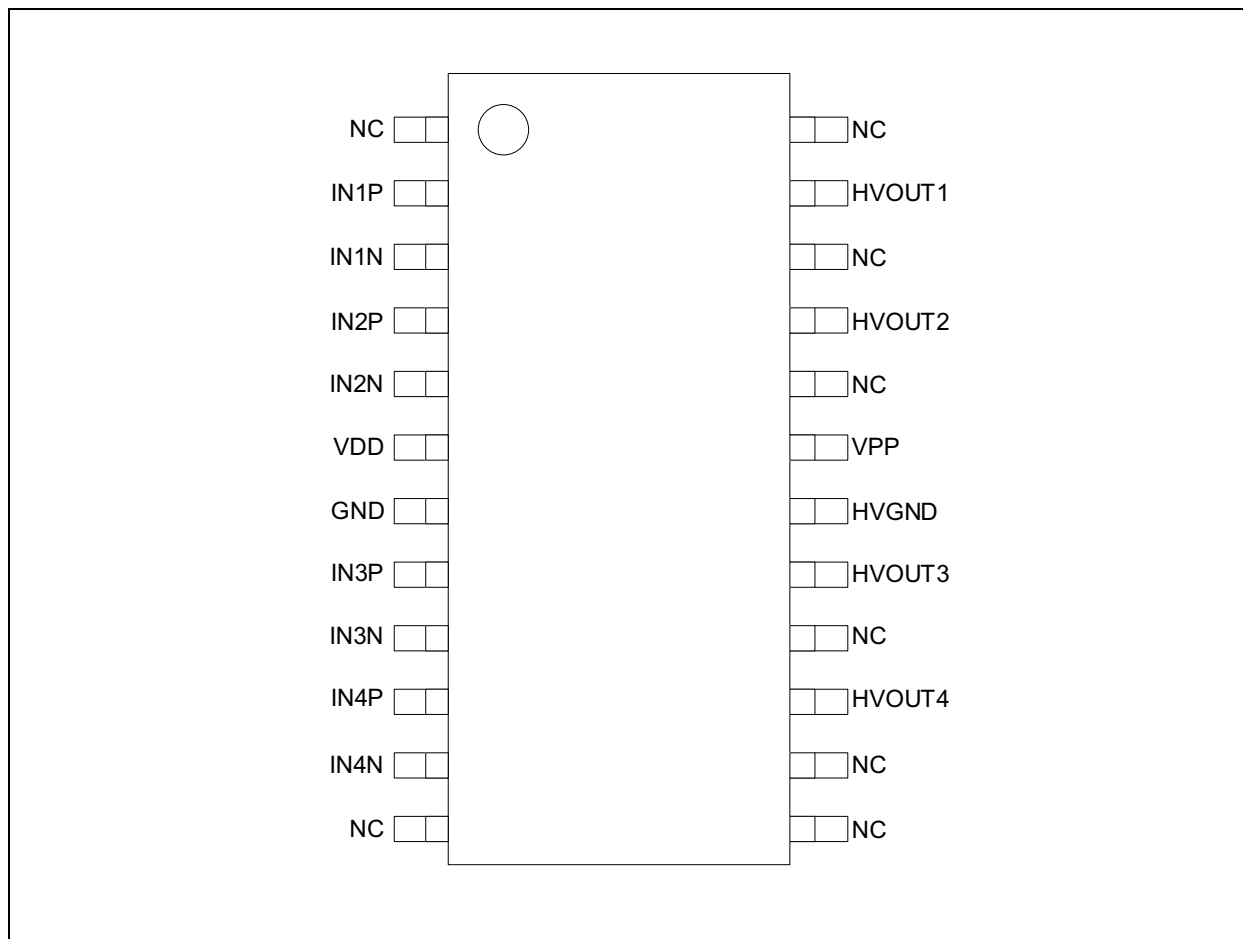

FIGURE 3-1: TSSOP Pinout.

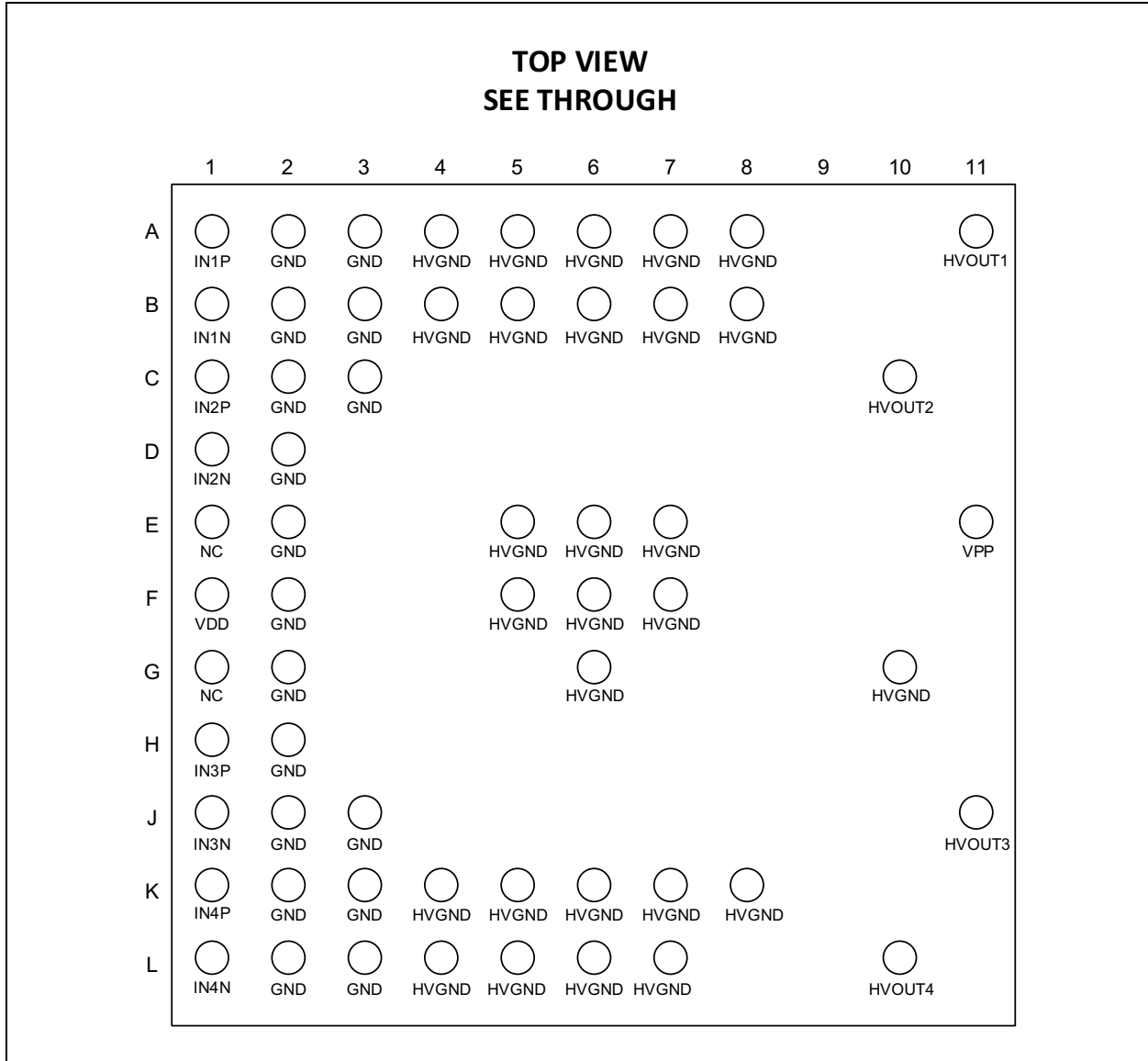

FIGURE 3-2: TFPGA Pinout.

TABLE 3-1: PINOUT CONFIGURATION

TSSOP PIN #	TFBGA PIN #	NAME	FUNCTION
1,12,13,14,16,20,22,24	E1,G1	NC	No Connection
2	A1	IN1P	Amplifier 1 Non-inverting Input
3	B1	IN1N	Amplifier 1 Inverting Input
4	C1	IN2P	Amplifier 2 Non-inverting Input
5	D1	IN2N	Amplifier 2 Inverting Input
6	F1	VDD	Low Voltage Supply
7	A2,A3,B2,B3,C2,C3,D2,E2, F2,G2,H2,J2,J3,K2,K3,L2,L3	GND	Ground
8	H1	IN3P	Amplifier 3 Non-inverting Input
9	J1	IN3N	Amplifier 3 Inverting Input
10	K1	IN4P	Amplifier 4 Non-inverting Input
11	L1	IN4N	Amplifier 4 Inverting Input
15	L10	HVOUT4	Amplifier 4 Output
17	J11	HVOUT3	Amplifier 3 Output
18	A4,A5,A6,A7,A8,B4,B5,B6,B7,B8, E5,E6,E7,F5,F6,F7,G6,G10, K4,K5,K6,K7,K8,L4,L5,L6,L7	HVGND	High Voltage Ground
19	E11	VPP	High Voltage Positive Supply
21	C10	HVOUT2	Amplifier 2 Output
23	A11	HVOUT1	Amplifier 1 Output

3.1 IN1P, IN1N, IN2P, IN2N, IN3P, IN3N, IN4P, IN4N Input pins

Input pins for the amplifiers.

3.2 Low Voltage Supply Input Pin (VDD)

Low voltage supply input pin for the amplifiers.

3.3 High Voltage Positive Supply Input Pin (VPP)

High voltage supply input pin for the amplifiers.

3.4 High Voltage Ground (HVGND)

Ground reference pins for the high voltage amplifiers.

3.5 High Voltage Amplifiers Outputs (HVOUT4, HVOUT3, HVOUT2, HVOUT1)

Amplifiers output pins.

3.6 Ground (GND)

Ground reference for input signals and low voltage supplies.

4.0 FUNCTIONAL DESCRIPTION

The HV56264 is a Quad High Voltage Amplifier Array that can operate up to 225V with a source/sink capability of 3 mA. Amplifiers are designed to deliver a 11 V/ μ s typical output slew rate and sustain a 150 kHz -3 dB Bandwidth for a 15 pF capacitive load.

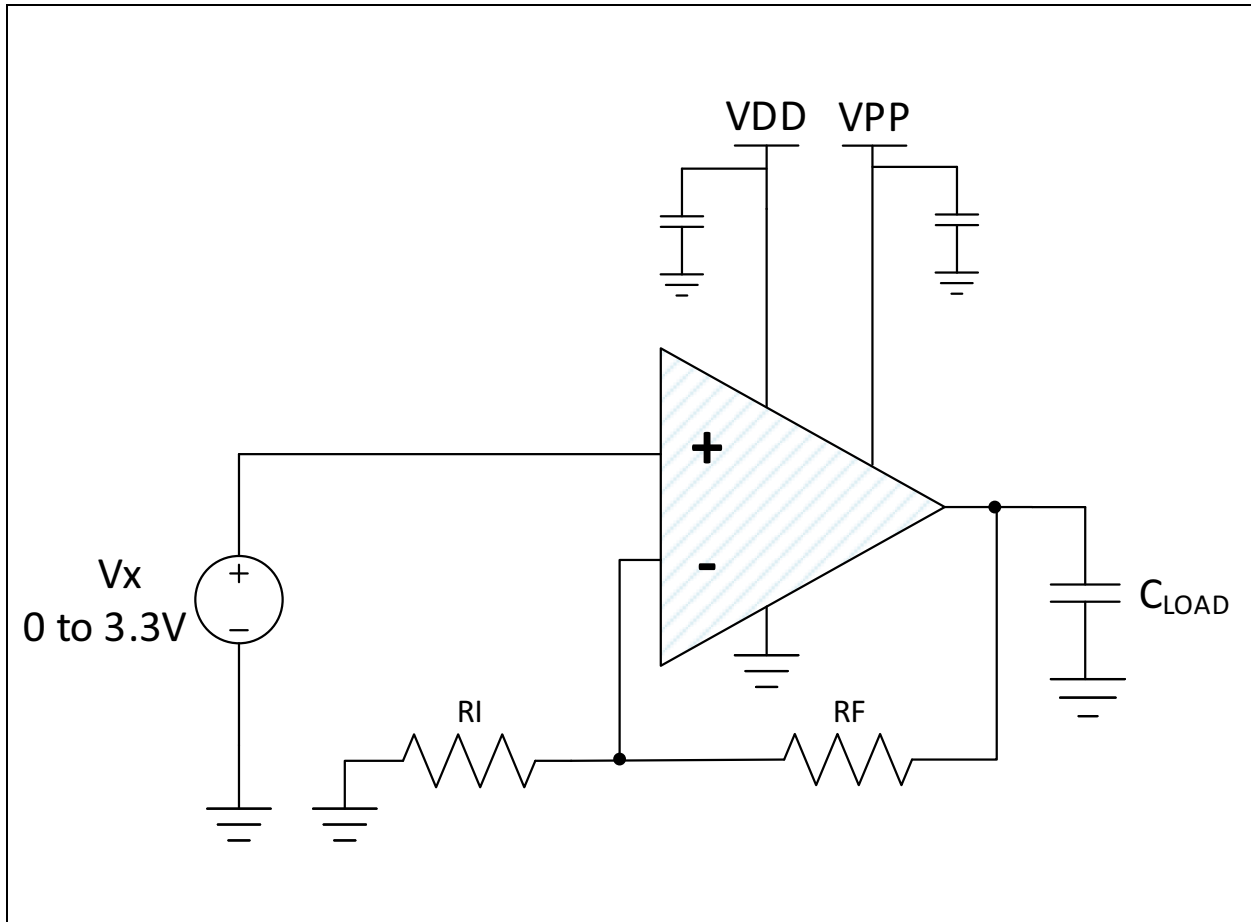

FIGURE 4-1: Functional Block Diagram.

HV56264

5.0 PACKAGING INFORMATION

5.1 Package Marking Information

24-Lead TSSOP

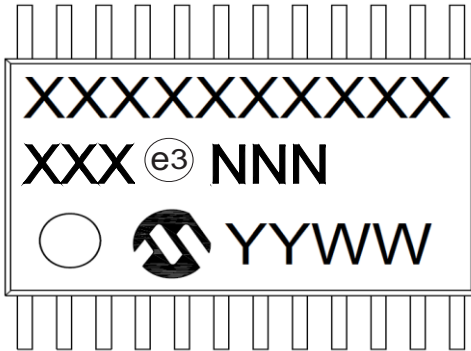

Example

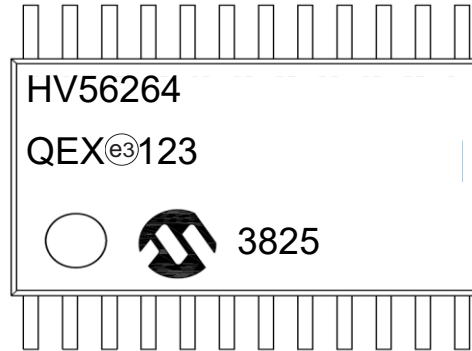

60-Lead TFBGA (6 x 6 mm)

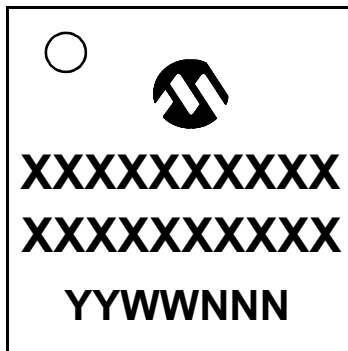

Example

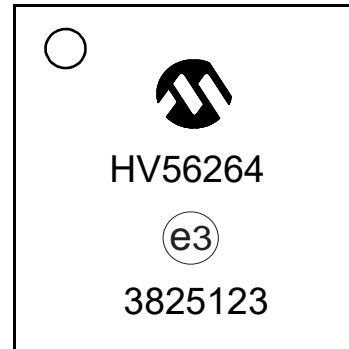

Legend:	XX...X	Product Code or Customer-specific information
	Y	Year code (last digit of calendar year)
	YY	Year code (last 2 digits of calendar year)
	WW	Week code (week of January 1 is week '01')
	NNN	Alphanumeric traceability code
	(e3)	Pb-free JEDEC designator for Matte Tin (Sn)
	*	This package is Pb-free. The Pb-free JEDEC designator (e3) can be found on the outer packaging for this package.

Note: In the event the full Microchip part number cannot be marked on one line, it will be carried over to the next line, thus limiting the number of available characters for customer-specific information. Package may or may not include the corporate logo.

24-Lead Thin Shrink Small Outline Package (QE) - 4.40 mm Body [TSSOP] Supertex Legacy & Micrel Legacy Package

Note: For the most current package drawings, please see the Microchip Packaging Specification located at <http://www.microchip.com/packaging>

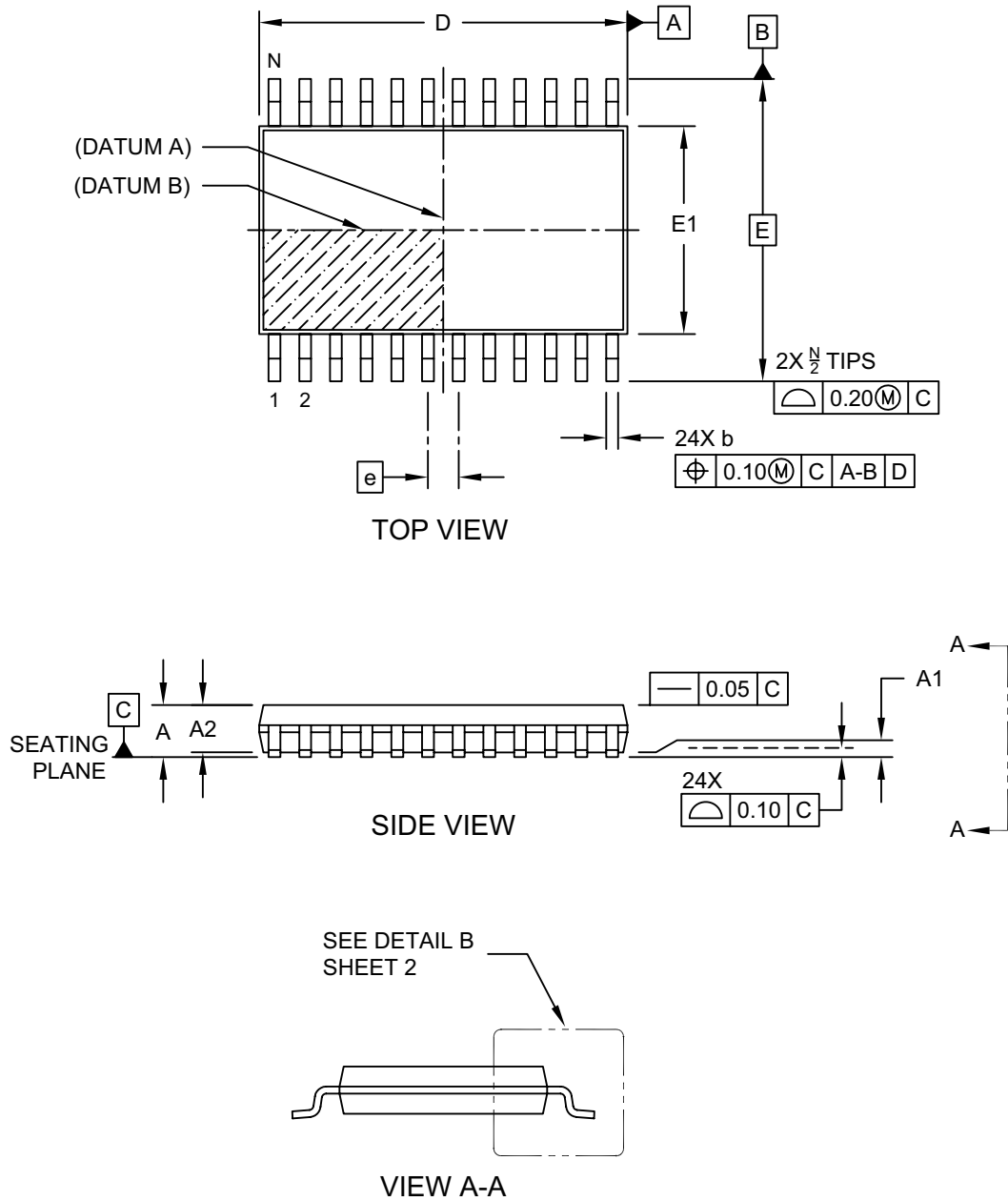

Microchip Technology Drawing C04-284A Sheet 1 of 2

HV56264

24-Lead Thin Shrink Small Outline Package (QE) - 4.40 mm Body [TSSOP] Supertex Legacy & Micrel Legacy Package

Note: For the most current package drawings, please see the Microchip Packaging Specification located at <http://www.microchip.com/packaging>

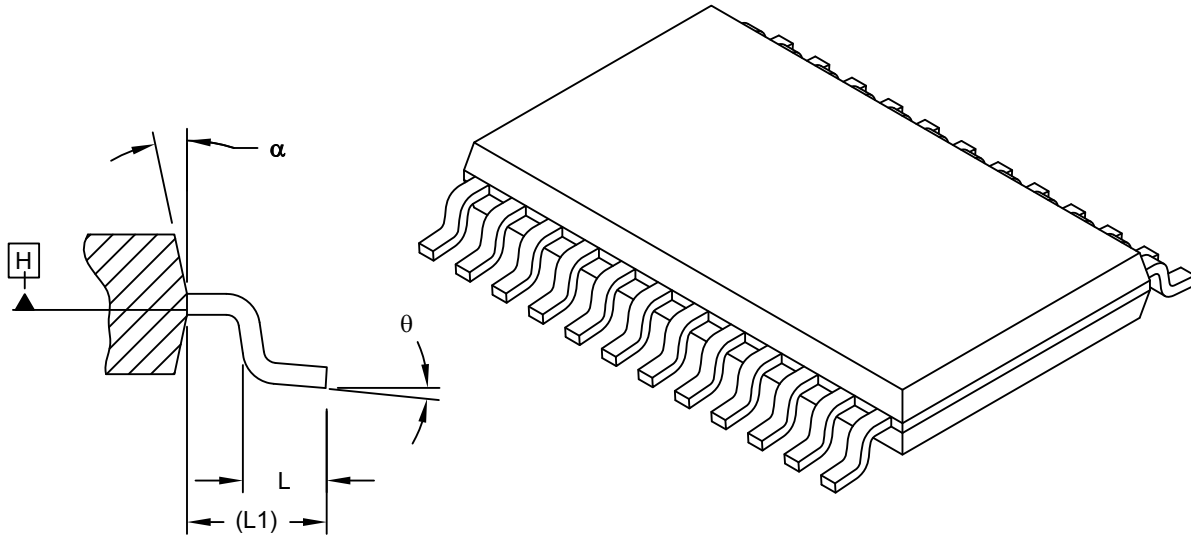

DETAIL B

Dimension Limits	Units	MILLIMETERS		
		MIN	NOM	MAX
Number of Leads	N	24		
Lead Pitch	e	0.65 BSC		
Overall Height	A	0.85	-	1.20
Standoff	A1	0.05	0.10	0.15
Molded Package Thickness	A2	0.80	1.00	1.15
Foot Length	L	0.45	0.60	0.75
Footprint	L1	1.00 REF		
Foot Angle	θ	0°	4°	8°
Overall Width	E	6.40 BSC		
Overall Length	D	7.70	7.80	7.90
Molded Package Width	E1	4.30	4.40	4.50
Lead Width	b	0.19	-	0.30
Mold Draft Angle Top	α	12° REF		

Notes:

1. Pin 1 visual index feature may vary, but must be located within the hatched area.
2. Dimensioning and tolerancing per ASME Y14.5M
 BSC: Basic Dimension. Theoretically exact value shown without tolerances.
 REF: Reference Dimension, usually without tolerance, for information purposes only.

Microchip Technology Drawing C04-284A Sheet 2 of 2

24-Lead Thin Shrink Small Outline Package (QE) - 4.40 mm Body [TSSOP] Supertex Legacy & Micrel Legacy Package

Note: For the most current package drawings, please see the Microchip Packaging Specification located at <http://www.microchip.com/packaging>

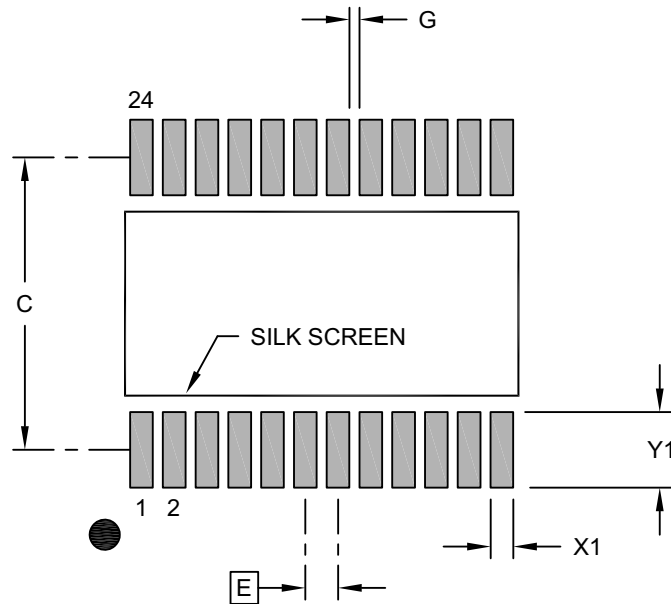

RECOMMENDED LAND PATTERN

Dimension Limits	Units	MILLIMETERS		
		MIN	NOM	MAX
Contact Pitch	E	0.65 BSC		
Contact Pad Spacing	C		5.80	
Contact Pad Width (X24)	X1			0.45
Contact Pad Length (X24)	Y1			1.50
Contact Pad to Center Pad (X20)	G1	0.20		

Notes:

- Dimensioning and tolerancing per ASME Y14.5M
BSC: Basic Dimension. Theoretically exact value shown without tolerances.
- For best soldering results, thermal vias, if used, should be filled or tented to avoid solder loss during reflow process

Microchip Technology Drawing C04-2284A

HV56264

60-Ball Thin Fine-Pitch Ball Grid Array (AKA) - 6x6x1.20 mm Body [TFBGA]

Note: For the most current package drawings, please see the Microchip Packaging Specification located at <http://www.microchip.com/packaging>

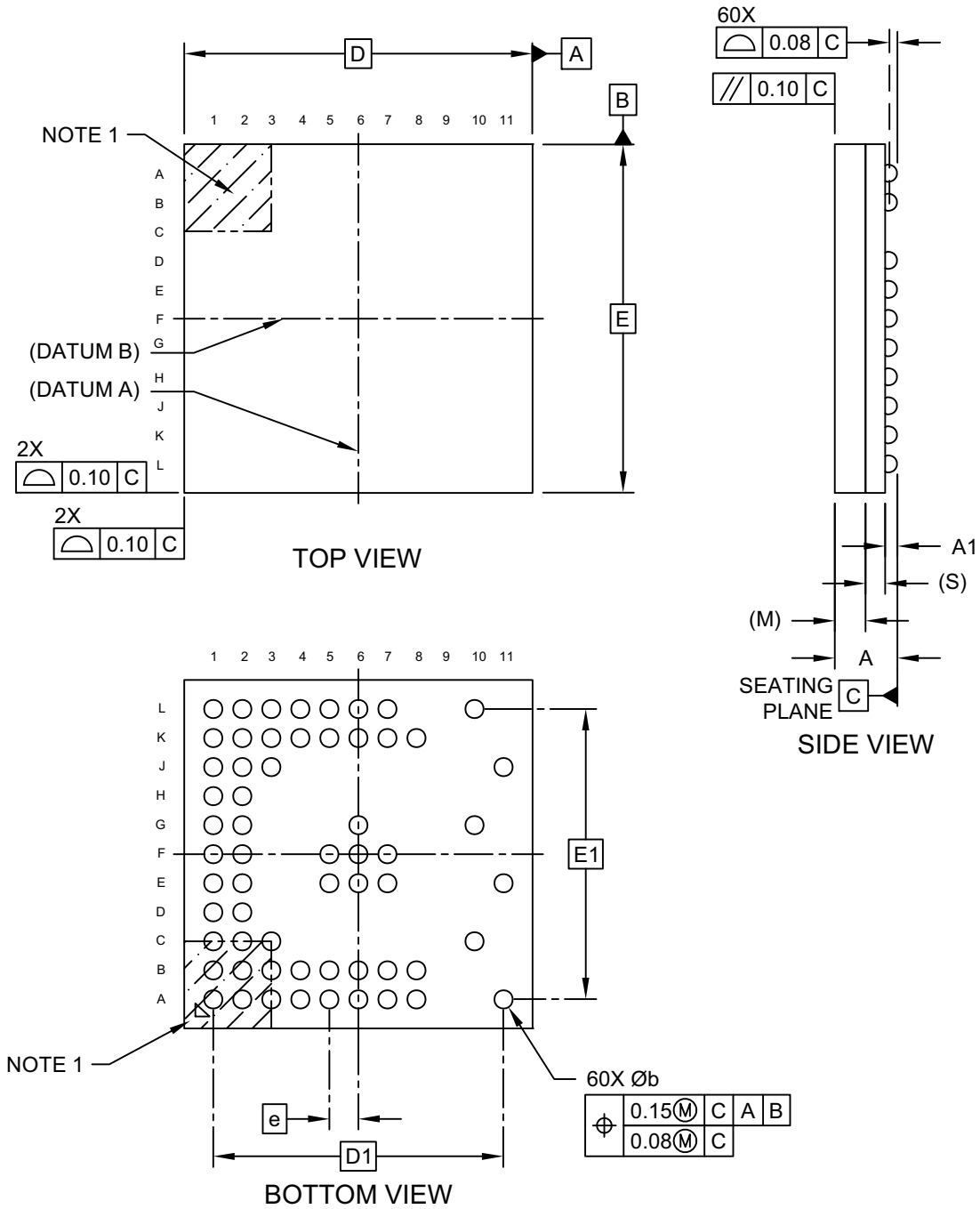

Microchip Technology Drawing C04-1277 Rev A Sheet 1 of 2

60-Ball Thin Fine-Pitch Ball Grid Array (AKA) - 6x6x1.20 mm Body [TFBGA]

Note: For the most current package drawings, please see the Microchip Packaging Specification located at <http://www.microchip.com/packaging>

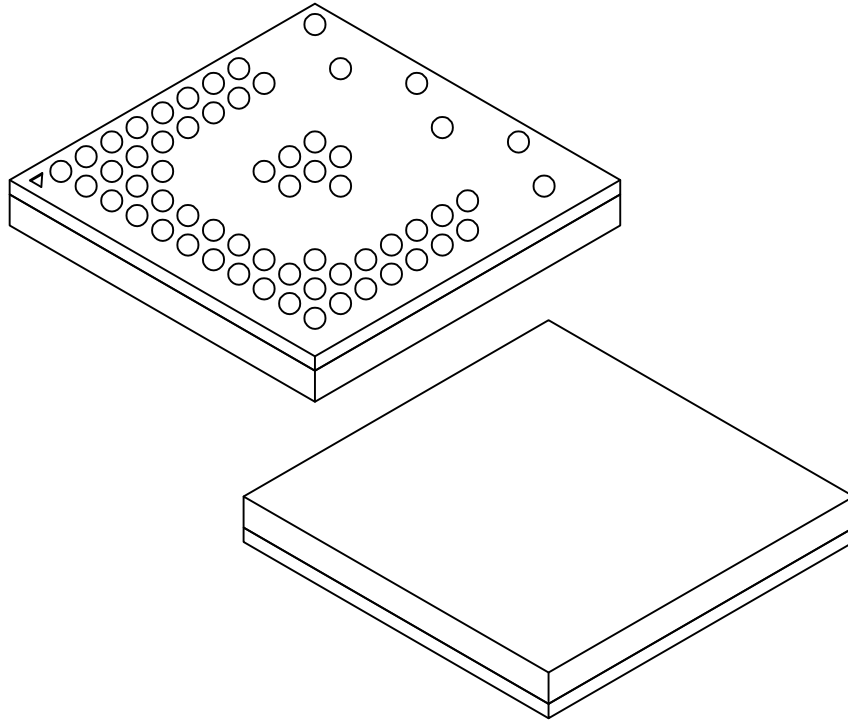

Dimension Limits	Units	MILLIMETERS		
		MIN	NOM	MAX
Number of Terminals	N	60		
Pitch	e	0.50 BSC		
Overall Height	A	–	–	1.20
Ball Height	A1	0.16	–	0.26
Mold Thickness	M	0.53 REF		
Substrate Thickness	S	0.248 REF		
Overall Length	D	6.00 BSC		
Ball Array Length	D1	5.00 BSC		
Overall Width	E	6.00 BSC		
Ball Array Width	E1	5.00 BSC		
Ball Width	b	0.27	0.30	0.37

Notes:

- Pin 1 visual index feature may vary, but must be located within the hatched area.
- Package is saw singulated
- Dimensioning and tolerancing per ASME Y14.5M
 BSC: Basic Dimension. Theoretically exact value shown without tolerances.
 REF: Reference Dimension, usually without tolerance, for information purposes only.

HV56264

60-Ball Thin Fine-Pitch Ball Grid Array (AKA) - 6x6x1.20 mm Body [TFBGA]

Note: For the most current package drawings, please see the Microchip Packaging Specification located at <http://www.microchip.com/packaging>

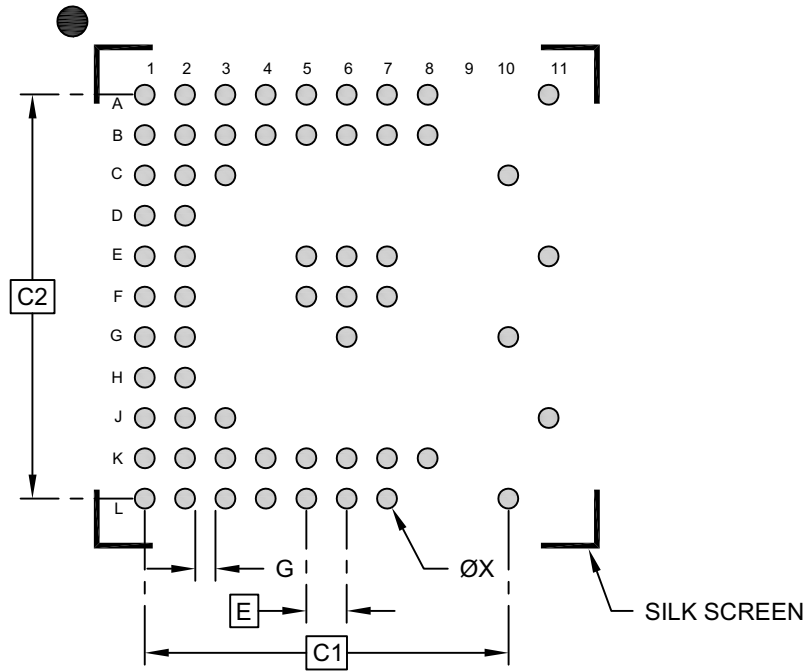

RECOMMENDED LAND PATTERN

Dimension Limits	Units	MILLIMETERS		
		MIN	NOM	MAX
Contact Pitch	E		0.50 BSC	
Contact Pad Spacing	C1		5.00 BSC	
Contact Pad Spacing	C2		5.00 BSC	
Contact Pad Width (X60)	X			0.25
Space Between Contact Pads	G	0.25		

Notes:

1. Dimensioning and tolerancing per ASME Y14.5M
BSC: Basic Dimension. Theoretically exact value shown without tolerances.

Microchip Technology Drawing C04-3277 Rev A

APPENDIX A: REVISION HISTORY

Revision B (January 2021)

The following is the list of modifications:

- Updated the [DC Electrical Characteristics](#) table.
- Minor typographical and layout edits.

Revision A (December 2020)

- Initial Release of this Document.

HV56264

NOTES:

PRODUCT IDENTIFICATION SYSTEM

To order or obtain information, e.g., on pricing or delivery, refer to the factory or the listed sales office.

<u>PART NO.</u>	<u>X⁽¹⁾</u>	<u>-X</u>	<u>/XXX</u>	<u>-XXX</u>	Examples:
Device	Tape and Reel Option	Temperature Range	Package	Option	
Device:	HV56264: Quad High Voltage Amplifier Array				a) HV56264T-E/QEX-VAO: Quad High-Voltage Amplifier Array, Automotive Grade, 24-Lead TSSOP package, 2500 Reel
Media Type	T = 2500/Reel for QEX Package = 3000/Reel for AKA Package				b) HV56264T-E/AKA-VAO: Quad High-Voltage Amplifier Array, Automotive Grade, 60-Terminal Count TFBGA package, 3000/Reel
Temperature Range:	E = -40°C to +125°C (Extended) RoHS Compliant				
Package:	QEX = 24LD TSSOP 6.4x4.4 mm AKA = 60-Ball Count TFBGA 6x6x1.2 mm				
Option	VAO = Automotive Grade				Note 1: Tape and Reel identifier only appears in the catalog part number description. This identifier is used for ordering purposes and is not printed on the device package. Check with your Microchip Sales Office for package availability with the Tape and Reel option.

HV56264

NOTES:

Note the following details of the code protection feature on Microchip devices:

- Microchip products meet the specifications contained in their particular Microchip Data Sheet.
- Microchip believes that its family of products is secure when used in the intended manner and under normal conditions.
- There are dishonest and possibly illegal methods being used in attempts to breach the code protection features of the Microchip devices. We believe that these methods require using the Microchip products in a manner outside the operating specifications contained in Microchip's Data Sheets. Attempts to breach these code protection features, most likely, cannot be accomplished without violating Microchip's intellectual property rights.
- Microchip is willing to work with any customer who is concerned about the integrity of its code.
- Neither Microchip nor any other semiconductor manufacturer can guarantee the security of its code. Code protection does not mean that we are guaranteeing the product is "unbreakable". Code protection is constantly evolving. We at Microchip are committed to continuously improving the code protection features of our products. Attempts to break Microchip's code protection feature may be a violation of the Digital Millennium Copyright Act. If such acts allow unauthorized access to your software or other copyrighted work, you may have a right to sue for relief under that Act.

Information contained in this publication is provided for the sole purpose of designing with and using Microchip products. Information regarding device applications and the like is provided only for your convenience and may be superseded by updates. It is your responsibility to ensure that your application meets with your specifications.

THIS INFORMATION IS PROVIDED BY MICROCHIP "AS IS". MICROCHIP MAKES NO REPRESENTATIONS OR WARRANTIES OF ANY KIND WHETHER EXPRESS OR IMPLIED, WRITTEN OR ORAL, STATUTORY OR OTHERWISE, RELATED TO THE INFORMATION INCLUDING BUT NOT LIMITED TO ANY IMPLIED WARRANTIES OF NON-INFRINGEMENT, MERCHANTABILITY, AND FITNESS FOR A PARTICULAR PURPOSE OR WARRANTIES RELATED TO ITS CONDITION, QUALITY, OR PERFORMANCE.

IN NO EVENT WILL MICROCHIP BE LIABLE FOR ANY INDIRECT, SPECIAL, PUNITIVE, INCIDENTAL OR CONSEQUENTIAL LOSS, DAMAGE, COST OR EXPENSE OF ANY KIND WHATSOEVER RELATED TO THE INFORMATION OR ITS USE, HOWEVER CAUSED, EVEN IF MICROCHIP HAS BEEN ADVISED OF THE POSSIBILITY OR THE DAMAGES ARE FORESEEABLE. TO THE FULLEST EXTENT ALLOWED BY LAW, MICROCHIP'S TOTAL LIABILITY ON ALL CLAIMS IN ANY WAY RELATED TO THE INFORMATION OR ITS USE WILL NOT EXCEED THE AMOUNT OF FEES, IF ANY, THAT YOU HAVE PAID DIRECTLY TO MICROCHIP FOR THE INFORMATION. Use of Microchip devices in life support and/or safety applications is entirely at the buyer's risk, and the buyer agrees to defend, indemnify and hold harmless Microchip from any and all damages, claims, suits, or expenses resulting from such use. No licenses are conveyed, implicitly or otherwise, under any Microchip intellectual property rights unless otherwise stated.

Trademarks

The Microchip name and logo, the Microchip logo, Adaptec, AnyRate, AVR, AVR logo, AVR Freaks, BesTime, BitCloud, chipKIT, chipKIT logo, CryptoMemory, CryptoRF, dsPIC, FlashFlex, flexPWR, HELDO, IGL00, JukeBlox, KeeLoq, Kleer, LANCheck, LinkMD, maXStylus, maXTouch, MediaLB, megaAVR, Microsemi, Microsemi logo, MOST, MOST logo, MPLAB, OptoLyzr, PackeTime, PIC, picoPower, PICSTART, PIC32 logo, PolarFire, Prochip Designer, QTouch, SAM-BA, SenGenuity, SpyNIC, SST, SST Logo, SuperFlash, Symmetricom, SyncServer, Tachyon, TimeSource, tinyAVR, UNI/O, Vectron, and XMEGA are registered trademarks of Microchip Technology Incorporated in the U.S.A. and other countries.

AgileSwitch, APT, ClockWorks, The Embedded Control Solutions Company, EtherSynch, FlashTec, Hyper Speed Control, HyperLight Load, IntelliMOS, Libero, motorBench, mTouch, Powermite 3, Precision Edge, ProASIC, ProASIC Plus, ProASIC Plus logo, Quiet-Wire, SmartFusion, SyncWorld, Temux, TimeCesium, TimeHub, TimePictra, TimeProvider, WinPath, and ZL are registered trademarks of Microchip Technology Incorporated in the U.S.A.

Adjacent Key Suppression, AKS, Analog-for-the-Digital Age, Any Capacitor, AnyIn, AnyOut, Augmented Switching, BlueSky, BodyCom, CodeGuard, CryptoAuthentication, CryptoAutomotive, CryptoCompanion, CryptoController, dsPICDEM, dsPICDEM.net, Dynamic Average Matching, DAM, ECAN, Espresso T1S, EtherGREEN, IdealBridge, In-Circuit Serial Programming, ICSP, INICnet, Intelligent Paralleling, Inter-Chip Connectivity, JitterBlocker, maxCrypto, maxView, memBrain, Mindi, MiWi, MPASM, MPF, MPLAB Certified logo, MPLIB, MPLINK, MultiTRAK, NetDetach, Omniscient Code Generation, PICDEM, PICDEM.net, PICkit, PICtail, PowerSmart, PureSilicon, QMatrix, REAL ICE, Ripple Blocker, RTAX, RTG4, SAM-ICE, Serial Quad I/O, simpleMAP, SimpliPHY, SmartBuffer, SMART-I.S., storClad, SQL, SuperSwitcher, SuperSwitcher II, Switchtec, SynchroPHY, Total Endurance, TSHARC, USBCheck, VariSense, VectorBlox, VeriPHY, ViewSpan, WiperLock, XpressConnect, and ZENA are trademarks of Microchip Technology Incorporated in the U.S.A. and other countries.

SQTP is a service mark of Microchip Technology Incorporated in the U.S.A.

The Adaptec logo, Frequency on Demand, Silicon Storage Technology, and Symmcom are registered trademarks of Microchip Technology Inc. in other countries.

GestIC is a registered trademark of Microchip Technology Germany II GmbH & Co. KG, a subsidiary of Microchip Technology Inc., in other countries.

All other trademarks mentioned herein are property of their respective companies.

© 2021, Microchip Technology Incorporated, All Rights Reserved.

ISBN: 978-1-5224-7480-7

For information regarding Microchip's Quality Management Systems, please visit www.microchip.com/quality.



MICROCHIP

Worldwide Sales and Service

AMERICAS

Corporate Office
2355 West Chandler Blvd.
Chandler, AZ 85224-6199
Tel: 480-792-7200
Fax: 480-792-7277
Technical Support:
<http://www.microchip.com/support>
Web Address:
www.microchip.com

Atlanta

Duluth, GA
Tel: 678-957-9614
Fax: 678-957-1455

Austin, TX

Tel: 512-257-3370

Boston

Westborough, MA
Tel: 774-760-0087
Fax: 774-760-0088

Chicago

Itasca, IL
Tel: 630-285-0071
Fax: 630-285-0075

Dallas

Addison, TX
Tel: 972-818-7423
Fax: 972-818-2924

Detroit

Novi, MI
Tel: 248-848-4000

Houston, TX

Tel: 281-894-5983

Indianapolis

Noblesville, IN
Tel: 317-773-8323
Fax: 317-773-5453
Tel: 317-536-2380

Los Angeles

Mission Viejo, CA
Tel: 949-462-9523
Fax: 949-462-9608
Tel: 951-273-7800

Raleigh, NC

Tel: 919-844-7510

New York, NY

Tel: 631-435-6000

San Jose, CA

Tel: 408-735-9110
Tel: 408-436-4270

Canada - Toronto

Tel: 905-695-1980
Fax: 905-695-2078

ASIA/PACIFIC

Australia - Sydney
Tel: 61-2-9868-6733

China - Beijing
Tel: 86-10-8569-7000

China - Chengdu
Tel: 86-28-8665-5511

China - Chongqing
Tel: 86-23-8980-9588

China - Dongguan
Tel: 86-769-8702-9880

China - Guangzhou
Tel: 86-20-8755-8029

China - Hangzhou
Tel: 86-571-8792-8115

China - Hong Kong SAR
Tel: 852-2943-5100

China - Nanjing
Tel: 86-25-8473-2460

China - Qingdao
Tel: 86-532-8502-7355

China - Shanghai
Tel: 86-21-3326-8000

China - Shenyang
Tel: 86-24-2334-2829

China - Shenzhen
Tel: 86-755-8864-2200

China - Suzhou
Tel: 86-186-6233-1526

China - Wuhan
Tel: 86-27-5980-5300

China - Xian
Tel: 86-29-8833-7252

China - Xiamen
Tel: 86-592-2388138

China - Zhuhai
Tel: 86-756-3210040

ASIA/PACIFIC

India - Bangalore
Tel: 91-80-3090-4444

India - New Delhi
Tel: 91-11-4160-8631

India - Pune
Tel: 91-20-4121-0141

Japan - Osaka
Tel: 81-6-6152-7160

Japan - Tokyo
Tel: 81-3-6880-3770

Korea - Daegu
Tel: 82-53-744-4301

Korea - Seoul
Tel: 82-2-554-7200

Malaysia - Kuala Lumpur
Tel: 60-3-7651-7906

Malaysia - Penang
Tel: 60-4-227-8870

Philippines - Manila
Tel: 63-2-634-9065

Singapore
Tel: 65-6334-8870

Taiwan - Hsin Chu
Tel: 886-3-577-8366

Taiwan - Kaohsiung
Tel: 886-7-213-7830

Taiwan - Taipei
Tel: 886-2-2508-8600

Thailand - Bangkok
Tel: 66-2-694-1351

Vietnam - Ho Chi Minh
Tel: 84-28-5448-2100

EUROPE

Austria - Wels
Tel: 43-7242-2244-39
Fax: 43-7242-2244-393

Denmark - Copenhagen
Tel: 45-4485-5910
Fax: 45-4485-2829

Finland - Espoo
Tel: 358-9-4520-820

France - Paris
Tel: 33-1-69-53-63-20
Fax: 33-1-69-30-90-79

Germany - Garching
Tel: 49-8931-9700

Germany - Haan
Tel: 49-2129-3766400

Germany - Heilbronn
Tel: 49-7131-72400

Germany - Karlsruhe
Tel: 49-721-625370

Germany - Munich
Tel: 49-89-627-144-0
Fax: 49-89-627-144-44

Germany - Rosenheim
Tel: 49-8031-354-560

Israel - Ra'anana
Tel: 972-9-744-7705

Italy - Milan
Tel: 39-0331-742611
Fax: 39-0331-466781

Italy - Padova
Tel: 39-049-7625286

Netherlands - Drunen
Tel: 31-416-690399
Fax: 31-416-690340

Norway - Trondheim
Tel: 47-7288-4388

Poland - Warsaw
Tel: 48-22-3325737

Romania - Bucharest
Tel: 40-21-407-87-50

Spain - Madrid
Tel: 34-91-708-08-90
Fax: 34-91-708-08-91

Sweden - Gothenberg
Tel: 46-31-704-60-40

Sweden - Stockholm
Tel: 46-8-5090-4654

UK - Wokingham
Tel: 44-118-921-5800
Fax: 44-118-921-5820