

DESCRIPTION

HV7121B-COB is a highly integrated single chip CMOS color image sensor module with HV7121B CMOS color image sensor using Hynix 0.5um CMOS process developed for image application to realize high efficiency R/G/B photo sensor. The sensor has 414X314 pixels total, and 400X300 pixels effective. Each pixel is high photo sensitive, small size active pixel element that converts photons to analog voltage signal. The sensor has three on-chip 8 bit Digital to Analog Convert (DAC) and 414 comparators to digitize the pixel output. The three on-chip 8 bit DAC can be used for independent R/G/B gain control. Hynix proprietary on-chip Correlated Double Sampling (CDS) circuit can reduce Fixed Pattern Noise (FPN) dramatically. The whole 8 bit digital color raw data is directly available on the package pins and just a few control signals are needed for whole chip control, so it is very ease to configure a system using the sensor.

FEATURES

- 400 x 300 pixels resolution
- 8um x 8um square pixel
- High efficiency R/G/B color photo sensors
- Integrated 8-bit ADC for direct digital output
- Low power 3.3V operation (5V tolerant I/O)
- Integrated pan control and window sizing
- Clock speed up to 15MHz
- Programmable frame rate and synchronous format
- Full function control through standard I²C bus
- Built-in Automatic Gain Control (AGC)
- 34 pin COB
- Bayer RGB color pattern
- Anti-blooming circuit
- Flexible exposure time control
- Integrated on-chip timing and drive control
- 1/4" optical format

TECHNICAL SPECIFICATION

Pixel resolution	402x302
Pixel size	8x8um ²
Fill factor	30%
Format	CIF
Sensitivity	2.5V/lux·sec
Supply voltage for analog	3.3V
Supply voltage for digital	3.3V
Supply voltage for 5V tolerant input	5.0V
Power Consumption	@15MHz
Operating temperature	0~40 Centigrade
Technology	0.5um 3metal CMOS

FUNCTIONAL BLOCK DIAGRAM

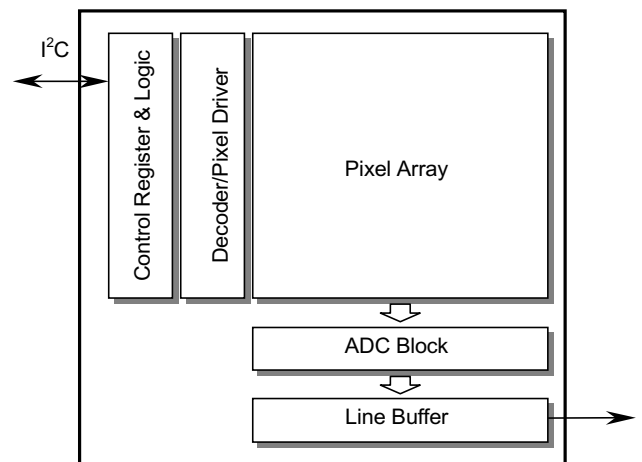

This document is a general product description and is subject to change without notice. Hynix Semiconductor does not assume any responsibility for use of circuits described. NO patent licenses are implied.

ELECTRICAL CHARACTERISTICS

Absolute Maximum Ratings

- Supply voltage(Analog, Digital) : 3.0 V ~ 3.6 V
- Voltage on any input pins : 0 V ~ 5.0 V
- Operating Temperature(Centigrade) : 0 ~ 40
- Storage Temperature(Centigrade) : -30 ~ 80

Note : Input pins are 5V tolerant. Stresses exceeding the absolute maximum ratings may induce failure.

DC Operating Conditions

Symbol	Parameter	Units	Min.	Max.	Load[pF]	Notes
V_{dd}	Internal operation supply voltage	Volt	3.0	3.6		
V_{ih}	Input voltage logic "1"	Volt	2.0	5	6.5	
V_{il}	Input voltage logic "0"	Volt	0	0.8	6.5	
V_{oh}	Output voltage logic "1"	Volt	2.15	3.6	60	
V_{ol}	Output voltage logic "0"	Volt	0.4	0.4	60	
T_a	Ambient operating temperature	Celsius	0	40		

AC Operating Conditions

Symbol	Parameter	Max Operation Frequency	Units	Notes
MCLK	Main clock frequency	20	MHz	1
SCK	I ² C clock frequency	400	KHz	2

1. MCLK can be divided according to Clock Divide Register for internal clock.
2. SCK is driven by host processor. For the detail serial bus timing, refer to I²C Spec.

This document is a general product description and is subject to change without notice. Hynix Semiconductor does not assume any responsibility for use of circuits described. NO patent licenses are implied.

ELECTRO-OPTICAL CHARACTERISTICS

Color temperature of light source: 3,200K / IR cut-off filter (CM-500S, 1mm thickness) is used. --- 8)

Parameter	Units	Min.	Typical	Max.	Note
Sensitivity	mV / lux·sec	1,600	2,500		1)
Dark Signal	mV/sec		5	100	2)
Output Saturation Signal	mV	1,200	1,250		3)
Dynamic Range	dB			48	4)
Output Signal Shading	%		8	13	5)
Dark Signal Shading	mV/sec		3	300	6)
Frame Rate	fps			60	7)

The above characteristics are measured with the HV7121B packaged from CLCC.

Note:

- 1) Measured at 28lux illumination for exposure time 10 ms.
- 2) Measured at zero illumination for exposure time 50 ms. ($T_{temp} = 40$ Centigrade)
- 3) Measured at $V_{dd} = 3.3V$ and 100lux illumination for exposure time 50msec.
- 4) 48dB is limited by 8-bit ADC.
- 5) Variance of average value of 4x4 pixels response of each block over all equal blacks at 50% saturation level illumination for exposure time 10msec.
- 6) Range between V_{max} and V_{min} at zero illumination for exposure time 50msec, where V_{max} and V_{min} are the maximum and minimum values of each block's response, respectively.
- 7) Measured at MCLK 15MHz.
Integration time must be set in order for effective window height not to exceed window height.
It's because effective window height is directly proportional to integration time.
- 8) We recommend the IR cut-off filter with transmittance 50% at cut-off frequency 650nm for the real applications.

This document is a general product description and is subject to change without notice. Hynix Semiconductor does not assume any responsibility for use of circuits described. NO patent licenses are implied.

OPTICAL CHARACTERISTICS (LENS SPECIFICATION)

Parameter		Units	Characteristics
Number of Elements		piece	1 (Aspheric Plastic Lens)
Focal Length		mm	4.0mm +/- 5%
F Number		--	Min. 2.2
MTF(30%)		linepair/mm	Min. 65 (at Center) Min. 40 (at Full Field)
Relative Illumination		%	Min. 75 (at Full Field)
TV Distortion		%	Max. 2.5
View Angle		degree	Min. 57 (Diagonal)
IR cut-off filter	Cut-off frequency	nm	645 +/- 10 (Transmittance 50%)
	Thickness	mm	0.7 +/- 0.05

SOLDERING

Infrared(IR) / Convection solder reflow condition

Parameter	Units	Min.	Typical	Max.	Note
Peak Temperature Range	Celsius	-	230	240	1)

Note :

- 1) Time within 5 Celsius of actual peak temperature, 10sec

This document is a general product description and is subject to change without notice. Hynix Semiconductor does not assume any responsibility for use of circuits described. NO patent licenses are implied.

INPUT / OUTPUT AC CHARACTERISTICS

- All output timing delays are measured with output load 60[pF].
- Output delay include the internal clock path delay 6[ns] and output driving delay that changes in respect to the output load, the operating environment, and a board design.
- Due to the variable valid time delay of the output, output signals may be latched in the negative edge of MCLK for the stable data transfer between the image sensor and a host for less than 15MHz operation.

MCLK to HSYNC/VSYNC Timing

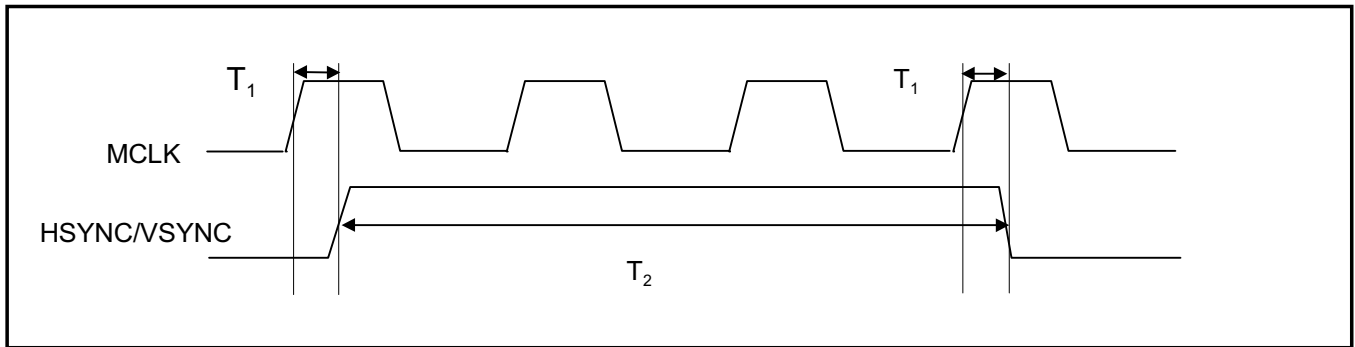

T_1 : MCLK rising to HSYNC/VSYNC valid maximum time : 18ns [output load: 60pF]

T_2 : HSYNC/VSYNC valid time : minimum 1clock(subject to T_1 , T_2 timing rule)

MCLK to DATA Timing

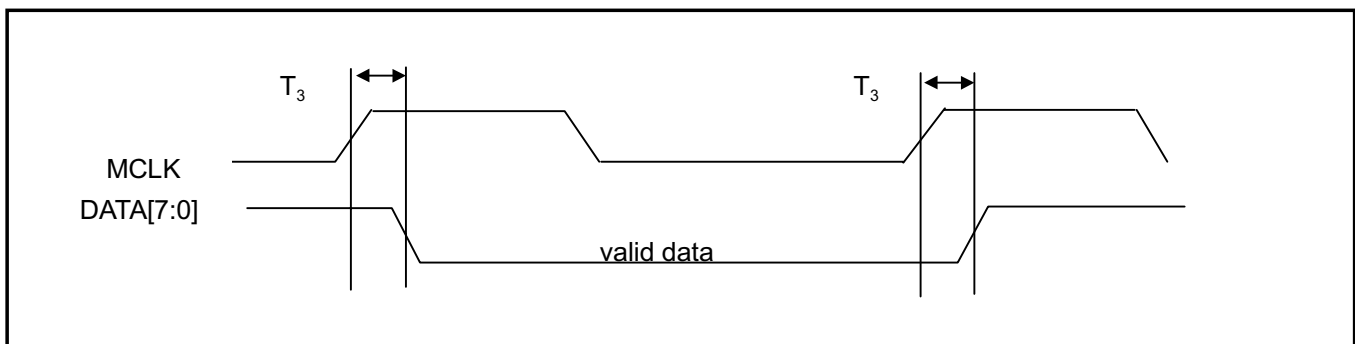

T_3 : MCLK rising to DATA valid maximum time : 18ns [output load: 60pF]

Note) HSYNC signal is high when valid data is on the DATA bus.

This document is a general product description and is subject to change without notice. Hynix Semiconductor does not assume any responsibility for use of circuits described. NO patent licenses are implied.

INPUT / OUTPUT AC CHARACTERISTICS (Continue)

ENB Timing

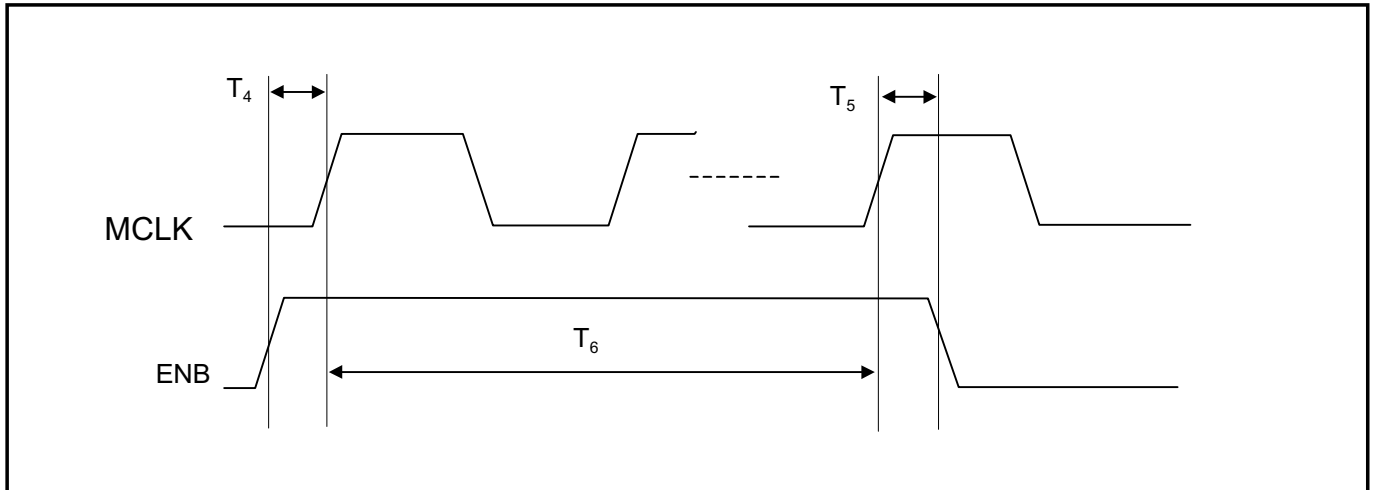

T_4 : ENB Setup Time : 5[ns]

T_5 : ENB Hold Time : 5[ns]

T_6 : ENB valid Time : minimum 2 clock

RESET Timing

Must in Valid (active low) state at least 8 MCLK periods

INPUT / OUTPUT AC CHARACTERISTICS CONTINUE

I²C Bus (Programming Serial Bus) Timing

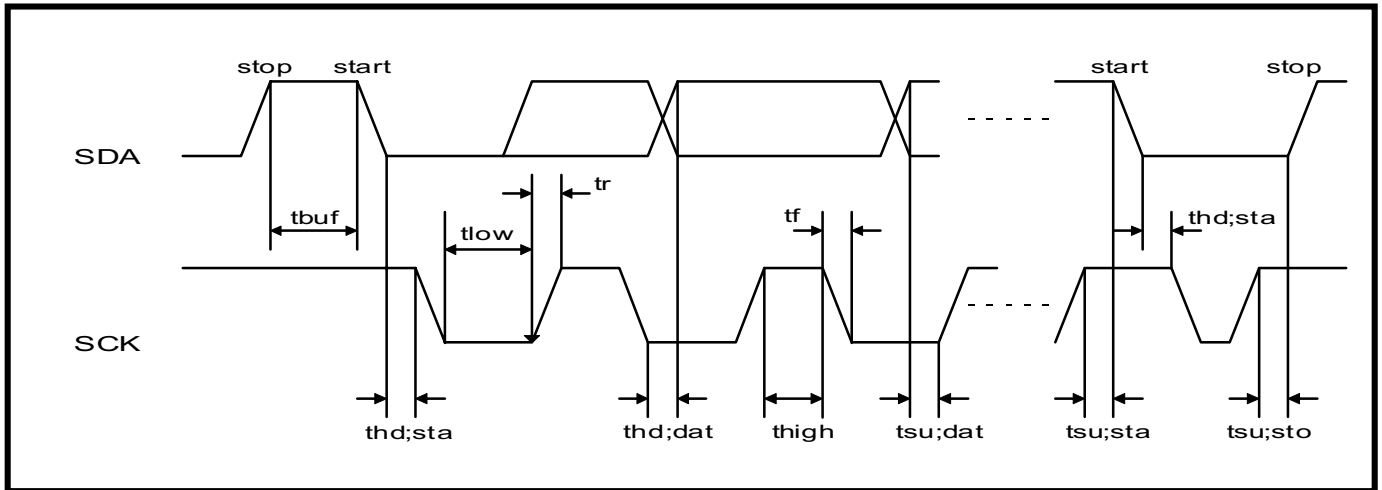

I²C Bus Interface Timing

Parameter	Symbol	Min.	Max.	Unit
SCK clock frequency	f_{sck}	0	400	KHz
Time that I ² C bus must be free before a new transmission can start	t_{buf}	1.2		us
Hold time for a START	$t_{hd};s_{ta}$	1.0		us
LOW period of SCK	t_{low}	1.2		us
HIGH period of SCK	t_{high}	1.0		us
Setup time for START	$t_{su};s_{ia}$	1.2		us
Data hold time	$t_{hd};d_{at}$	1.3		us
Data setup time	$t_{su};d_{at}$	250		ns
Rise time of both SDA and SCK	t_r		250	ns
Fall time of both SDA and SCK	t_f		300	ns
Setup time for STOP	$t_{su};s_{to}$	1.2		us
Capacitive load of each bus lines(SDA,SCK)	C_b			pf

This document is a general product description and is subject to change without notice. Hynix Semiconductor does not assume any responsibility for use of circuits described. NO patent licenses are implied.

PIN CONFIGURATION (34 pin COB)

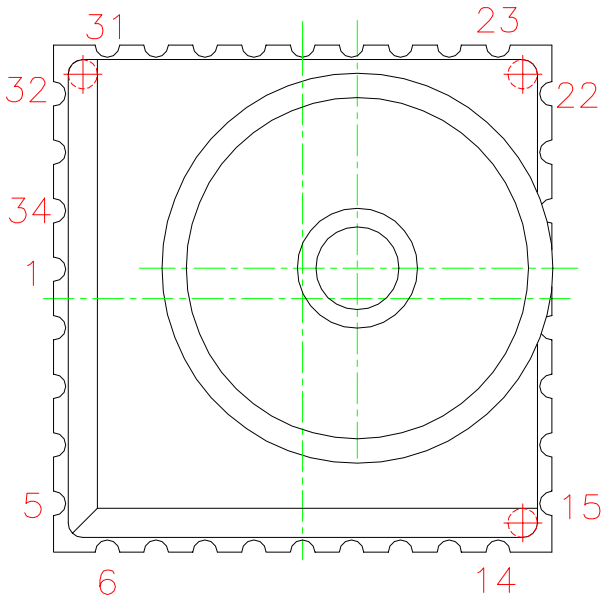

Pin9~16, Pin19~20, Pin33~41 : No Connection

PIN NO.	NAME
1	AGND
2	AVDD
3~5	Reserved
6	DGND
7	DATA7
8	DATA6
9	DATA5
10	DATA4
11	DGND
12	DATA3
13	DATA2
14	DATA1
15	DATA0
16	DVDD
17	Reserved
18	DGND

PIN NO.	NAME
19~20	DVDD
21	RESET
22	VSYNC
23	HSYNC
24	DGND
25	SDA
26	DGND
27	SCK
28	DGND
29	ENB
30	DGND
31	MCLK
32	VDD5
33	AVDD
34	AGND

COLOR PATTERN

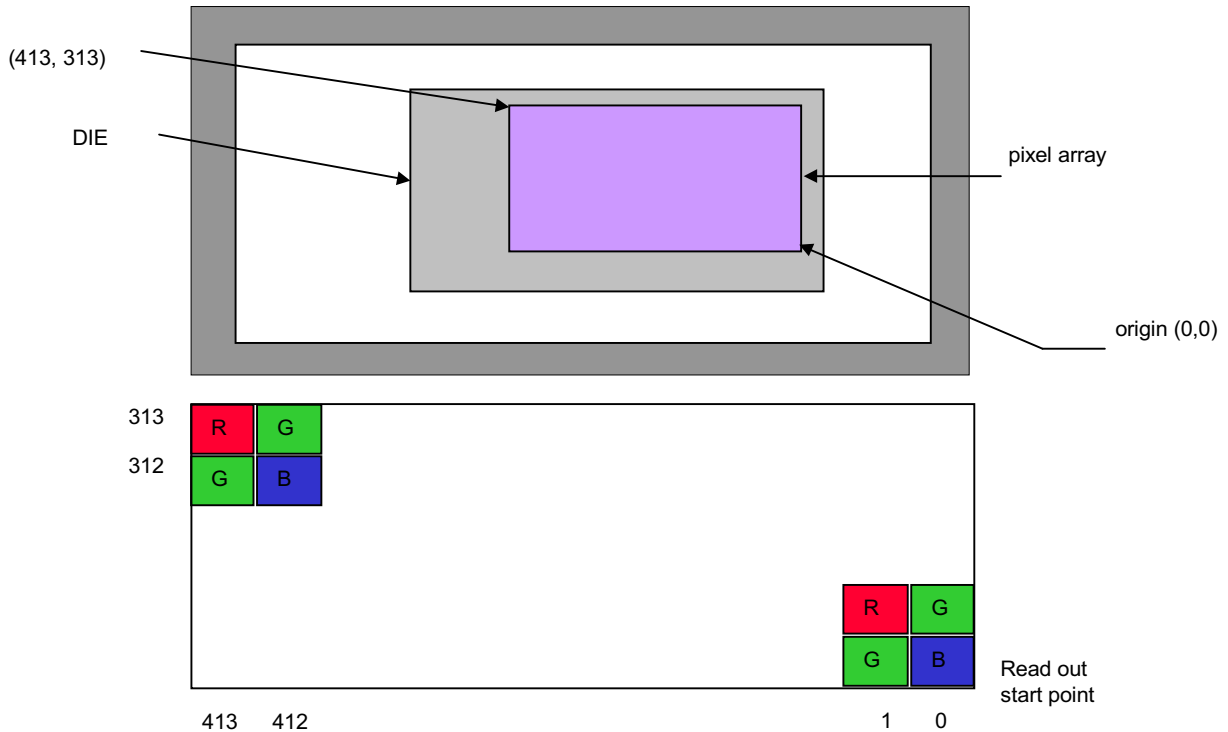

This document is a general product description and is subject to change without notice. Hynix Semiconductor does not assume any responsibility for use of circuits described. NO patent licenses are implied.

PIN DESCRIPTION (34 pin COB)

PIN	NAME	I/O	DESCRIPTION
1	AGND	I	Analog Ground
2	AVDD	I	Analog Supply Voltage 3.3V
3~5	Reserved		Reserved
6	DGND	I	Digital Ground
7	DATA7	O	Image Data bit 7
8	DATA6	O	Image Data bit 6
9	DATA5	O	Image Data bit 5
10	DATA4	O	Image Data bit 4
11	DGND	I	Digital Ground
12	DATA3	O	Image Data bit 3
13	DATA2	O	Image Data bit 2
14	DATA1	O	Image Data bit 1
15	DATA0	O	Image Data bit 0
16	DVDD	I	Digital Supply Voltage 3.3V
17	Reserved		Reserved
18	DGND	I	Digital Core Ground
19~20	DVDD	I	Digital Supply Voltage 3.3V
21	RESET	I	Hardware Reset Signal, Active Low
22	VSYNC	O	Vertical synchronization signal / Frame start output ; Signal pulse at start of image data frame with program-mable blanking duration
23	HSYNC /DVALID	O	Horizontal synchronization signal / Data valid output ; Data valid when 'H' with programmable blanking duration
24	DGND	I	Digital Ground
25	SDA	I/O	I ² C Data ; I ² C standard data I/O port
26	DGND	I	Digital Ground
27	SCK	I	I ² C Clock ; I ² C clock control from I ² C master
28	DGND	I	Digital Ground
29	ENB	I	Sensor Enable Signal ; 'H' enable normal operation 'L' disable sensor
30	DGND	I	Digital Ground
31	MCLK	I	Master Clock (up to 20MHz) ; Global master clock for image sensor internal timing control
32	VDD5	I	I/O bias voltage for 5V tolerant ^{*1)}
33	AVDD	I	Analog Supply Voltage 3.3V
34	AGND	I	Analog Ground

Note 1) Tie to DVDD for 3.3V operation / Tie to 5V for 5V tolerant operation

This document is a general product description and is subject to change without notice. Hynix Semiconductor does not assume any responsibility for use of circuits described. NO patent licenses are implied.

Register map

Register Name	address	7	6	5	4	3	2	1	0
Mode A	00h	model_name				rev_num			
Mode B	01h	oper_mode		data_type		hs_out	scr_size	shot	int_sel
Mode C	02h	reserved				sw_enb	pwr_dn	color	reserved
Row Start Address High	10h	reserved							r_ad[8]
Row Start Address Low	11h	r_ad[7:0]							
Column Start Address High	12h	reserved							c_ad[8]
Column Start Address Low	13h	c_ad[7:0]							
Window Height Address High	14h	reserved							h_ad[8]
Window Height Address Low	15h	h_ad[7:0]							
Window Width Address High	16h	reserved							w_ad[8]
Window Width Address Low	17h	w_ad[7:0]							
HSYNC Blanking Time High	20h	h_blank[15:8]							
HSYNC Blanking Time Low	21h	h_blank[7:0]							
VSYNC Blanking Time High	22h	v_blank[15:8]							
VSYNC Blanking Time Low	23h	v_blank[7:0]							
Integration Time High	25h	int_time[23:16]							
Integration Time Middle	26h	int_time[15:8]							
Integration Time Low	27h	int_time[7:0]							
Master Clock Divider	28h	reserved				clk_div[3:0]			
Reset Level Control	30h	reserved				rst_level[5:0]			
Red Color Gain	31h	reserved		red_color[5:0]					
Green Color Gain	32h	reserved		green_color[5:0]					
Blue Color Gain	33h	reserved		blue_color[5:0]					
Pixel Bias Voltage	34h	reserved				pixel_bias[3:0]			
Red Offset Gain Control	50h	reserved		red_offset[6:0]					
Green Offset Gain Control	51h	reserved		green_offset[6:0]					
Blue Offset Gain Control	52h	reserved		blue_offset[6:0]					
Low Reference Number High	57h	low_ref_no[15:8]							
Low Reference Number Low	58h	low_ref_no[7:0]							
High Reference Number High	59h	high_ref_no[15:8]							
High Reference Number Low	5Ah	high_ref_no[7:0]							

This document is a general product description and is subject to change without notice. Hynix Semiconductor does not assume any responsibility for use of circuits described. NO patent licenses are implied.

Register Set Descriptions

All register access can through the I²C multi-byte read and write.

(1) Mode A Register (Address 00h, RO)

This register consist of a model name and revision number. The upper 4 bits is **model_name** [3:0] and the lower 4 bits is **rev_num**[3:0]. For example it's value 12h, this mean 400*300 resolution and revision2.0 chip.

< model_name >	< rev_num >
400*300 : 0001b	Rev. 2.0 : 0010b

(2) Mode B Register (Address 01h, default : 04h, R/W)

This register defines major operation mode of the chip.

- Mode B[7:6] : oper_mode**(operating mode) *<default value : 00b>*
 Define operating modes between normal operation and optical and function test operation.
 Test operation mode is used for optical and function test. Except for default value, these bits are reserved for manufacturer.

Bit	operating mode
00	Normal operation
01	Reserved
10	Reserved
11	Reserved

This document is a general product description and is subject to change without notice. Hynix Semiconductor does not assume any responsibility for use of circuits described. NO patent licenses are implied.

■ Mode B [5:4] : **data_type**(data types) <default value : 00b>

These bits define output pixel data types. For Correlated Double Sampling(CDS), every the pixel of image sensor are measured twice, reference and data respectively, and reference values or data values can be read out through pixel data pins selectively using these control bits. To remove the noise caused by circuit, i.e. **Fixed Pattern** Noise, the image sensor performs the CDS in default value. Three output data types are supported as follows.

Bit	Output data type
00	Data level - Reference level
01	Reference level
10	Data level
11	Reserved

■ Mode B[3] : **hs_out**(HSYNC output configuration) <default value : 0b>

This bit offers two types output style about HSYNC signal. HSYNC only mode and HSYNC & internal clock mode. If the **hs_out** is set to one, HSYNC output signal is ANDed signal of internal pixel clock and data valid. Otherwise HSYNC output pin keep data high state during valid output period. When HSYNC & internal clock mode is set, HSYNC output can be used as a pixel data output clock.

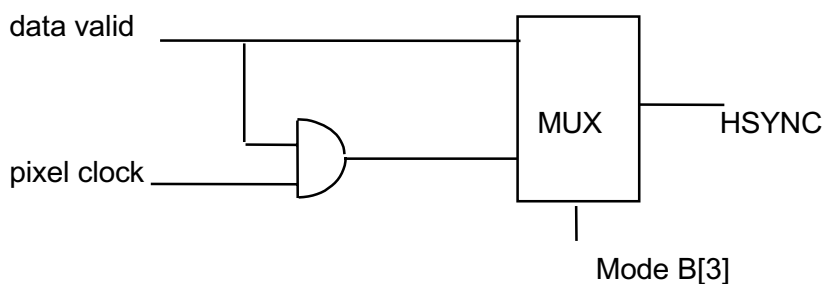

■ Mode B[2] : **scr_size**(screen size select) <default value : 1b>

Flexible screen size is very useful for customer. If the **scr_size** is set to high, i.e. window mode, only pixels in windowed area defined by register 10h ~ 17h can be read. But **scr_size** is set to low state, i.e. full screen mode, all pixels in the sensor are read out regardless the values of register 10h ~ 17h. We can select window mode or full screen mode with this bit. Full screen size is only for chip test.

- window start point :

x : row start address (register 10h, 11h)

y : column start address (register 12h, 13h)

- window end point :

x : row start address + window width address (register 14h, 15h) - 1

y : column start address + window height address (register 16h, 17h) - 1

■ Mode B [1] : **shot**(shot mode) <default value : 0b>

User can select continuous frame mode or snapshot mode according to application.

At the continuous frame mode, pixel data output is updated every VSYNC period. In order to set snapshot mode, it this bit to '1'. In that case, just single frame of pixel data will be read out, then the sensor stops operation. Snapshot mode can be used for the digital still camera applications.

■ Mode B[0] : **int_sel**(integration time unit select) <default value : 0b>

This bit defines integration time unit i.e. line base or pixel clock base.

Default mode is line unit integration but at the bright condition or if you need precise exposure time control, pixel mode is recommended. This bit related to integration time register 25h, 26h, and 27h.

<Note>

Actual integration time can be calculated using three integration time registers and main clock period.

In pixel mode, integration time = (25h, 26h, 27h) * main clock period.

In line mode, integration time = (26h, 27h) * line period.

(cf) line period = 828 * main clock period

(3) Mode C Register (Address 02h, default : 08h, R/W)

This register controls power down and color select.

- Mode C[3] : **sw_enb** (software enable : active low)

(400*300 CMOS image sensor only) <default value : 1b>

This bit is only exist in 400*300 CMOS image sensor chip to enable image sensor operation by software. This bit has same function as ENB pin control.

It's very useful for the applications that is needed want to reduce interface pin count to CMOS image sensor. In that case, cannot ENB pin to VDD line and control the sensor using this bit.

- Mode C[2] : **pwr_dn**(A/D converter power down) <default value : 0b>

This bit controls power down of A/D converter when sleep mode(idle state) is set by ENB pin is low or **sw_enb**(Mode C[3]) is high. When set to high, A/D converter is turned on whenever ENB is low or **sw_enb** is high. When set to low, A/D converter is turned off always regardless ENB pin state or **sw_enb** state . But digital block goes to power down mode always when ENB is low regardless this bit.

- Mode C[1] : **color**(color select) <default value : 0b>

This bit selects color mode or monochrome mode. Default value means color image sensor and all three ADCs are used for Bayer RGB color pattern respectively, then RGB gains are controlled independently. But when set this to one, i.e. monochrome mode, just single ADC is used for all pixels regardless RGB color.

At the monochrome mode all pixels are controlled by 'G' gain only. 'R' and 'B' gain are not used. In case of monochrome image sensor, this bit should be set to '1' get the good image and to simplify the sensor control.

(4) Row start address Register

(Higher byte : Address 10h, default : 00h, R/W)

(Lower byte : Address 11h, default : 06h, R/W)

Define window start position row start address of display window. Should be programmed with value between 6 and 306.

(5) Column start address Register

(Higher byte : Address 12h, default : 00h, R/W)

(Lower byte : Address 13h, default : 06h, R/W)

Define window start position column address of display window. Should be programmed with value between 6 and 406.

(6) Window Height address Register

(Higher byte : Address 14h, default : 01h, R/W)

(Lower byte : Address 15h, default : 2Eh, R/W)

Define display window height. If you need smaller display window height, decrease the value.

Window end position row address = row start address + window height address - 1

(7) Window width address Register

(Higher byte : Address 16h, default : 01h, R/W)

(Lower byte : Address 17h, default : 92h, R/W)

Define display window width. If you need smaller display window width, decrease the value.

Window end position column address = column start address + window width address - 1

Note : Display window programming.

< Display Window Programming >

The 400*300 resolution chip can read any user specific window area within active window area. This is called panning function. For this function, 'row start', 'column start', 'width', and 'height' can be programmed with four sets of register pair.

- FRS : Frame Row Start
- FCS : Frame Column Start
- FWH : Frame window Height
- FWW : Frame Window Width

Panning window can be programmed as below.

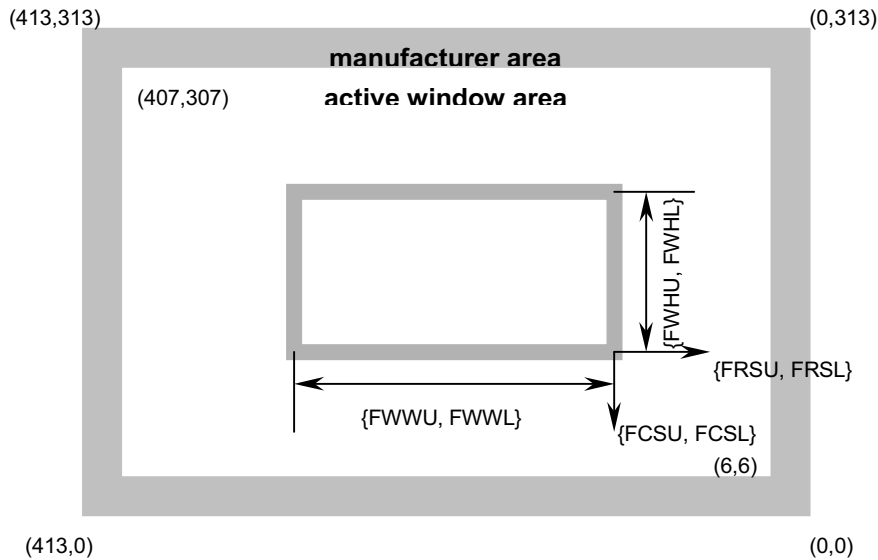

Note 1) Accessible pixel array size is 402*302.

The edge of accessible pixel array may be commonly dedicated for just color interpolation.

In the case of a color image sensor the interpolation is needed to get all R,G,B color value for each pixel from a Bayer color image.

So one more extra pixel line is needed at the edge of pixel array that you want to be displayed.

That is, to make 400*300 effective window, 402*302 pixel array necessary.

You have to consider this interpolation line when you program the 'Frame register'.

For example, if you want to get 300*250 image size, you have to program 302*252 to frame register.

<Default window area>

FRSU, FRSL	6	FWHU, FWHL	302
FCSU, FCSL	6	FWWU, FWWL	402

< Pixel Array Structure >

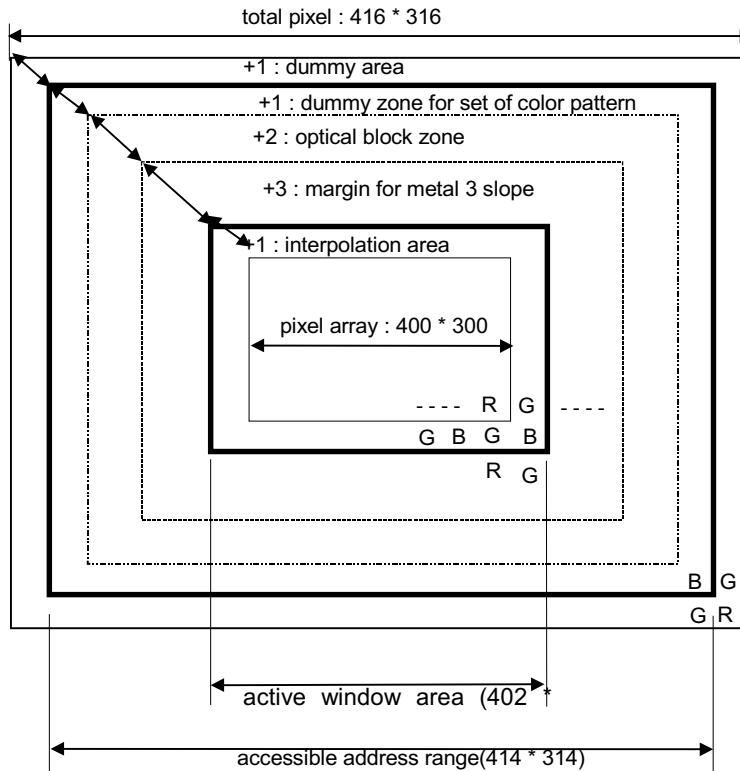

(8) HSYNC Blanking Time Register

(Higher byte : Address 20h, default : 00h, R/W)

(Lower byte : Address 21h, default : 03h, R/W)

HSYNC low duration is HSYNC blanking time plus $(828 - 2 * \text{window width}) * \text{main clock period}$.

It's used to change duration between current line end and next line start.

(9) VSYNC Blanking Time Register

(Higher byte : Address 22h, default : 00h, R/W)

(Lower byte : Address 23h, default : 03h, R/W)

The VSYNC blank, and time defines VSYNC active duration in pixel unit .

<Note>

HSYNC blanking, VSYNC blank are used to fit the CMOS sensor display timing to external timing requirements.

(10) Integration time Register

(High byte : Address 25h, default : 00h, R/W)

(Middle byte : Address 26h, default : 01h, R/W)

(Low byte : Address 27h, default : f4h, R/W)

Each pixel has a photo diode in which the incoming photons are converted to electrons. Integration time mean exposure time so these registers defines exposure time.

According to settings **int_sel** of Mode B register, the integration time is controlled with line or pixel unit. Small value means short exposure time and large value means long exposure time for bright condition.

The value should be large for dark condition. Default value setting 500 lines, this value is useful for normal office condition. If you stay in outdoor condition, this value should be decreased. But under dark condition, this value should be increased to get a good image quality. Increasing value may decrease frame rate. Finally, integration time is very important for frame rate and image quality.

For line mode exposure, register 26h and 27h are used. For pixel mode exposure, all three register 25h ~ 27h are used. To control exposure time precisely, the pixel mode should be used. This register may be used for Auto Exposure control.

(11) Operating Clock Divider (Address 28h, default:00h, R/W)

This register generates divided digital clock depending on the settings **clk_div** [3:0], digital block can divide MCLK down by 1 through 2048 as shown in Table 1.

clk_div[3:0]	units	clk_div[3:0]	units
0000	no division	0101	MCLK/64
0001	MCLK/2	0111	MCLK/128
0010	MCLK/4	1000	MCLK/256
0011	MCLK/8	1001	MCLK/512
0100	MCLK/16	1010	MCLK/1024
0101	MCLK/32	1011	MCLK/2048

Table 1. Operating Clock Control Register

(12) Reset Level Control Register (Address 30h, default:38h, R/W)

This register controls reference voltage level for start point of data reading. If the register value is too large or too small, the vertical Fixed Pattern Noise(FPN) can be occurred. To Get rid of FPN, this register must have a suitable value. Optimum reset level can be found using Low reference number registers 57h ~ 58h and High reference number registers 59h ~ 5ah. If there is some large value in Low reference number registers, the value of Reset Level control register should be increased. If there is some large value in High reference number registers, the value of register should be decrease. Optimum reset level is achieved when value of Low reference level number registers and value of High reference number registers is minimized.

(13) Color Gain Register

- Red Color Gain Register : (Address 31h, default : h1Eh, R/W)
- Green Color Gain Register : (Address 32h, default : h1Eh, R/W)
- Blue Color Gain Register : (Address 33h, default : h1Eh, R/W)

These registers are used to amplify the analog pixel output. If the gain register value is decreased, the amplification is increased. Therefore under the dark light source condition, the pixel output have to be amplified by decreasing gain value to get good image. There are three Gain registers to control RGB colors independently. In the case of monochrome image sensor, use only Green Color Gain Register. Available program range is 0 ~ 63 but too small value can cause FPN. The register value have to chosen within the range that doesn't cause FPN. Recommended range is 20 ~63. These register can be used for Auto White Balance control and Auto Exposure control.

This document is a general product description and is subject to change without notice. Hynix Semiconductor does not assume any responsibility for use of circuits described. NO patent licenses are implied.

(14) Pixel Bias Voltage Register (Address 34h, default:02h, R/W)

This register controls pixel reference level by controlling bias current of pixel output sensing load transistor. It controls pixel output level itself, compare with that level register adjust A/D Converter circuit to calibrate reference level for data reading. Available program range is 0 ~ 7. The larger register value causes the higher bias current and low pixel output reference level. This register is option for manufacturer. Users may use default setting and don't changed value.

(15) Low Reference Number Register(low_ref_no)

High : (Address 57h default : 00h, Read Only)

Low : (Address 58h, default : 00h, Read Only)

Low Reference Number Registers indicates number of pixels in frame that have a value less than 5. A reference level values of each pixel is compare with '5', and accumulated to these registers during read state. This counter value called **low_ref_no**, consist of two bytes and it is read only registers. Real number of pixels that have value less than 5 is the twice of these register value. If **low_ref_no** is big value, you must increase data value of Reset Level Control Register. These registers are updated after every VSYNC signal.

(16) High Reference Number Register (high_ref_no)

High : (Address 59h, default:00h, Read Only)

Low : (Address 5Ah, default:00h, Read Only)

High Reference Number Registers indicates number of pixels in a frame that have a value great then 123. Reference level values of each pixels is compared with '123', and accumulated to these registers during read state. This counter value called **high_ref_no**, consist of two bytes and it is read only registers. Real number of pixels that have value great than 123 is the twice of these register value. If **high_ref_no** is big value, you must decrease data value of Reset Level Control Register. These registers are also updated after every VSYNC signal.

FRAME TIMING DIAGRAMS

There are two frame timing cases,

- Integration Time < EffectiveWindowHeight * Scale
- Integration Time > EffectiveWindowHeight * Scale

EffectiveWindowHeight is equal to the number of data lines generated in a frame and is defined to be selected by

```
if((RowStartAddress + WindowHeight + 1) <= (SensorArrayHeight))
    EffectiveWindowHeight = WindowHeight;
else
    EffectiveWindowHeight = (SensorArrayHeight - RowStartAddress - 1);
```

For example, RowStartAddress = 200 and WindowHeight = 300, EffectiveWindowHeight is 113 and 113 data lines per a frame are generated.

Note : The above selection logic is somewhat confusing in respect of general counting measure. It's partly due to the mixed use of indexing start points, i.e. '0' and '1' in the design. Therefore in order to avoid the confusion it is desirable to just follows the equation when you estimate the frame rate.

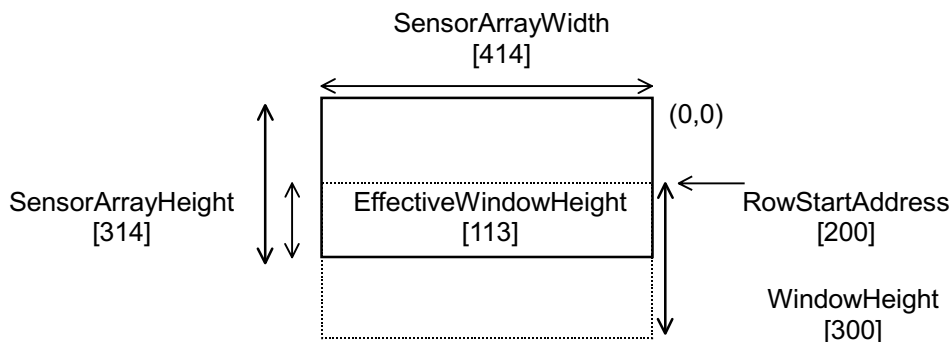

Scale is selected according to Integration Time Mode by

```
If(PixelMode)    Scale = SensorArrayWidth; // For400*300 resolution chip, SensorArrayWidth is 414
else              Scale = 1;
```

This document is a general product description and is subject to change without notice. Hynix Semiconductor does not assume any responsibility for use of circuits described. NO patent licenses are implied.

When $\text{Integration Time} > (\text{EffectiveWindowHeight} * \text{Scale})$, next frame VSYNC does not follow immediately after current frame's last line has been produced. Instead, one of the following two idle time slots is inserted according to Integration Time Mode before next frame VSYNC gets active.

< Idle Slots >

- Line Mode: $(\text{Integration Time} - \text{EffectiveWindowHeight}) * 1024$ clocks
- Pixel Mode: $(\text{Integration Time} - \text{EffectiveWindowHeight} * \text{Scale})$
 $= (\text{Integration Time} - \text{EffectiveWindowHeight} * \text{SensorArrayWidth})$ clocks

Each Frame Timing of the above cases may be decomposed into four timing segments

- Initial Data Setup Time after ENB gets active
- Even Line
- Odd Line
- Frame Transition

The subsections will describe frame timing diagram for said frame time cases, $(\text{Integration Time} < \text{Effective Window Height} * \text{Scale})$ and $(\text{Integration Time} > \text{Effective Window Height} * \text{Scale})$

(1) Frame Timing Diagram for Integration Time < (EffectiveWindowHeight * Scale)

Frame timing related registers are programmed to suit for the above condition as follows

```
RowStartAddress    = 6;      WindowHeight = 302;  
ColumnStartAddress = 6;      WindowWidth  = 402;  
IntegrationTime    = 200 [Line Mode];
```

EffectiveWindowHeight is "302" for $(\text{SensorArrayHeight} > (\text{RowStartAddress} + \text{WindowHeight} + 1))$, i.e. $314 > (6 + 302 + 1)$, is met, and Scale is "1" for integration time is line mode.

Therefore, $(\text{Integration Time} < \text{EffectiveWindowHeight} * \text{Scale})$, i.e. $200 < 302 * 1$, is met.

Overall Frames Sequence

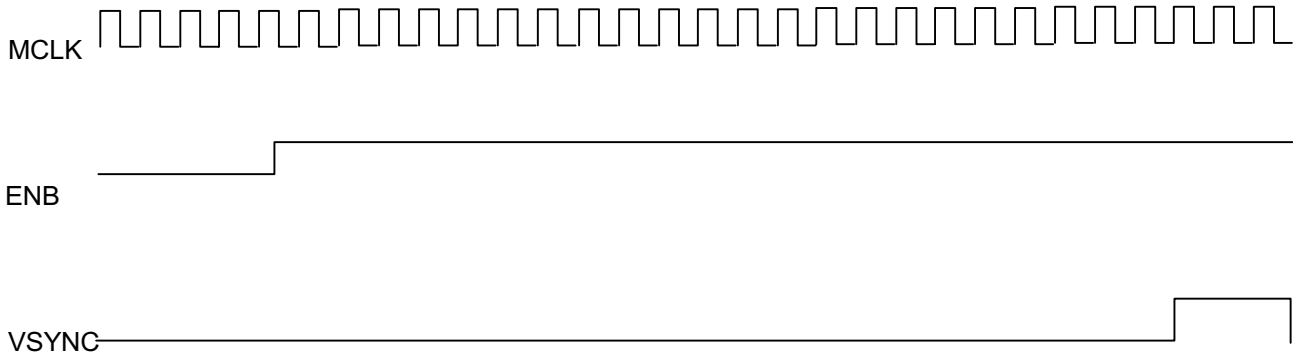
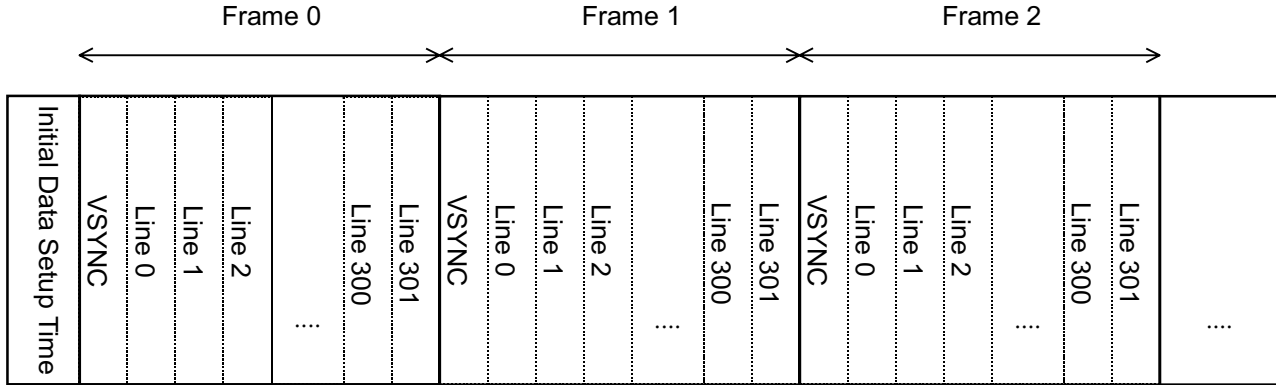

Delay Slots	ENB+ Deglitch 2 clocks	Sensor Reset SensorArrayHeight clocks [314 clocks]	Integration Time * Scale clocks [200 * 414 clocks]	One Line Time Delay (SensorArrayWidth + SensorArrayHeight) clocks	VSYNC 3 clocks
-------------	---------------------------	--	--	---	-------------------

Fig. 1 Initial Data Setup Time after ENB gets active

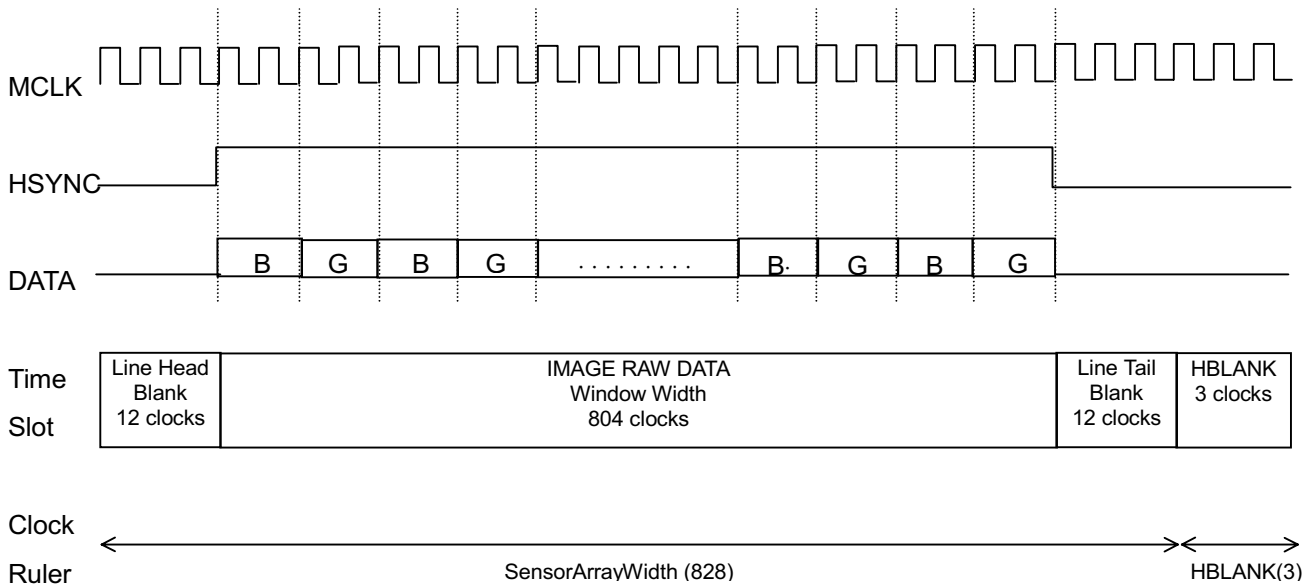

Fig.2 Even Line Data Timing

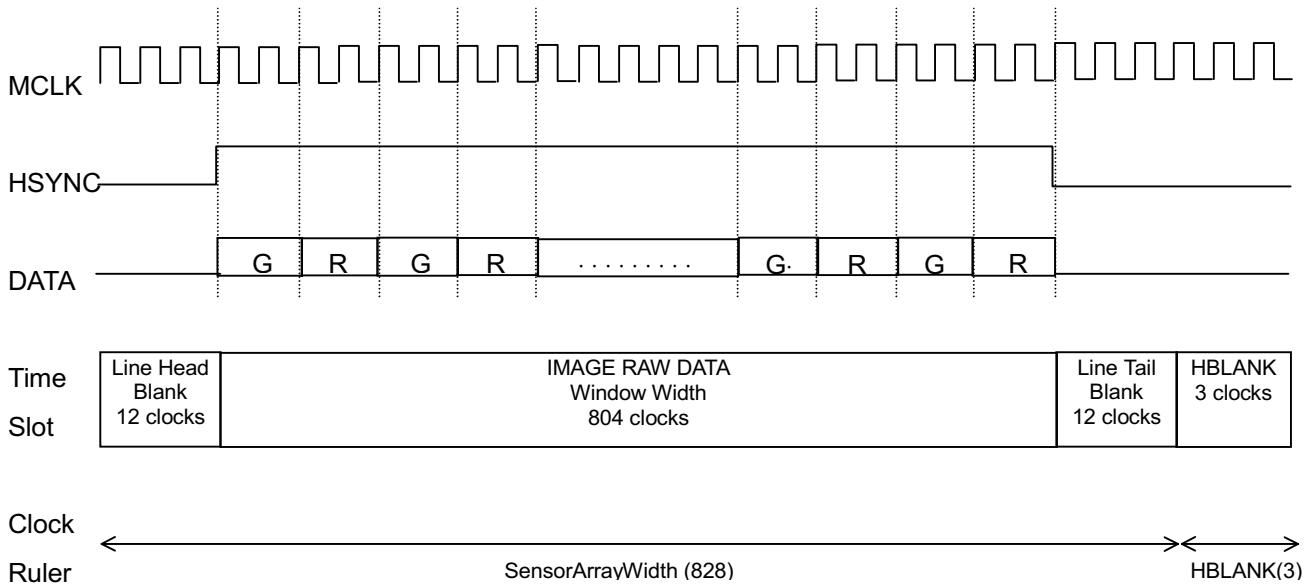
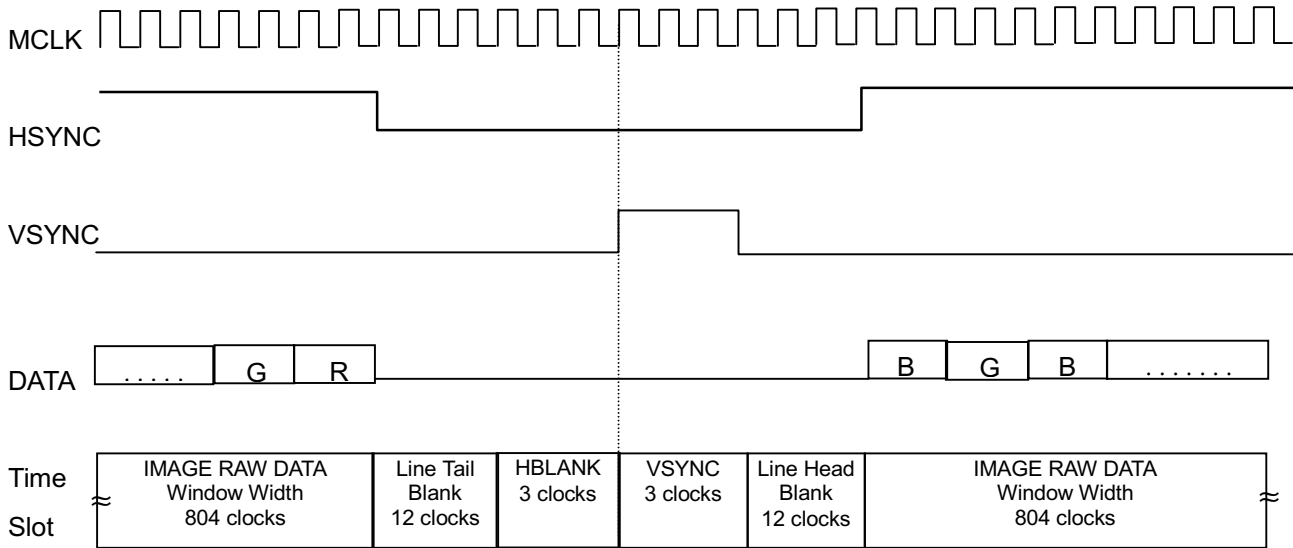

Fig.3 Odd Line Data Timing

This document is a general product description and is subject to change without notice. Hynix Semiconductor does not assume any responsibility for use of circuits described. NO patent licenses are implied.



$$\text{Integration Time} < \text{EffectiveWindowHeight} * \text{Scale}$$

Fig.4 Frame Transition Timing

(2) Frame Timing Diagram for Integration Time > (EffectiveWindowHeight * Scale)

Frame timing related registers are programmed to suit for the above condition as follows

RowStartAddress = 6; WindowHeight = 302;

ColumnStartAddress = 6; WindowWidth = 402;

IntegrationTime = 600 [Line Mode];

EffectiveWindowHeight is "302" for (SensorArrayHeight > (RowStartAddress + WindowHeight + 1)), i.e. 314 > (6 + 302 + 1), is met, and Scale is "1" for integration time is line mode. Therefore, (Integration Time < EffectiveWindowHeight * Scale), i.e. 600 > 302 * 1, is met, and Idle Slot of Line Mode, i.e. (600 - 302) * 1024 clocks idle slot, is inserted before the next frame initiation.

Overall Frames Sequence

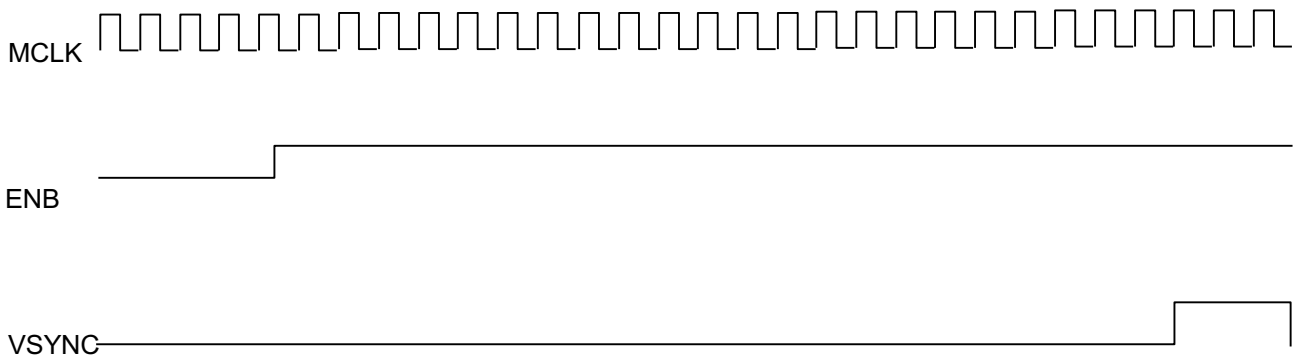
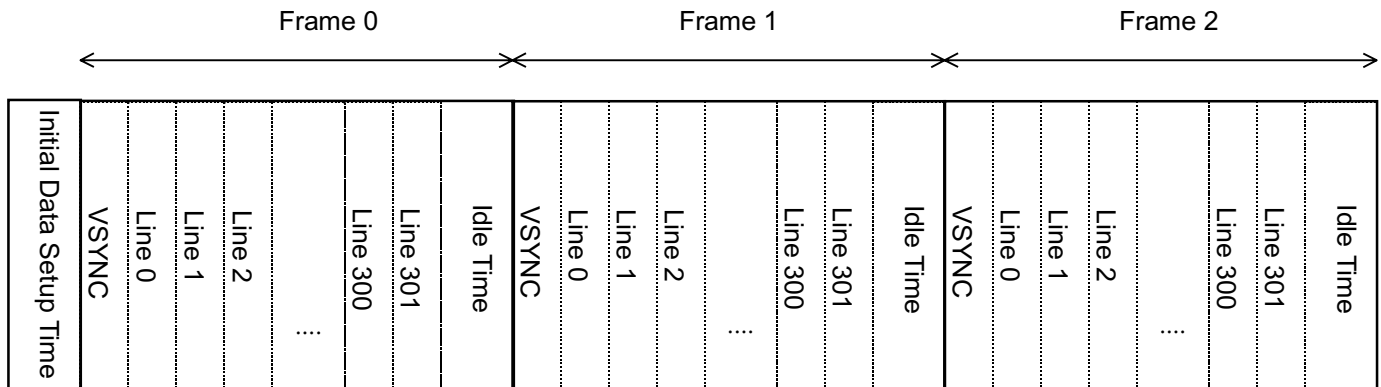

Delay Slots	ENB Deglitch 2 clocks	Sensor Reset SensorArrayHeight clocks [314 clocks]	Integration Time * Scale clocks [600 * 414 clocks]	One Line Time Delay (SensorArrayWidth + Line 0)	VSYNC 3 clocks
-------------	--------------------------	--	--	---	-------------------

Fig. 5 Initial Data Setup Time after ENB gets active

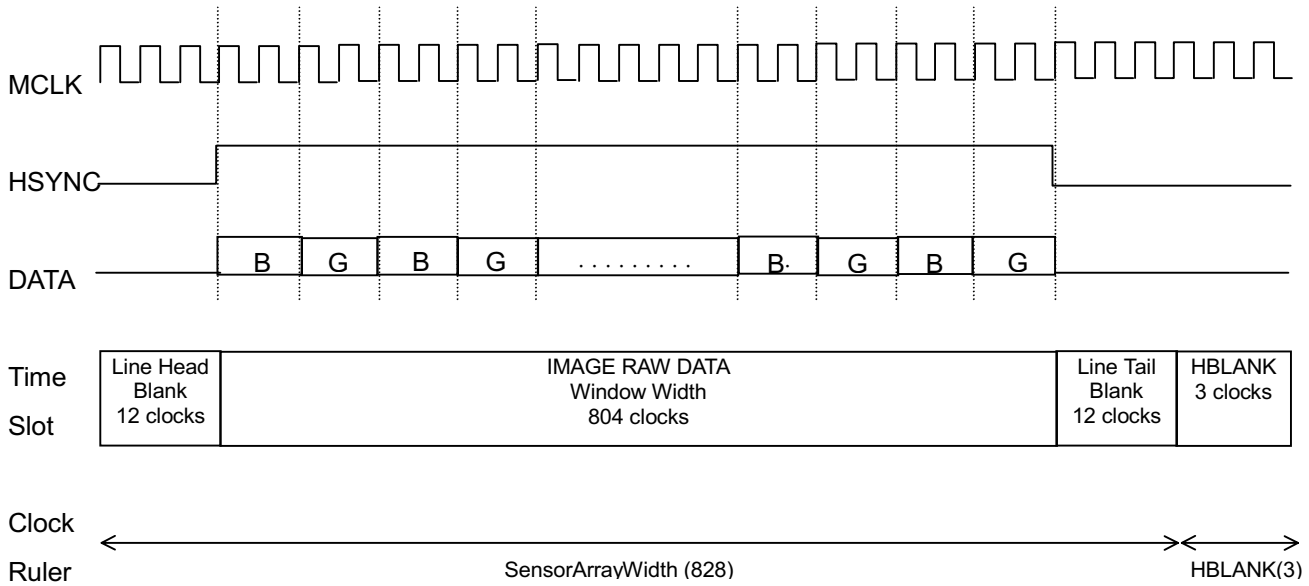

Fig.6 Even Line Data Timing

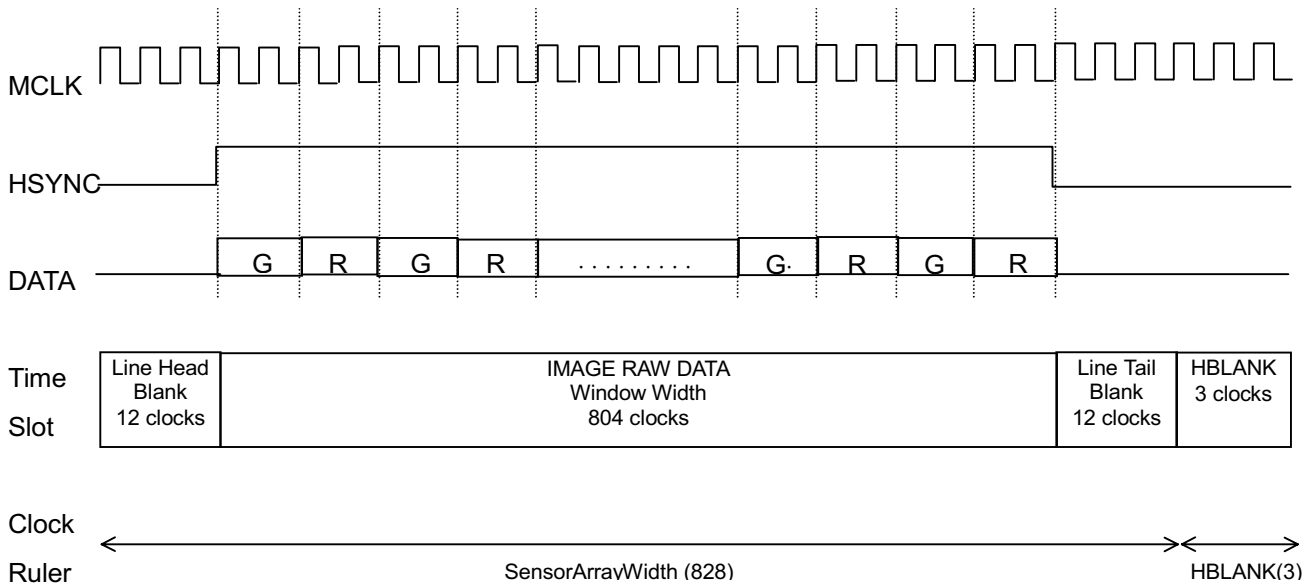
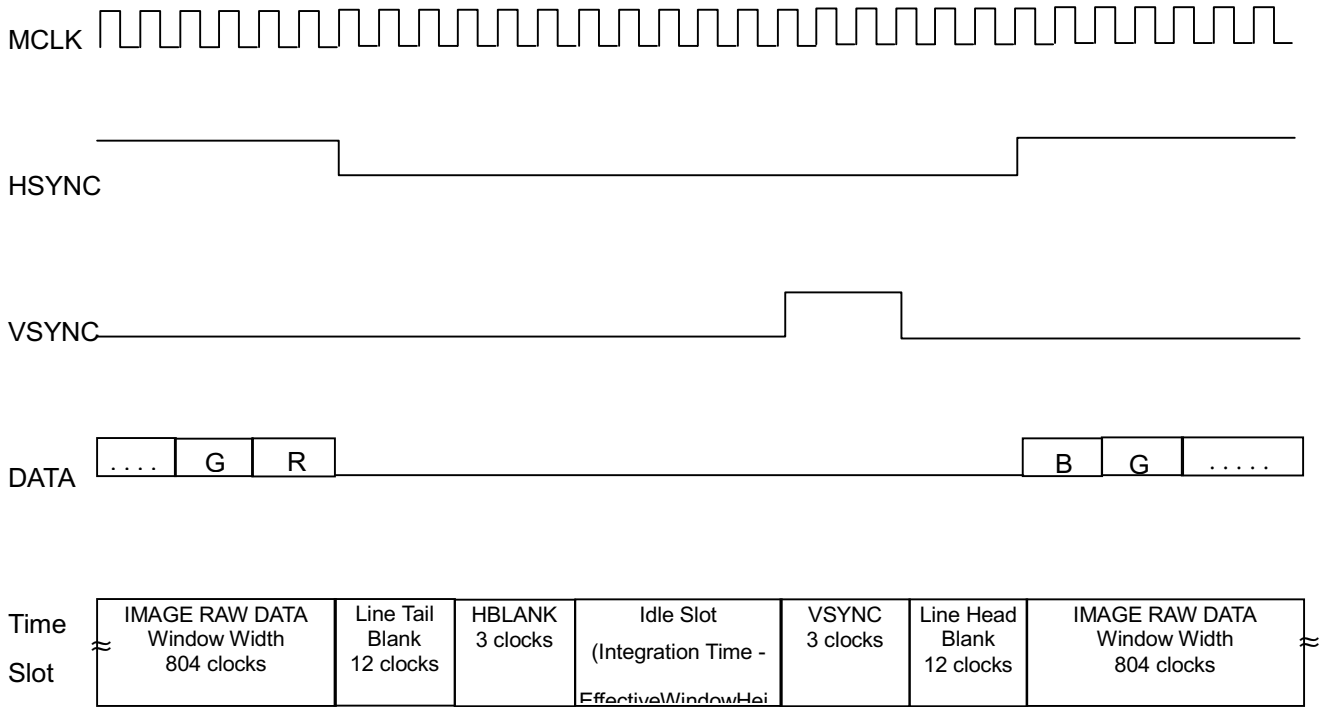

Fig.7 Odd Line Data Timing

This document is a general product description and is subject to change without notice. Hynix Semiconductor does not assume any responsibility for use of circuits described. NO patent licenses are implied.



$$\text{Integration Time} > \text{EffectiveWindowHeight} * \text{Scale}$$

Fig.8 Frame Transition Timing

PACKAGE DIMENSION (34 pin COB)

UNIT: mm

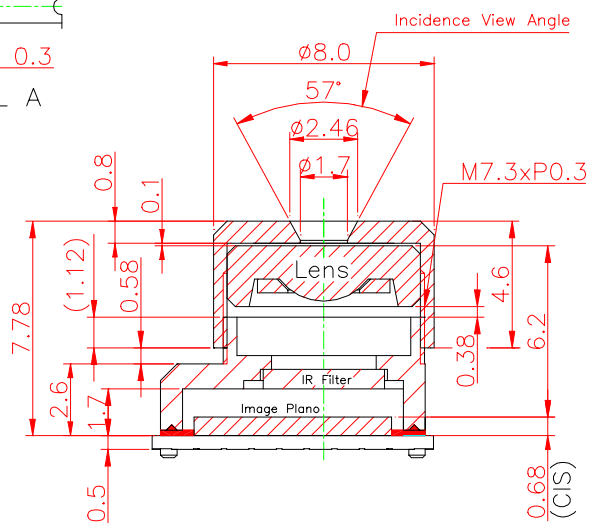
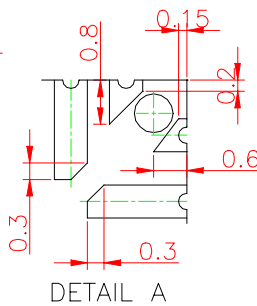
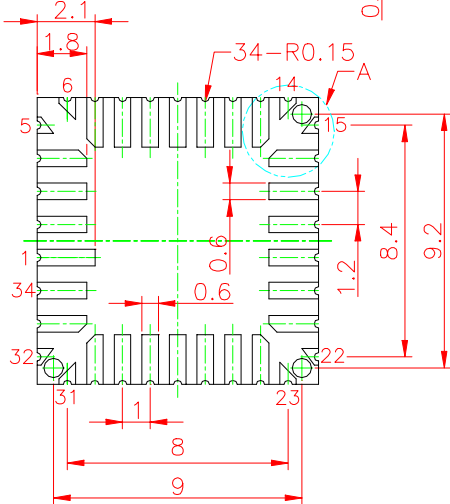
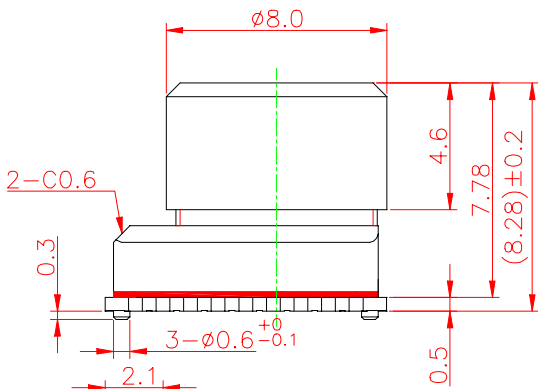
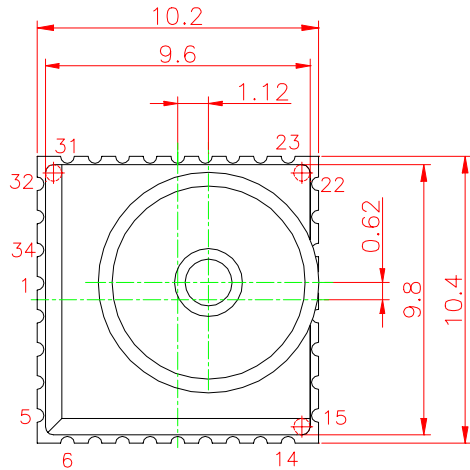

PIN NO	Description
1	AGND
2	AVDD
3-5	Reserved
6	DGND
7	DATA7
8	DATA6
9	DATA5
10	DATA4
11	DGND
12	DATA3
13	DATA2
14	DATA1
15	DATA0
16	DVDD
17	Reserved
18	DGND
19-20	DVDD
21	RESET
22	VSYNC
23	HSYNC
24	DGND
25	SDA
26	DGND
27	SCK
28	DGND
29	ENB
30	DGND
31	MCLK
32	VDD5
33	AVDD
34	AGND

Standard Tolerance : +/- 0.1, Unit : mm

This document is a general product description and is subject to change without notice. Hynix Semiconductor does not assume any responsibility for use of circuits described. NO patent licenses are implied.



Semiconductor Inc.
System IC SBU

HV7121B-COB
CMOS IMAGE SENSOR
With 8-bit ADC

MEMO

Hynix Semiconductor Inc.
System IC SBU

Headquarter & Factory

San 136-1,Ami-Ri,Bubal-Eub,Ichon-Si,Kyoungki-Do,Korea 467-701

Tel : 82-336-630-3835/2042, Fax : 82-336-630-2113, E-mail : kwangho@hei.co.kr

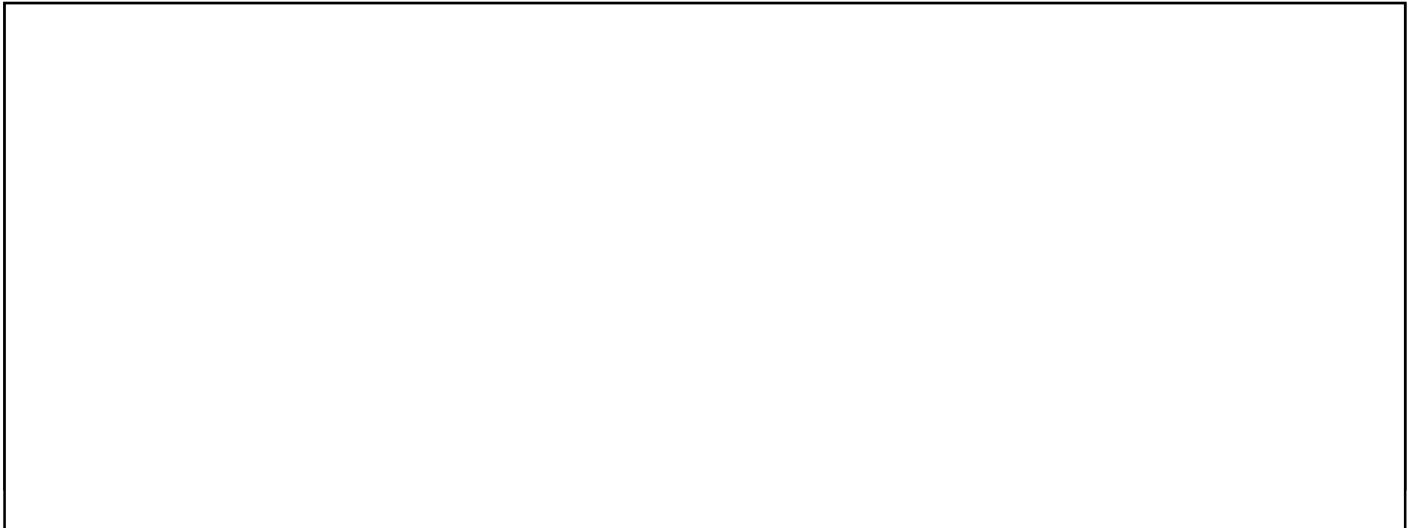

This document is a general product description and is subject to change without notice. Hynix Semiconductor does not assume any responsibility for use of circuits described. NO patent licenses are implied.