

Features

- **Low Insertion Loss:** 0.5 dB @ 2.5 GHz
- **Isolation:** 23 dB @ 2.5 GHz
- **Low DC Power Consumption**
- **Miniature USON6L (1.5x1.5x0.4 mm)**
Using Lead (Pb) free materials with RoHS compliant
- **PHEMT process**

USON6L (1.5X1.5X0.4 mm)

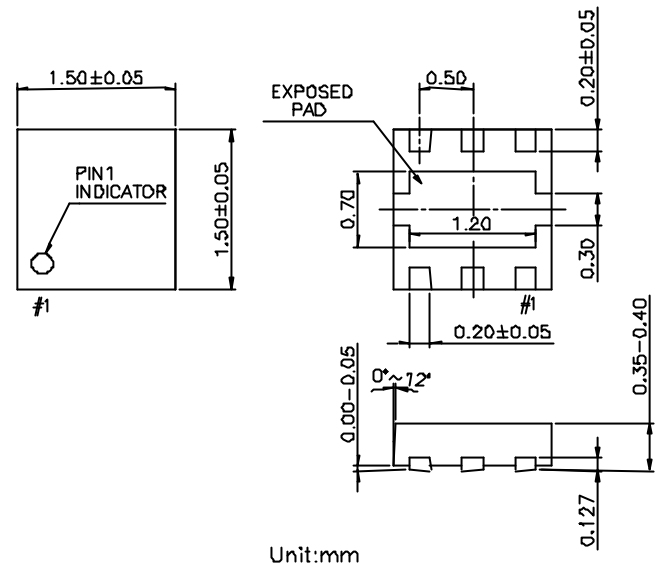

Description

The HWS516 is a GaAs PHEMT MMIC SPDT switch with 50 Ω termination operating at 0.5-3.0 GHz in a low cost miniature USON6L (1.5x1.5x0.4 mm) plastic lead (Pb) free package. The HWS516 features low insertion loss and high isolation with very low DC power consumption. This switch can be used in Bluetooth or IEEE 802.11b/g/n WLAN applications as transmit/receive switch, antenna diversity switch, or band-selection switch.

Electrical Specifications at 25°C with 0, +3V Control Voltages

Parameter	Test Conditions	Min.	Typ.	Max.	Unit
Insertion Loss	0.5-1.0 GHz		0.35	0.55	dB
	1.0-2.0 GHz		0.40	0.60	dB
	2.0-2.5 GHz		0.45	0.65	dB
	2.5-3.0 GHz		0.50	0.70	dB
Isolation	0.5-2.0 GHz	22	24		dB
	2.0-2.5 GHz	21	23		dB
	2.5-3.0 GHz	20	22		dB
Input(Output) Return Loss	0.5-3.0 GHz	15	20		dB
Unused Port Return Loss	2.0-2.4 GHz		13		dB
	2.4-2.5 GHz		15		dB
	2.5-3.0 GHz		17		dB
Input Power for One dB Compression	0.5-3.0 GHz @ 0/+3V	27	31		dBm
2 nd & 3 rd Harmonics	20 dBm @2.5GHz		70		dBc
Switching Time			300		ns
Control Current			5	20	uA

Note: All measurements made in a 50 Ohm system with 0/+3V control voltages, unless otherwise specified.

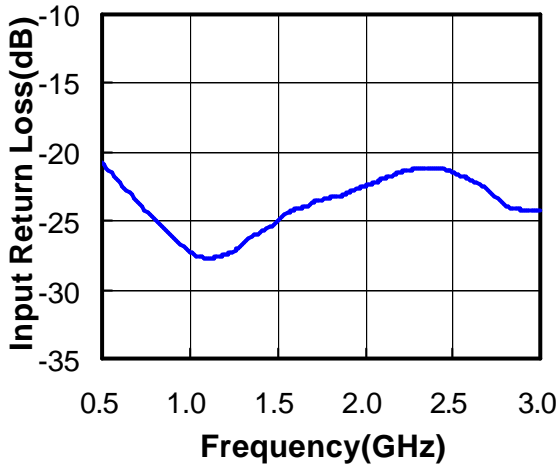
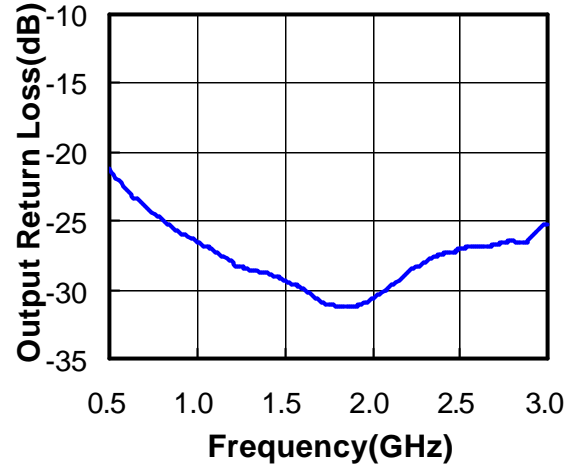
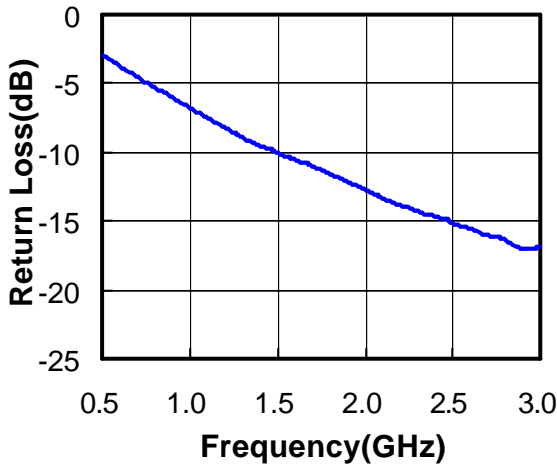
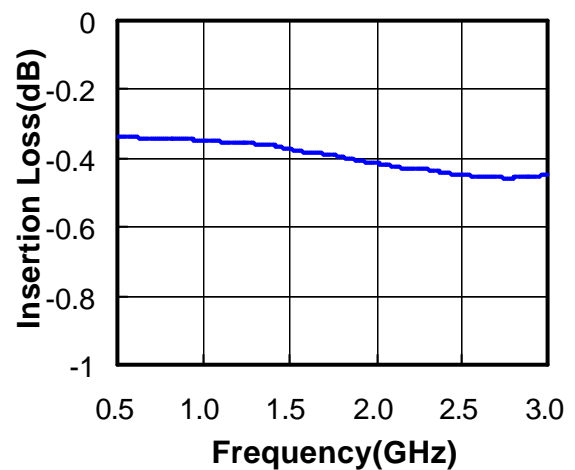
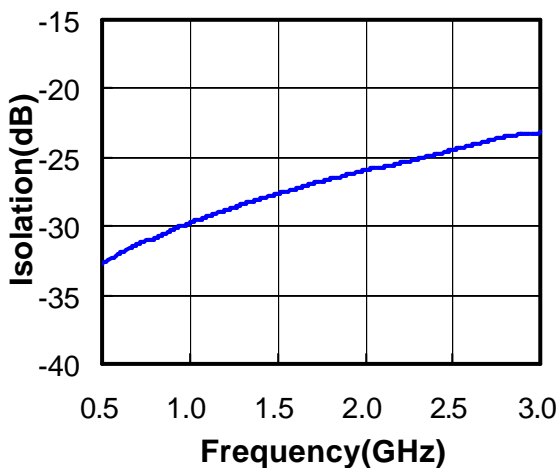
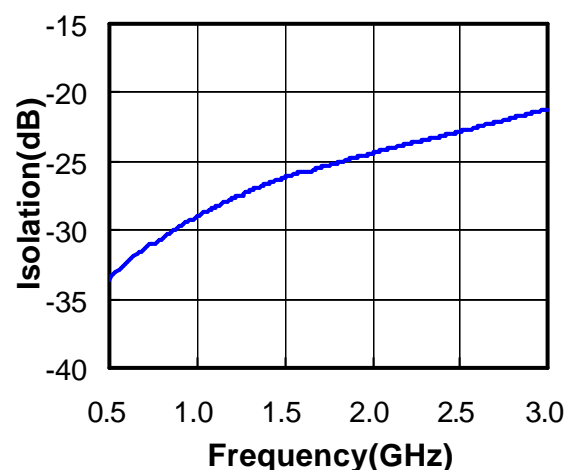
Typical Performance Data with 47pF Capacitors @ +25°C
**Input(RFC)
Return Loss vs. Frequency**

**Output(RF1/RF2)
Return Loss vs. Frequency**

**Unused Port(RF1/RF2)
Return Loss vs. Frequency**

**RFC RF1/RF2
Insertion Loss vs. Frequency**

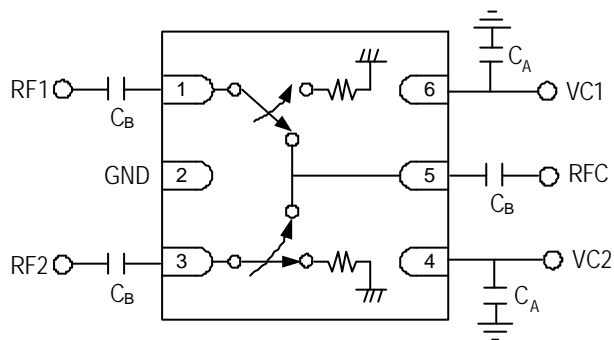
**RFC RF1/RF2
Isolation vs. Frequency**

**RF1 RF2
Isolation vs. Frequency**

Absolute Maximum Ratings

Parameter	Absolute Maximum
RF Input Power 0.5-3.0 GHz	+33dBm
Control Voltage	+6V
Operating Temperature	-40°C to +85°C
Storage Temperature	-65°C to +150°C
Electrostatic Discharge Machine Model	Class M1

Pin Out (Top View)



Note:

DC blocking capacitors C_B are required on all RF ports.

$C_B=C_A=47\text{pF}$ for operating frequency > 500MHz.

Logic Table for Switch On-Path

VC1	VC2	RFC-RF1	RFC-RF2
1	0	On	Off
0	1	Off	On

'1' = +2.7V to +5V

'0' = 0V to +0.2V