



DATA SHEET

(DOC No. HX8615B-DS)

HX8615B

240 Channel TFT Gate Driver

Version 04 May, 2005

Himax Technologies, Inc.

<http://www.himax.com.tw>

www.DataSheet4U.com

HX8615B

240 Channel TFT Gate Driver



Himax Technologies, Inc.

<http://www.himax.com.tw>

Version 04

May, 2005

1. General Description

The HX8615B is a 240 channel outputs gate driver used for driving the gate electrode of TFT LCD panel. It is designed for 2-level output with maximum +40V output driving voltage. This device is applicable for a wide range of panel resolution including VGA and UXGA.

2. Features

- 2-level output gate driver for TFT LCD panel
- 240 channel outputs + 2 pins fixed to VEE
- Maximum +40V output driving voltage
- Bi-directional data shift capability
- 200KHz maximum operation frequency
- 2.7V to 5.5V power supply voltage range
- High voltage CMOS process technology
- COG package
- Possible applications:

Panel type	Resolution	Piece per panel
VGA	640 × 480	2
UXGA	1600 × 1200	5
	1920 × 1440	6

3. Block Diagram

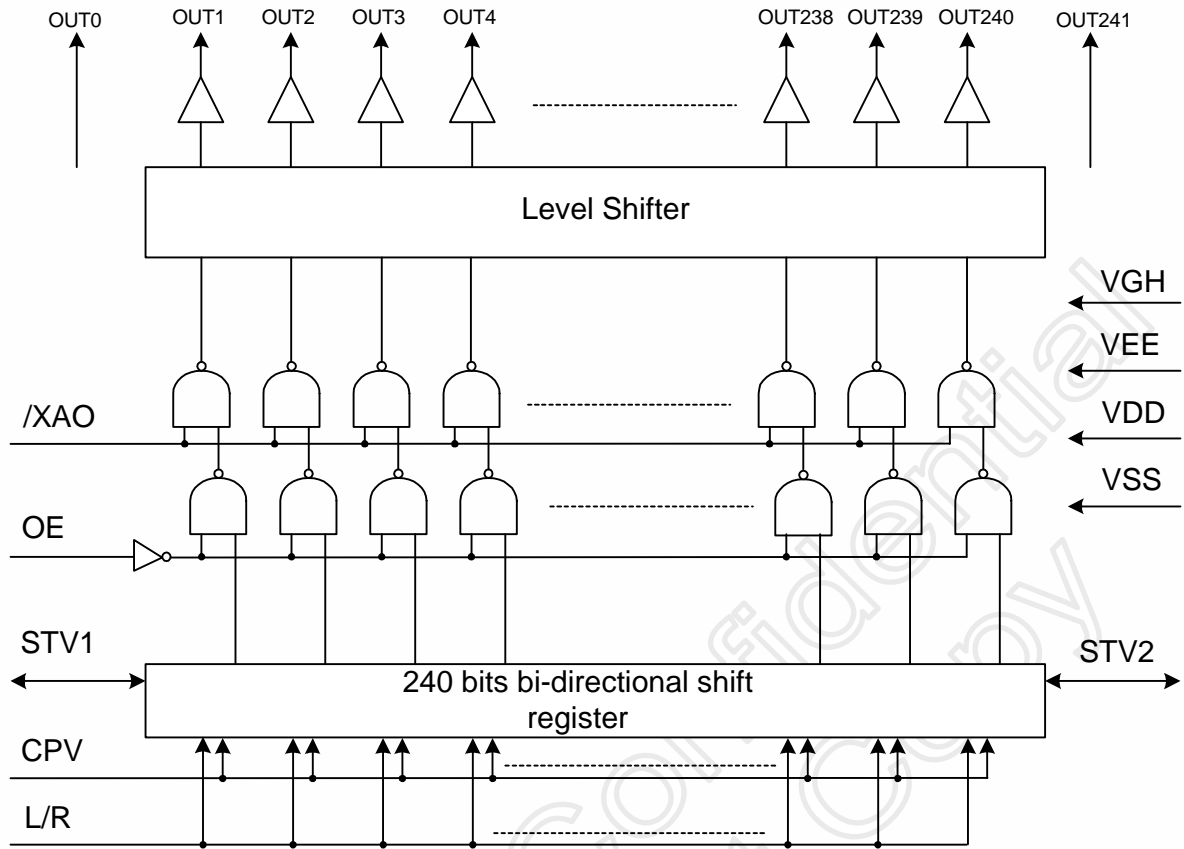

4. Pin Description

Pin name	I/O	Function	Description									
CPV	In	Shift clock input	This is the clock input for chip internal shift register. Data is shifted at each rising edge of this clock.									
L/R	In	Shift direction control pin	This pin controls the output shifting direction as listed below. L/R = H, STV1 → OUT1 → OUT2 → ... → OUT240 → STV2 L/R = L, STV1 ← OUT1 ← OUT2 ← ... ← OUT240 ← STV2									
STV1 STV2	I/O	Start pulse Input/output pin	These two pins are the device start pulse input or output pin. The function of these two pins depends on the status of L/R pin. <table border="1" data-bbox="655 669 1342 779"> <thead> <tr> <th></th> <th>STV1</th> <th>STV2</th> </tr> </thead> <tbody> <tr> <td>L/R=H</td> <td>input</td> <td>output</td> </tr> <tr> <td>L/R=L</td> <td>output</td> <td>input</td> </tr> </tbody> </table>		STV1	STV2	L/R=H	input	output	L/R=L	output	input
	STV1	STV2										
L/R=H	input	output										
L/R=L	output	input										
OE	In	Output enable control	This pin is used to control the channel output. When OE input is H, driver output is fixed to VEE regardless CPV. However, the internal shift register is not cleared even if OE input is inactive.									
/XAO	In	Output all high	When /XAO input pin is L, all the output pins are forced to VGH level. Note that this pin has higher priority than OE. Also it has an internal pull high resistor, keep it to VDD is preferred when unused. The chip internal shift register is not cleared when /XAO input is active.									
OUT1 ~ OUT240	Out	Driver output pins for driving gate electrode of LCD	The output voltage is either VGH or VEE for driving the gate electrode of TFT LCD panel depending on the data stored in shift register and the state of OE.									
OUT0, OUT241	Out	Auxiliary pins	LCD panel auxiliary pins, these pins always output VEE level.									
VGH	In	Power supply	Power supply for LCM drive output High									
VDD	In	Power supply	Digital power									
VSS	In	Power supply	Digital ground									
VEE	In	Power supply	LCD driver negative power supply									
PATH	-	-	Linked together internal.									

5. Function Description

5.1 Device operation

In the condition of L/R=H, the STV1 start pulse input is sensed at the rising edge of CPV and stored in the first stage of shift register, which causes the first scan signal is outputted from the OUT1 output pin. While stored data is transferred to the next stage shift register at the rising edge of next CPV, new data of STV1 is sensed and stored simultaneously.

The output pin (OUT1 to OUT240) supplies VGH voltage or VEE voltage to the LCD panel depending on the data stored in the shift register. For normal operation, a VGH voltage is outputted one by one from OUT1 to OUT240 in sync with CPV pulse.

After 240 CPV rising edge are past, the STV2 goes up to high level at the 240th falling edge of CPV and goes down to low level at the 241th falling edge of CPV. This STV2 output signal becomes the STV1 start pulse input of next cascaded gate driver device.

During any H state of OE, the corresponding output channels are forced to VEE regardless of CPV. The channel output returns to normal status as soon as OE goes back to L.

During any L state of /XAO, all the output channels are forced to VGH regardless of CPV and OE. The channel output returns to normal status as soon as /XAO goes back to H.

Example of input/output timing (L/R=H)

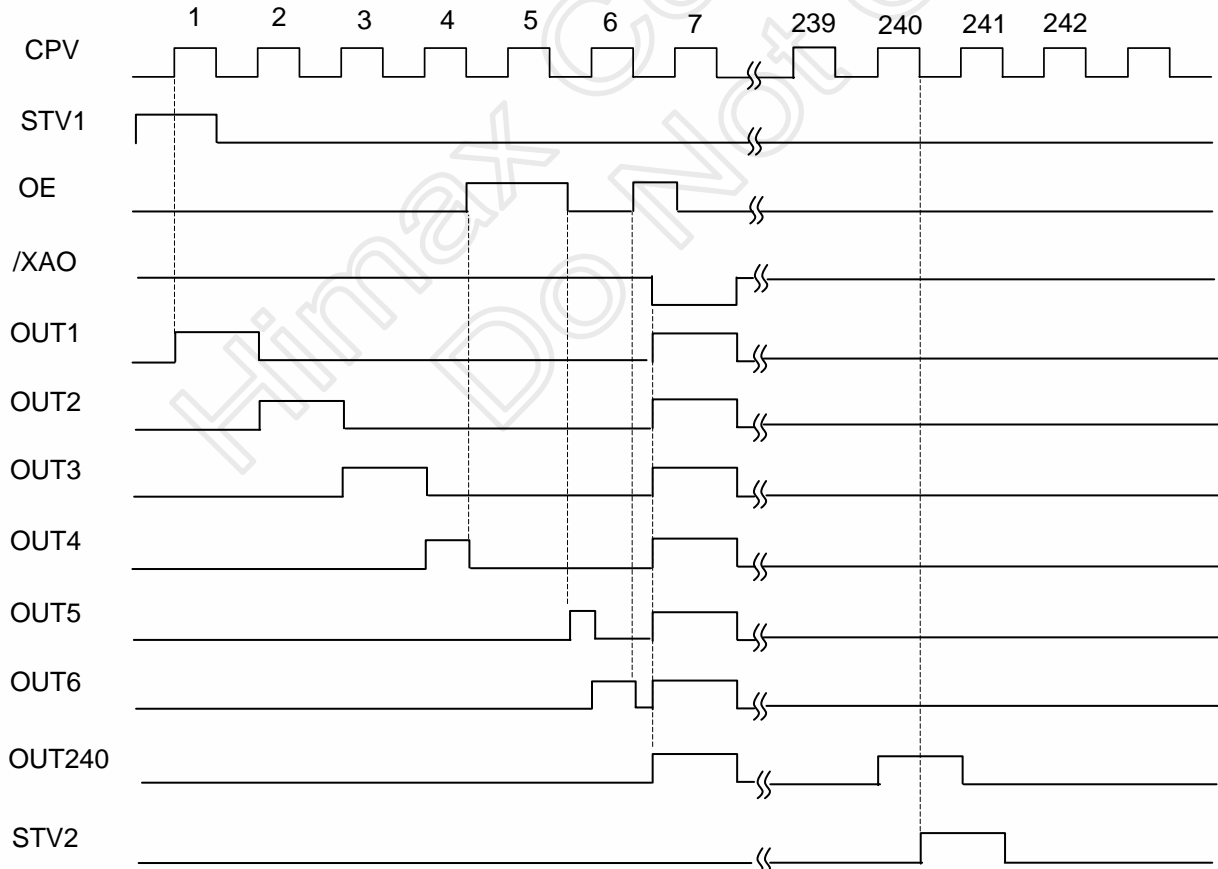

5.2 Relationship among L/R, and STV1/STV2

L/R	Start pulse		Data transfer direction
	Input	Output	
H	STV1	STV2	OUT1→OUT2→OUT3→ . . . →OUT240
L	STV2	STV1	OUT240→OUT239→OUT238→ . . . →OUT1

5.3 Device power supply

The HX8615B must be used by the following conditions.

- $V_{GH} - V_{EE} = 40V$ (max.)
- $V_{GH} - V_{SS} = 10 \sim 30V$

Example:

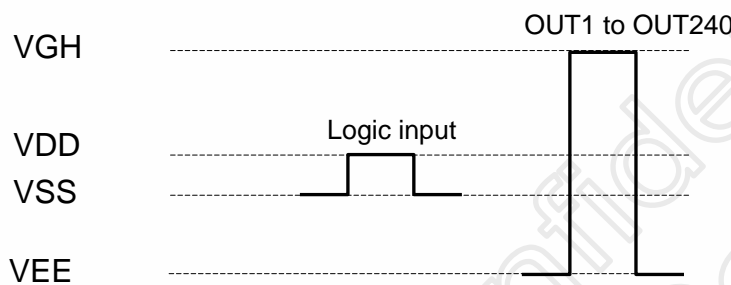

The input signal level of CPV, L/R, OE, STV1, /XAO and STV2 have to swing between VDD and VSS. The signal output level of start pulse (STV1 or STV2) to the next stage cascaded device is VDD for H and VSS for L.

5.4 Power ON/OFF sequence

To prevent the device from latch up, the power ON/OFF sequence shown below must be followed.

- When power on: $V_{DD} \rightarrow V_{EE} \rightarrow V_{GH}$
- When power off: $V_{GH} \rightarrow V_{EE} \rightarrow V_{DD}$

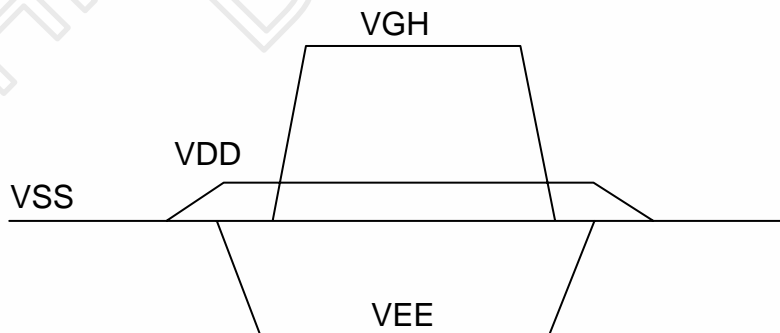

6. DC Characteristics

6.1 Absolute Maximum Rating (VSS=0V)

Parameter	Symbol	Rating			Unit
Power supply voltage (1)	VDD	-0.3	to	+7.0	V
Power supply voltage (2)	VGH	-0.3	to	+32.0	V
Power supply voltage (3)	VEE	-22.0	to	+0.3	V
Power supply voltage (4)	VGH-VEE	-0.3	to	+45.0	V
Input voltage	V _{in}	-0.3	to	VDD+0.3	V
Operation temperature	T _{OPR}	-40	to	+85	°C
Storage temperature	T _{STG}	-55	to	+125	°C

Note:

(1) All of the voltages listed above are with respect to VSS=0V.

(2) Device is subject to be damaged permanently if stresses beyond those absolute maximum ratings listed above.

6.2 Recommended Operating Conditions (VSS=0V)

Parameter	Symbol	Rating			Unit
		Min.	Typ.	Max.	
Power supply voltage (1)	VDD	2.7	3.3	5.5	V
Power supply voltage (2)	VGH	7	-	VEE+40	V
Power supply voltage (3)	VEE	-20	-	-5	V
Power supply voltage (4)	VGH-VEE	12	-	40	V
Power supply voltage (5)	VDD-VEE	6	-	-	V
Operation frequency	F _{CPV}	-	-	200	KHz
Operation temperature	T _a	-40	-	+85	°C

6.3 DC Electrical Characteristics (VSS=0V)

Parameter	Symbol	Condition	Rating			Unit	Application pin
			Min.	Typ.	Max.		
Input H voltage	V_{IH}	-	$0.7 \times VDD$	-	VDD	V	All input
Input L voltage	V_{IL}	-	VSS	-	$0.3 \times VDD$		All input
Output H voltage	V_{OH}	$I_{OH}=200\mu A$	$VDD-0.3$	-	VDD		STV1,2
Output L voltage	V_{OL}	$I_{OL}=200\mu A$	VSS	-	$VSS+0.3$		STV1,2
Output H resistance	R_{OH}	$V_{OUT} = VGH-0.5V$	-	-	1000	Ω	OUT1 ~ OUT240
Output L resistance	R_{OL}	$V_{OUT} = VEE+0.5V$	-	-	1000	Ω	OUT1 ~ OUT240
Pull high resistance	R_{XAO}	-	30	-	200	k Ω	/XAO
Input leakage current	I_{IN}	-	-1.0	-	+1.0	μA	Except /XAO pin
VGH Power consumption	I_{VGH}	Note ⁽¹⁾	-	-	100	μA	-
VEE Power consumption	I_{VEE}		-	-	-100		-
VDD Power consumption	I_{VDD}		-	-	50		-

Note:

(1) Power consumption with the following condition:
Output no load, VDD=3.3V, $F_{CPV}=20KHz$, $OE = V_{IL}$.

7. AC Characteristics

Parameter	Symbol	Condition	Spec			Unit
			Min.	Typ.	Max.	
CPV period	t_{CPV}	-	5	-	-	μs
CPV pulse width	t_{CPVH}, t_{CPVL}	50% duty cycle	2.5	-	-	
OE pulse width	t_{WOE}	-	1	-	-	
Data setup time	t_{SU}	-	0.2	-	-	
Data hold time	t_{HD}	-	0.3	-	-	
CPV to output delay time	t_{PD1}	CL=220pF	-	-	0.9	
Start pulse output delay time	t_{PD2}	CL=20pF	-	-	0.5	
OE to output delay time	t_{PD3}	CL=220pF	-	-	0.8	
/XAO to output delay time	t_{PD4}	CL=220pF	-	-	10	

Note:

(1) Test condition: TA=25°C, VGH=25V, VEE=-15V, VDD=3.3V

8. Waveform

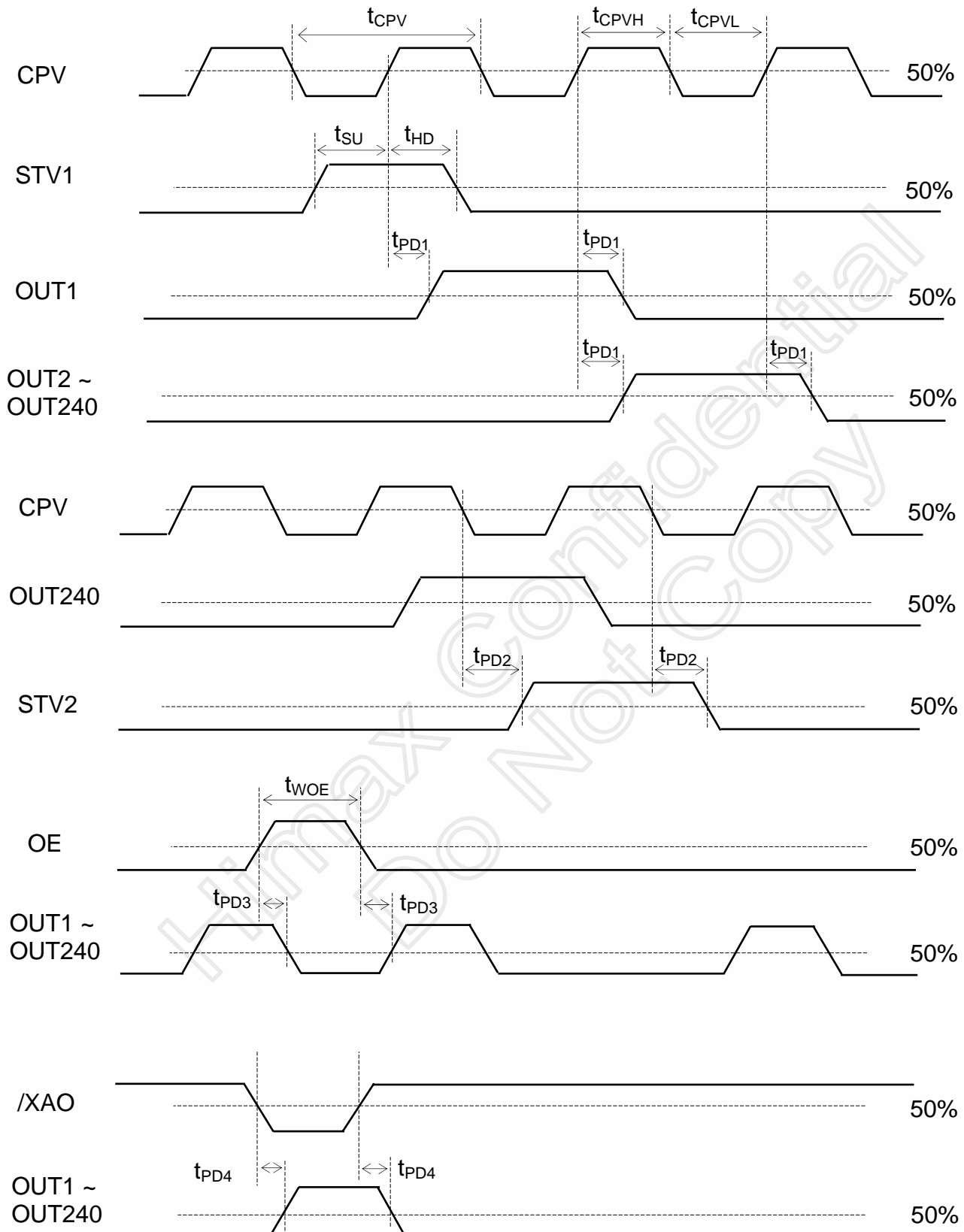

9. Pad Coordinate

9.1 HX8615B 240 channels Gate Driver for COG

Bump Location

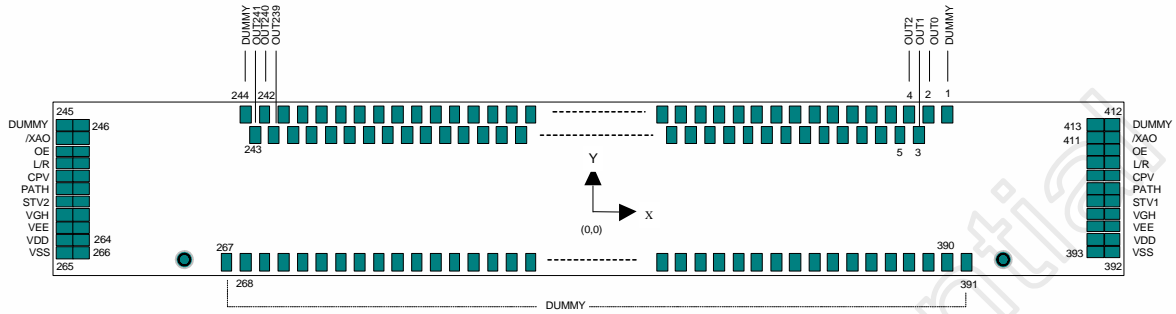

Chip size: 12090µm x 997.6µm (scribe line included)

Bump height: 15µm ± 3µm

Bump hardness: 60Hv ±15Hv

Scribe line width: 100µm

9.2 Bump Outline Dimensions

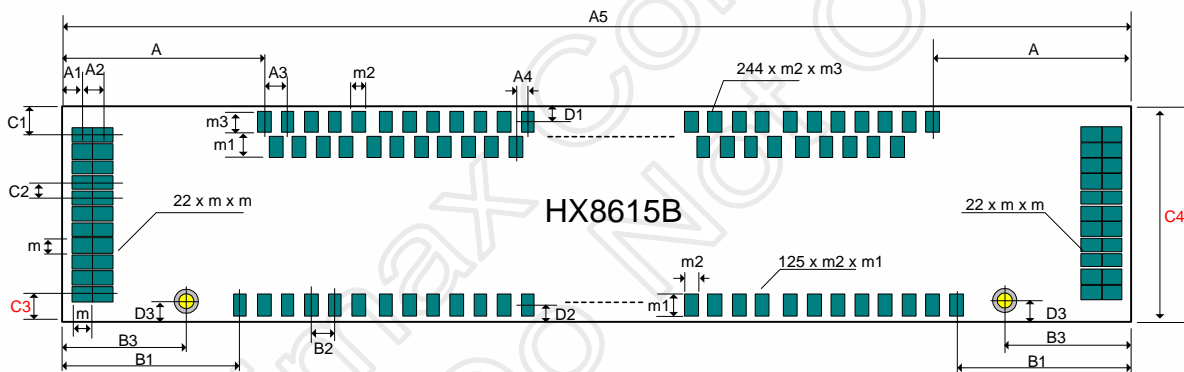

Symbol	Dimensions in µm	Symbol	Dimensions in µm
A	555	C2	75
A1	100	C3	142.6
A2	65	C4	997.6
A3	90	D1	105
A4	45	D2	117.6
A5	12090	D3	127.6
B1	465	m	50
B2	90	m1	85
B3	323	m2	45
C1	105	M3	60

9.3 Bump size

Top Bump

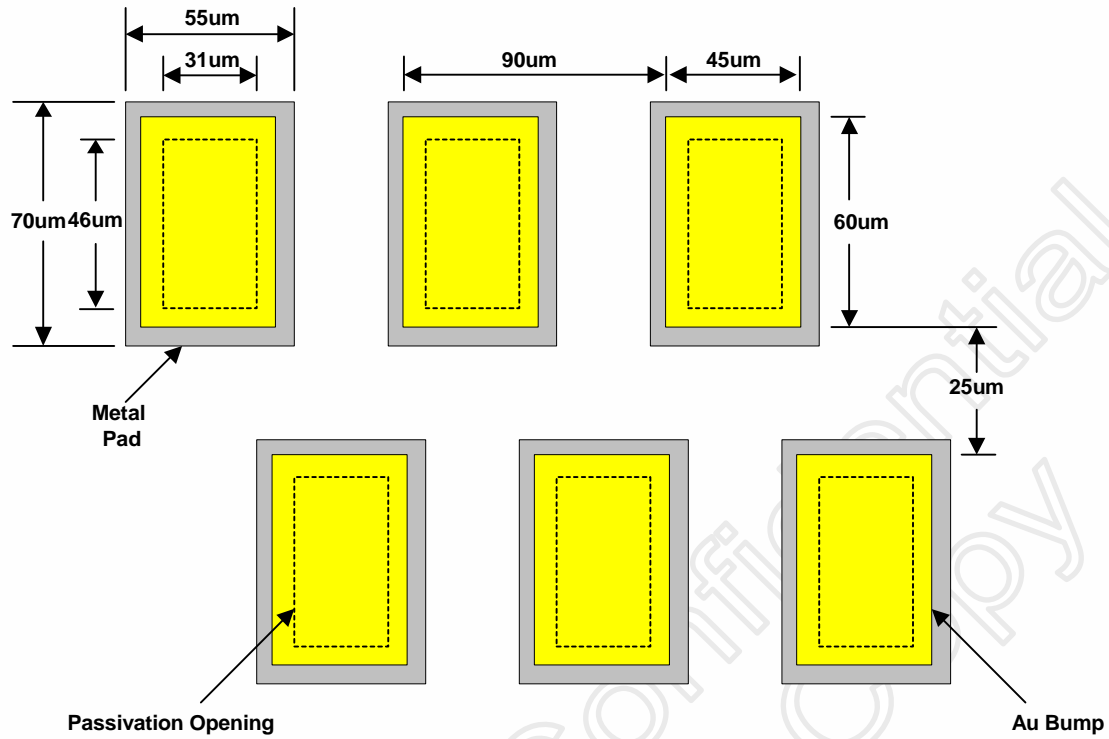

Bottom Bump

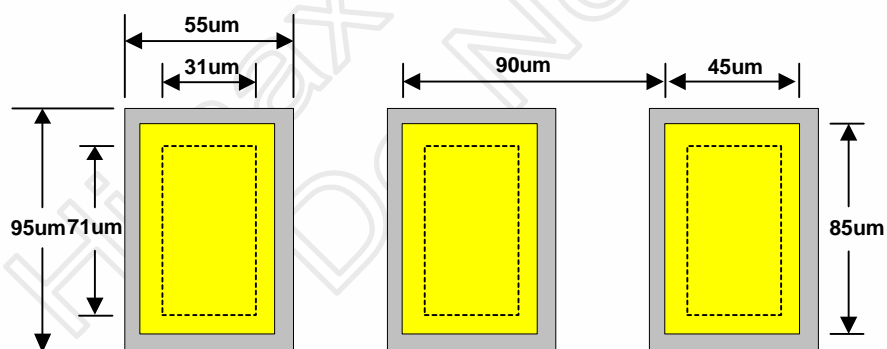

Side Bump

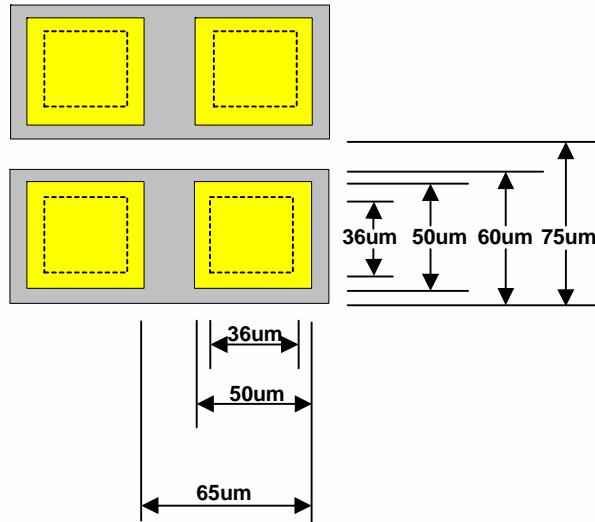

Alignment Mark

Left side & Right side

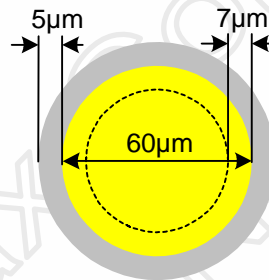

9.4 Bump center coordinate

(Unit: μm)

No.	Name	X	Y	Bump size
1	DUMMY	5490	375	45x60
2	OUT0	5400	375	45x60
3	OUT1	5355	290	45x60
4	OUT2	5310	375	45x60
5	OUT3	5265	290	45x60
6	OUT4	5220	375	45x60
7	OUT5	5175	290	45x60
8	OUT6	5130	375	45x60
9	OUT7	5085	290	45x60
10	OUT8	5040	375	45x60
11	OUT9	4995	290	45x60
12	OUT10	4950	375	45x60
13	OUT11	4905	290	45x60
14	OUT12	4860	375	45x60
15	OUT13	4815	290	45x60
16	OUT14	4770	375	45x60
17	OUT15	4725	290	45x60
18	OUT16	4680	375	45x60
19	OUT17	4635	290	45x60
20	OUT18	4590	375	45x60
21	OUT19	4545	290	45x60
22	OUT20	4500	375	45x60
23	OUT21	4455	290	45x60
24	OUT22	4410	375	45x60
25	OUT23	4365	290	45x60
26	OUT24	4320	375	45x60
27	OUT25	4275	290	45x60
28	OUT26	4230	375	45x60
29	OUT27	4185	290	45x60
30	OUT28	4140	375	45x60
31	OUT29	4095	290	45x60
32	OUT30	4050	375	45x60
33	OUT31	4005	290	45x60
34	OUT32	3960	375	45x60
35	OUT33	3915	290	45x60
36	OUT34	3870	375	45x60
37	OUT35	3825	290	45x60
38	OUT36	3780	375	45x60
39	OUT37	3735	290	45x60
40	OUT38	3690	375	45x60
41	OUT39	3645	290	45x60
42	OUT40	3600	375	45x60
43	OUT41	3555	290	45x60
44	OUT42	3510	375	45x60
45	OUT43	3465	290	45x60
46	OUT44	3420	375	45x60
47	OUT45	3375	290	45x60
48	OUT46	3330	375	45x60
49	OUT47	3285	290	45x60
50	OUT48	3240	375	45x60

No.	Name	X	Y	Bump size
51	OUT49	3195	290	45x60
52	OUT50	3150	375	45x60
53	OUT51	3105	290	45x60
54	OUT52	3060	375	45x60
55	OUT53	3015	290	45x60
56	OUT54	2970	375	45x60
57	OUT55	2925	290	45x60
58	OUT56	2880	375	45x60
59	OUT57	2835	290	45x60
60	OUT58	2790	375	45x60
61	OUT59	2745	290	45x60
62	OUT60	2700	375	45x60
63	OUT61	2655	290	45x60
64	OUT62	2610	375	45x60
65	OUT63	2565	290	45x60
66	OUT64	2520	375	45x60
67	OUT65	2475	290	45x60
68	OUT66	2430	375	45x60
69	OUT67	2385	290	45x60
70	OUT68	2340	375	45x60
71	OUT69	2295	290	45x60
72	OUT70	2250	375	45x60
73	OUT71	2205	290	45x60
74	OUT72	2160	375	45x60
75	OUT73	2115	290	45x60
76	OUT74	2070	375	45x60
77	OUT75	2025	290	45x60
78	OUT76	1980	375	45x60
79	OUT77	1935	290	45x60
80	OUT78	1890	375	45x60
81	OUT79	1845	290	45x60
82	OUT80	1800	375	45x60
83	OUT81	1755	290	45x60
84	OUT82	1710	375	45x60
85	OUT83	1665	290	45x60
86	OUT84	1620	375	45x60
87	OUT85	1575	290	45x60
88	OUT86	1530	375	45x60
89	OUT87	1485	290	45x60
90	OUT88	1440	375	45x60
91	OUT89	1395	290	45x60
92	OUT90	1350	375	45x60
93	OUT91	1305	290	45x60
94	OUT92	1260	375	45x60
95	OUT93	1215	290	45x60
96	OUT94	1170	375	45x60
97	OUT95	1125	290	45x60
98	OUT96	1080	375	45x60
99	OUT97	1035	290	45x60
100	OUT98	990	375	45x60

No.	Name	X	Y	Bump size
101	OUT99	945	290	45x60
102	OUT100	900	375	45x60
103	OUT101	855	290	45x60
104	OUT102	810	375	45x60
105	OUT103	765	290	45x60
106	OUT104	720	375	45x60
107	OUT105	675	290	45x60
108	OUT106	630	375	45x60
109	OUT107	585	290	45x60
110	OUT108	540	375	45x60
111	OUT109	495	290	45x60
112	OUT110	450	375	45x60
113	OUT111	405	290	45x60
114	OUT112	360	375	45x60
115	OUT113	315	290	45x60
116	OUT114	270	375	45x60
117	OUT115	225	290	45x60
118	OUT116	180	375	45x60
119	OUT117	135	290	45x60
120	OUT118	90	375	45x60
121	OUT119	45	290	45x60
122	OUT120	0	375	45x60
123	OUT121	-45	290	45x60
124	OUT122	-90	375	45x60
125	OUT123	-135	290	45x60
126	OUT124	-180	375	45x60
127	OUT125	-225	290	45x60
128	OUT126	-270	375	45x60
129	OUT127	-315	290	45x60
130	OUT128	-360	375	45x60
131	OUT129	-405	290	45x60
132	OUT130	-450	375	45x60
133	OUT131	-495	290	45x60
134	OUT132	-540	375	45x60
135	OUT133	-585	290	45x60
136	OUT134	-630	375	45x60
137	OUT135	-675	290	45x60
138	OUT136	-720	375	45x60
139	OUT137	-765	290	45x60
140	OUT138	-810	375	45x60
141	OUT139	-855	290	45x60
142	OUT140	-900	375	45x60
143	OUT141	-945	290	45x60
144	OUT142	-990	375	45x60
145	OUT143	-1035	290	45x60
146	OUT144	-1080	375	45x60
147	OUT145	-1125	290	45x60
148	OUT146	-1170	375	45x60
149	OUT147	-1215	290	45x60
150	OUT148	-1260	375	45x60

No.	Name	X	Y	Bump size
151	OUT149	-1305	290	45x60
152	OUT150	-1350	375	45x60
153	OUT151	-1395	290	45x60
154	OUT152	-1440	375	45x60
155	OUT153	-1485	290	45x60
156	OUT154	-1530	375	45x60
157	OUT155	-1575	290	45x60
158	OUT156	-1620	375	45x60
159	OUT157	-1665	290	45x60
160	OUT158	-1710	375	45x60
161	OUT159	-1755	290	45x60
162	OUT160	-1800	375	45x60
163	OUT161	-1845	290	45x60
164	OUT162	-1890	375	45x60
165	OUT163	-1935	290	45x60
166	OUT164	-1980	375	45x60
167	OUT165	-2025	290	45x60
168	OUT166	-2070	375	45x60
169	OUT167	-2115	290	45x60
170	OUT168	-2160	375	45x60
171	OUT169	-2205	290	45x60
172	OUT170	-2250	375	45x60
173	OUT171	-2295	290	45x60
174	OUT172	-2340	375	45x60
175	OUT173	-2385	290	45x60
176	OUT174	-2430	375	45x60
177	OUT175	-2475	290	45x60
178	OUT176	-2520	375	45x60
179	OUT177	-2565	290	45x60
180	OUT178	-2610	375	45x60
181	OUT179	-2655	290	45x60
182	OUT180	-2700	375	45x60
183	OUT181	-2745	290	45x60
184	OUT182	-2790	375	45x60
185	OUT183	-2835	290	45x60
186	OUT184	-2880	375	45x60
187	OUT185	-2925	290	45x60
188	OUT186	-2970	375	45x60
189	OUT187	-3015	290	45x60
190	OUT188	-3060	375	45x60
191	OUT189	-3105	290	45x60
192	OUT190	-3150	375	45x60
193	OUT191	-3195	290	45x60
194	OUT192	-3240	375	45x60
195	OUT193	-3285	290	45x60
196	OUT194	-3330	375	45x60
197	OUT195	-3375	290	45x60
198	OUT196	-3420	375	45x60
199	OUT197	-3465	290	45x60
200	OUT198	-3510	375	45x60

No.	Name	X	Y	Bump size
201	OUT199	-3555	290	45x60
202	OUT200	-3600	375	45x60
203	OUT201	-3645	290	45x60
204	OUT202	-3690	375	45x60
205	OUT203	-3735	290	45x60
206	OUT204	-3780	375	45x60
207	OUT205	-3825	290	45x60
208	OUT206	-3870	375	45x60
209	OUT207	-3915	290	45x60
210	OUT208	-3960	375	45x60
211	OUT209	-4005	290	45x60
212	OUT210	-4050	375	45x60
213	OUT211	-4095	290	45x60
214	OUT212	-4140	375	45x60
215	OUT213	-4185	290	45x60
216	OUT214	-4230	375	45x60
217	OUT215	-4275	290	45x60
218	OUT216	-4320	375	45x60
219	OUT217	-4365	290	45x60
220	OUT218	-4410	375	45x60
221	OUT219	-4455	290	45x60
222	OUT220	-4500	375	45x60
223	OUT221	-4545	290	45x60
224	OUT222	-4590	375	45x60
225	OUT223	-4635	290	45x60
226	OUT224	-4680	375	45x60
227	OUT225	-4725	290	45x60
228	OUT226	-4770	375	45x60
229	OUT227	-4815	290	45x60
230	OUT228	-4860	375	45x60
231	OUT229	-4905	290	45x60
232	OUT230	-4950	375	45x60
233	OUT231	-4995	290	45x60
234	OUT232	-5040	375	45x60
235	OUT233	-5085	290	45x60
236	OUT234	-5130	375	45x60
237	OUT235	-5175	290	45x60
238	OUT236	-5220	375	45x60
239	OUT237	-5265	290	45x60
240	OUT238	-5310	375	45x60
241	OUT239	-5355	290	45x60
242	OUT240	-5400	375	45x60
243	OUT241	-5445	290	45x60
244	DUMMY	-5490	375	45x60
245	DUMMY	-5945	375	50x50
246	DUMMY	-5880	375	50x50
247	/XAO	-5945	300	50x50
248	/XAO	-5880	300	50x50
249	OE	-5945	225	50x50
250	OE	-5880	225	50x50

No.	Name	X	Y	Bump size
251	L/R	-5945	150	50x50
252	L/R	-5880	150	50x50
253	CPV	-5945	75	50x50
254	CPV	-5880	75	50x50
255	PATH	-5945	0	50x50
256	PATH	-5880	0	50x50
257	STV2	-5945	-75	50x50
258	STV2	-5880	-75	50x50
259	VGH	-5945	-150	50x50
260	VGH	-5880	-150	50x50
261	VEE	-5945	-225	50x50
262	VEE	-5880	-225	50x50
263	VDD	-5945	-300	50x50
264	VDD	-5880	-300	50x50
265	VSS	-5945	-375	50x50
266	VSS	-5880	-375	50x50
267	DUMMY	-5580	-400	45x85
268	DUMMY	-5490	-400	45x85
269	DUMMY	-5400	-400	45x85
270	DUMMY	-5310	-400	45x85
271	DUMMY	-5220	-400	45x85
272	DUMMY	-5130	-400	45x85
273	DUMMY	-5040	-400	45x85
274	DUMMY	-4950	-400	45x85
275	DUMMY	-4860	-400	45x85
276	DUMMY	-4770	-400	45x85
277	DUMMY	-4680	-400	45x85
278	DUMMY	-4590	-400	45x85
279	DUMMY	-4500	-400	45x85
280	DUMMY	-4410	-400	45x85
281	DUMMY	-4320	-400	45x85
282	DUMMY	-4230	-400	45x85
283	DUMMY	-4140	-400	45x85
284	DUMMY	-4050	-400	45x85
285	DUMMY	-3960	-400	45x85
286	DUMMY	-3870	-400	45x85
287	DUMMY	-3780	-400	45x85
288	DUMMY	-3690	-400	45x85
289	DUMMY	-3600	-400	45x85
290	DUMMY	-3510	-400	45x85
291	DUMMY	-3420	-400	45x85
292	DUMMY	-3330	-400	45x85
293	DUMMY	-3240	-400	45x85
294	DUMMY	-3150	-400	45x85
295	DUMMY	-3060	-400	45x85
296	DUMMY	-2970	-400	45x85
297	DUMMY	-2880	-400	45x85
298	DUMMY	-2790	-400	45x85
299	DUMMY	-2700	-400	45x85
300	DUMMY	-2610	-400	45x85

No.	Name	X	Y	Bump size
301	DUMMY	-2520	-400	45x85
302	DUMMY	-2430	-400	45x85
303	DUMMY	-2340	-400	45x85
304	DUMMY	-2250	-400	45x85
305	DUMMY	-2160	-400	45x85
306	DUMMY	-2070	-400	45x85
307	DUMMY	-1980	-400	45x85
308	DUMMY	-1890	-400	45x85
309	DUMMY	-1800	-400	45x85
310	DUMMY	-1710	-400	45x85
311	DUMMY	-1620	-400	45x85
312	DUMMY	-1530	-400	45x85
313	DUMMY	-1440	-400	45x85
314	DUMMY	-1350	-400	45x85
315	DUMMY	-1260	-400	45x85
316	DUMMY	-1170	-400	45x85
317	DUMMY	-1080	-400	45x85
318	DUMMY	-990	-400	45x85
319	DUMMY	-900	-400	45x85
320	DUMMY	-810	-400	45x85
321	DUMMY	-720	-400	45x85
322	DUMMY	-630	-400	45x85
323	DUMMY	-540	-400	45x85
324	DUMMY	-450	-400	45x85
325	DUMMY	-360	-400	45x85
326	DUMMY	-270	-400	45x85
327	DUMMY	-180	-400	45x85
328	DUMMY	-90	-400	45x85
329	DUMMY	0	-400	45x85
330	DUMMY	90	-400	45x85
331	DUMMY	180	-400	45x85
332	DUMMY	270	-400	45x85
333	DUMMY	360	-400	45x85
334	DUMMY	450	-400	45x85
335	DUMMY	540	-400	45x85
336	DUMMY	630	-400	45x85
337	DUMMY	720	-400	45x85
338	DUMMY	810	-400	45x85
339	DUMMY	900	-400	45x85
340	DUMMY	990	-400	45x85
341	DUMMY	1080	-400	45x85
342	DUMMY	1170	-400	45x85
343	DUMMY	1260	-400	45x85
344	DUMMY	1350	-400	45x85
345	DUMMY	1440	-400	45x85
346	DUMMY	1530	-400	45x85
347	DUMMY	1620	-400	45x85
348	DUMMY	1710	-400	45x85
349	DUMMY	1800	-400	45x85
350	DUMMY	1890	-400	45x85

No.	Name	X	Y	Bump size
351	DUMMY	1980	-400	45x85
352	DUMMY	2070	-400	45x85
353	DUMMY	2160	-400	45x85
354	DUMMY	2250	-400	45x85
355	DUMMY	2340	-400	45x85
356	DUMMY	2430	-400	45x85
357	DUMMY	2520	-400	45x85
358	DUMMY	2610	-400	45x85
359	DUMMY	2700	-400	45x85
360	DUMMY	2790	-400	45x85
361	DUMMY	2880	-400	45x85
362	DUMMY	2970	-400	45x85
363	DUMMY	3060	-400	45x85
364	DUMMY	3150	-400	45x85
365	DUMMY	3240	-400	45x85
366	DUMMY	3330	-400	45x85
367	DUMMY	3420	-400	45x85
368	DUMMY	3510	-400	45x85
369	DUMMY	3600	-400	45x85
370	DUMMY	3690	-400	45x85
371	DUMMY	3780	-400	45x85
372	DUMMY	3870	-400	45x85
373	DUMMY	3960	-400	45x85
374	DUMMY	4050	-400	45x85
375	DUMMY	4140	-400	45x85
376	DUMMY	4230	-400	45x85
377	DUMMY	4320	-400	45x85
378	DUMMY	4410	-400	45x85
379	DUMMY	4500	-400	45x85
380	DUMMY	4590	-400	45x85
381	DUMMY	4680	-400	45x85
382	DUMMY	4770	-400	45x85
383	DUMMY	4860	-400	45x85
384	DUMMY	4950	-400	45x85
385	DUMMY	5040	-400	45x85
386	DUMMY	5130	-400	45x85
387	DUMMY	5220	-400	45x85
388	DUMMY	5310	-400	45x85
389	DUMMY	5400	-400	45x85
390	DUMMY	5490	-400	45x85
391	DUMMY	5580	-400	45x85
392	VSS	5945	-375	50x50
393	VSS	5880	-375	50x50
394	VDD	5945	-300	50x50
395	VDD	5880	-300	50x50
396	VEE	5945	-225	50x50
397	VEE	5880	-225	50x50
398	VGH	5945	-150	50x50
399	VGH	5880	-150	50x50
400	STV1	5945	-75	50x50

No.	Name	X	Y	Bump size
401	STV1	5880	-75	50x50
402	PATH	5945	0	50x50
403	PATH	5880	0	50x50
404	CPV	5945	75	50x50
405	CPV	5880	75	50x50
406	L/R	5945	150	50x50
407	L/R	5880	150	50x50
408	OE	5945	225	50x50
409	OE	5880	225	50x50
410	/XAO	5945	300	50x50
411	/XAO	5880	300	50x50
412	DUMMY	5945	375	50x50
413	DUMMY	5880	375	50x50

9.5 Alignment Mark center coordinate

Name	X	Y
L_AMK	-5722	-390
R_AMK	5722	-390

Himax Confidential
Do Not Copy

10. Ordering Information

Part No.	Package
HX8615BPDxxx	PD : mean COG xxx : mean chip thickness (μm) , (default 400 μm)

11. Revision History

VERSION	EFF.DATE	DESCRIPTION OF CHANGES
01	2004/05/11	New setup
02	2004/07/28	Make up no. 401~413 pad coordinate.
03	2004/11/15	1. Modify STV1/2,OE,/XAO description,page3. 2. Add "Bump Outline Dimensions" item to substituted 9.2~9.4 section, page 9.
04	2005/04/19	Update pad information, page9~16.
	2005/05/09	Revise the pull high resistance spec, page7.

Himax Confidential
Do Not Copy