



DATA SHEET

(DOC No. HX8695-B02-DS)

HX8695-B02

800CH TFT LCD Gate Driver

Preliminary version 01 September, 2009

Himax Technologies, Inc.

<http://www.himax.com.tw>

1. General Description

The HX8695-B02 is an 800-channel outputs gate driver, which is used for driving the gate line of TFT LCD panel. It is designed for 2-level output with 40V LCD driving voltage range.

2. Features

- | 2-level output
- | 800/768/720 channel outputs selectable with 2 dummy outputs
- | Various scan function can support various dual gate driving sequence
- | Maximum 200KHz operation frequency
- | Digital supply voltage: 2.3V to 3.6V
- | LCD driving voltage range: 40V
- | Bi-directional data shift capability
- | High voltage CMOS process technology
- | COG/COF package

Himax Confidential
Do Not Copy

3. Block Diagram

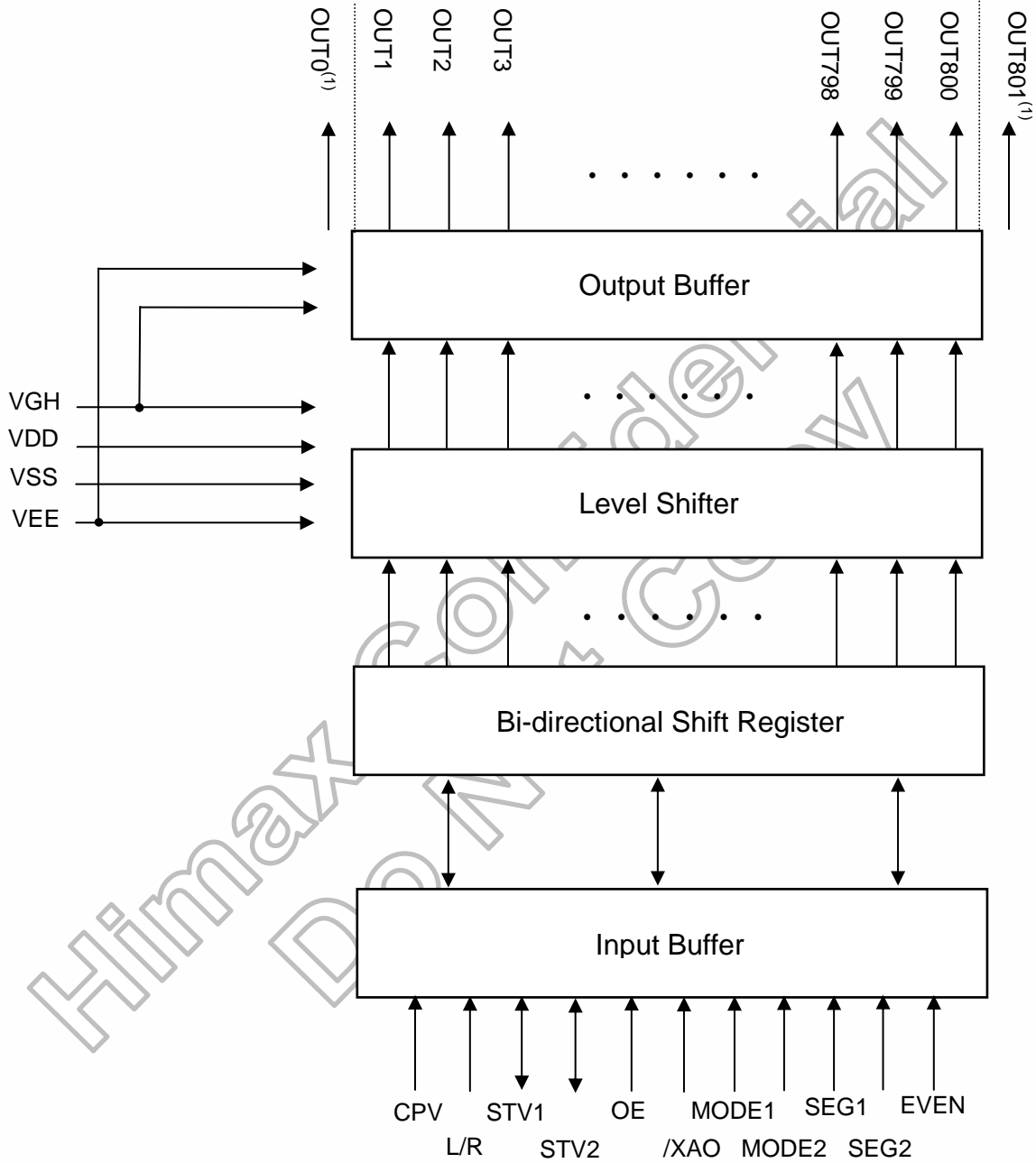

Note: (1) OUT0 and OUT801 are LCD panel auxiliary pins; these pins always output VEE level.

4. Pin Description

Pin Name	I/O	Function	Description																
CPV	In	Shift clock input	The clock for the internal shift registers.																
L/R	In	Shift direction control pin	The shift direction of device internal shift register is controlled by this pin as shown below: L/R =H:STV1→OUT1→OUT2→...→OUT800→STV2. L/R =L:STV2→OUT800→...→OUT2→OUT1→STV1. This pin pulling down internally.																
STV1 STV2	I/O	Start pulse input/output pin	L/R=H, STV1 is used for start pulse input; STV2 is used for start pulse output. L/R =L, STV2 is used for start pulse input; STV1 is used for start pulse output.																
OE	In	Output enable control	The OE signal control the output enable. OE=H: All driver outputs are fixed to VEE regardless of CPV. However, the content of shift register is notcleared. OE=L: Normal operation.																
/XAO	In	Output all-on control	When /XAO is set to L, all outputs are fixed to VGH. Note that this pin has higher priority than OE. However, the content of shift register is not cleared. /XAO is pulled high to VDD internally. When it is not used, connecting to VDD is recommended.																
MODE1 MODE2	In	Channel mode selection	Channel mode selection. MODE1 and MODE2 are pulling high internally. <table border="1"> <thead> <tr> <th>Output channel</th> <th>Disable channel</th> <th>MODE2</th> <th>MODE1</th> </tr> </thead> <tbody> <tr> <td>800</td> <td>-</td> <td>H</td> <td>H</td> </tr> <tr> <td>720</td> <td>361~440</td> <td>H</td> <td>L</td> </tr> <tr> <td>768</td> <td>385~416</td> <td>L</td> <td>X</td> </tr> </tbody> </table>	Output channel	Disable channel	MODE2	MODE1	800	-	H	H	720	361~440	H	L	768	385~416	L	X
Output channel	Disable channel	MODE2	MODE1																
800	-	H	H																
720	361~440	H	L																
768	385~416	L	X																
SEG1 SEG2	In	Scan function selection	SEG1 and SEG2 are pulling low internally. <table border="1"> <thead> <tr> <th>Scan function</th> <th>SEG1</th> <th>SEG2</th> </tr> </thead> <tbody> <tr> <td>Z1</td> <td>L</td> <td>L</td> </tr> <tr> <td>Z1</td> <td>L</td> <td>H</td> </tr> <tr> <td>弓</td> <td>H</td> <td>L</td> </tr> <tr> <td>Z2</td> <td>H</td> <td>H</td> </tr> </tbody> </table>	Scan function	SEG1	SEG2	Z1	L	L	Z1	L	H	弓	H	L	Z2	H	H	
Scan function	SEG1	SEG2																	
Z1	L	L																	
Z1	L	H																	
弓	H	L																	
Z2	H	H																	
EVEN	In	Frame selection	EVEN is pulling low internally. <table border="1"> <thead> <tr> <th>Frame</th> <th>EVEN</th> </tr> </thead> <tbody> <tr> <td>Odd</td> <td>L</td> </tr> <tr> <td>Even</td> <td>H</td> </tr> </tbody> </table>	Frame	EVEN	Odd	L	Even	H										
Frame	EVEN																		
Odd	L																		
Even	H																		
OUT1~ OUT800	Out	Driver output	The output is either VGH or VEE for driving the gate line of TFT LCD panel.																
OUT0 OUT801	Out	Auxiliary pins	These two pins always output VEE level.																
VDD	In	Power supply	Digital power supply.																
VSS	In	Power supply	Grounding for VDD.																
VGH	In	Power supply	Power supply for Gate on output.																
VEE	In	Power supply	Power supply for Gate off output.																
PATH1 PATH2	In	Internal link	Linked together internal.																

5. Function Description

5.1 Device operation

When L/R=H and MODE=H, the STV1 start pulse input is sensed on the rising edge of CPV and stored in the first stage of shift register, which makes the first scan signal output from the OUT1 pin. While stored data is transferred to the next stage shift register on the rising edge of next CPV, new data of STV1 is sensed and stored simultaneously.

The output pin (OUT1 to OUT800) supplies VGH voltage or VEE voltage to the LCD panel depending on the data stored in the shift register. For normal operation, a VGH voltage is outputted one by one from OUT1 to OUT800 in synchronization with CPV pulse. According to SEG1, SEG2, and EVEN pins setting, it is possible to get other different output sequence (Described in section 5.2).

After 800 CPV rising edge are past, the STV2 goes up to high level at the 800th falling edge of CPV and goes down to low level at the 801st falling edge of CPV. This STV2 output signal becomes the STV1 start pulse input of next cascaded gate driver.

When OE=H, the corresponding output channels are fixed to VEE level regardless of CPV. The channel output returns to normal status as soon as OE goes back to L.

Himax Confidential
Do Not Copy

Example of input/output timing

(MODE2=H, MODE1=H, SEG1=L, SEG2=X, EVEN=L, L/R=H)

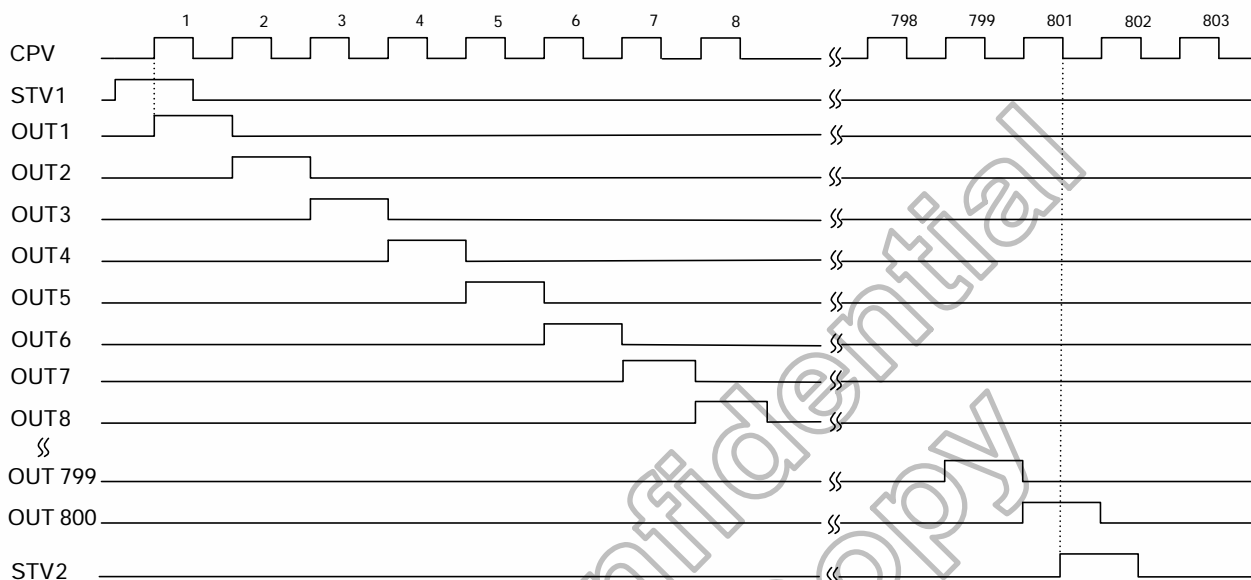

Example of input/output timing

(MODE2=H, MODE1=H, SEG1=L, SEG2=X, EVEN=H, L/R=H)

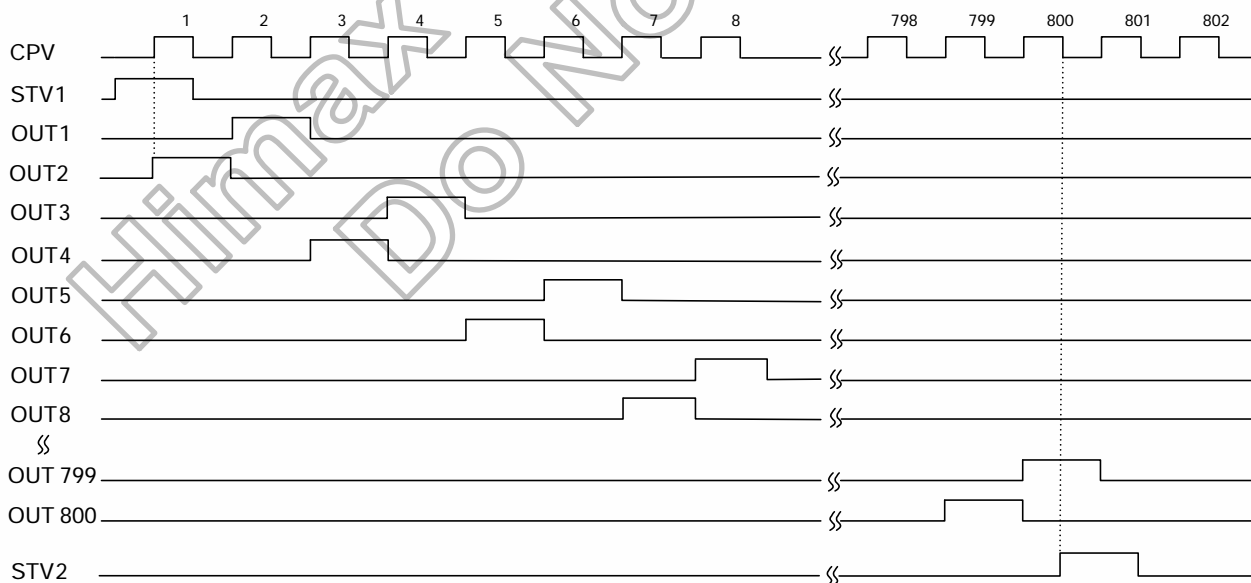

Example of input/output timing

(MODE2=H, MODE1=H, SEG1=L, SEG2=X, EVEN=L, L/R=L)

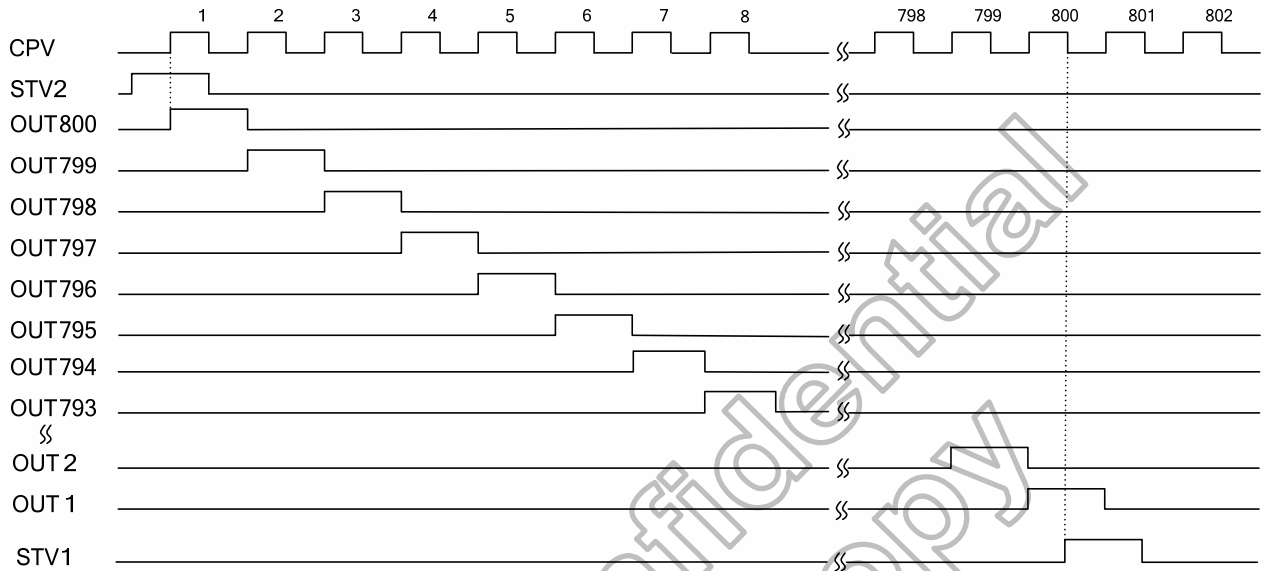

Example of input/output timing

(MODE2=H, MODE1=H, SEG1=L, SEG2=X, EVEN=H, L/R=L)

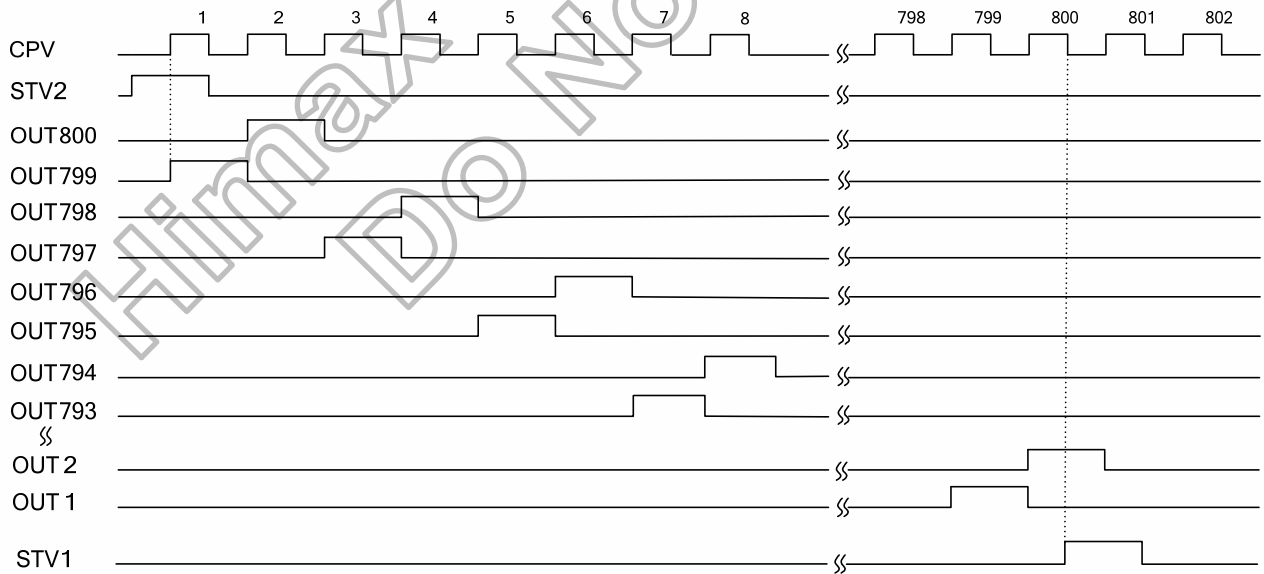

Example of input/output timing

(MODE2=H, MODE1=H, SEG1=H, SEG2=L, EVEN=L, L/R=H)

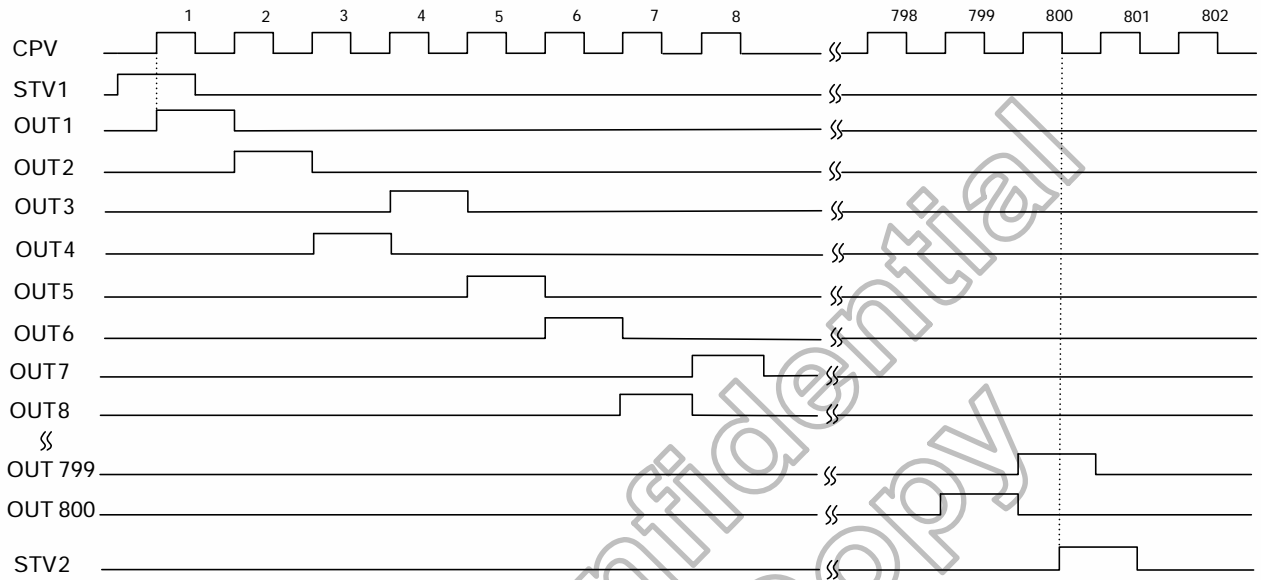

Example of input/output timing

(MODE2=H, MODE1=H, SEG1=H, SEG2=L, EVEN=H, L/R=H)

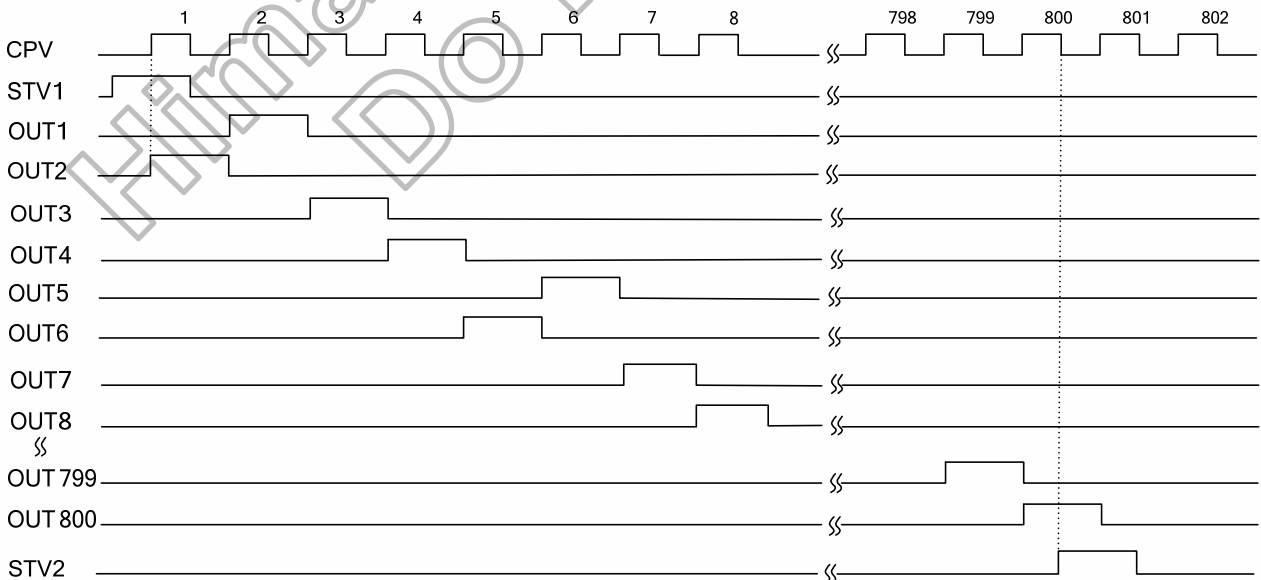

Example of input/output timing

(MODE2=H, MODE1=H, SEG1=H SEG2=L, EVEN=L, L/R=L)

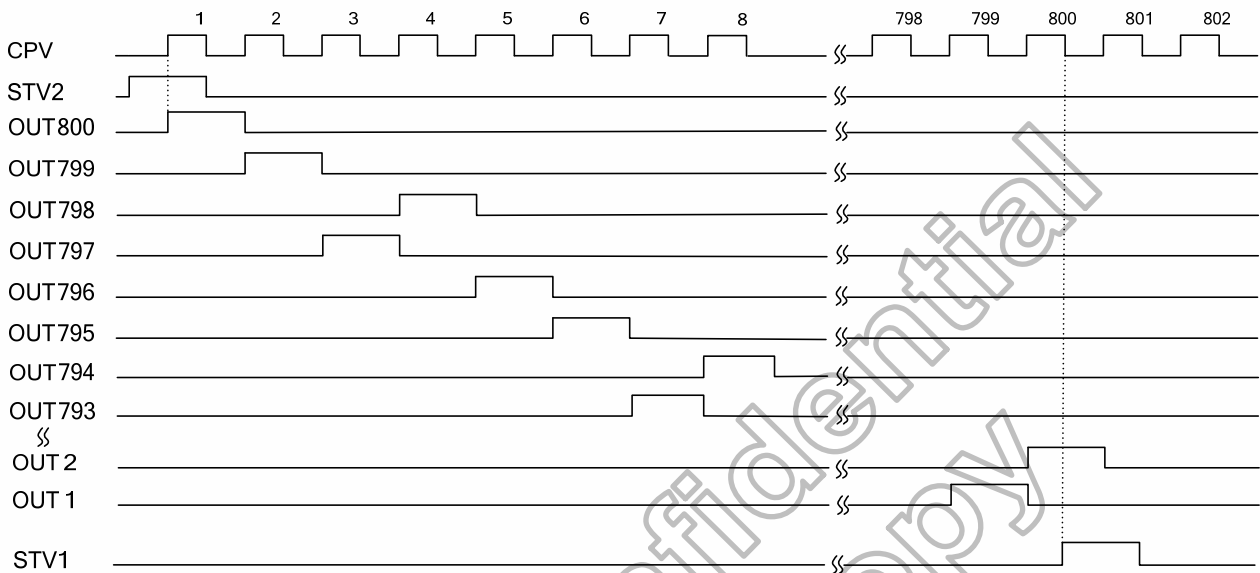

Example of input/output timing

(MODE2=H, MODE1=H, SEG1=H, SEG2=L, EVEN=H, L/R=L)

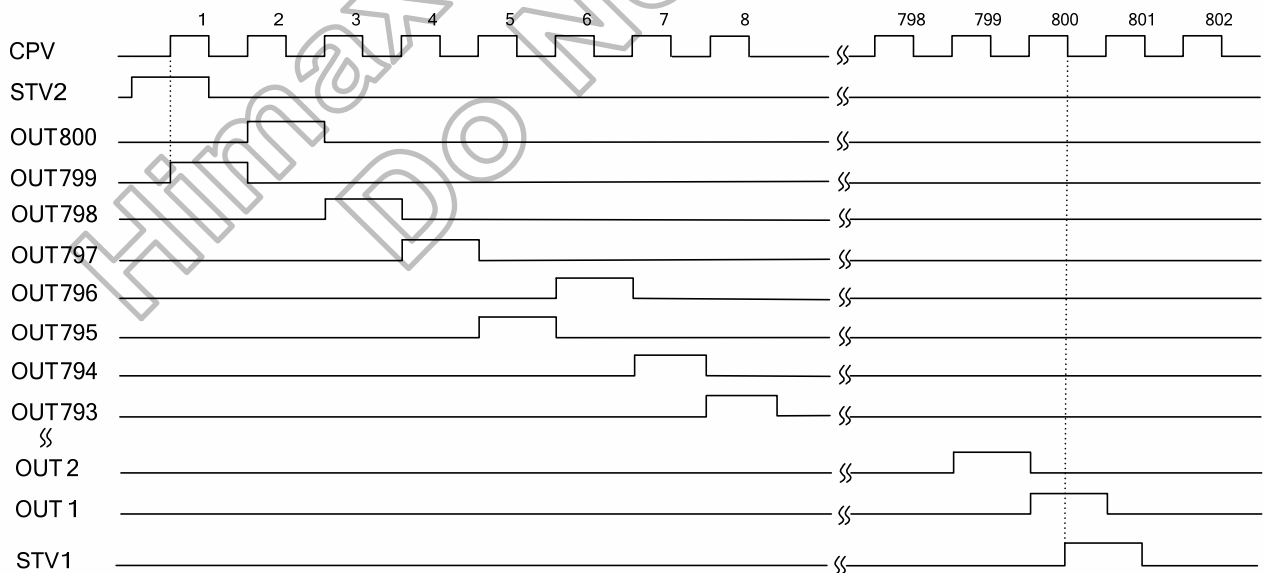

Example of input/output timing

(MODE2=H, MODE1=H, SEG1=H, SEG2=H, EVEN=L, L/R=H)

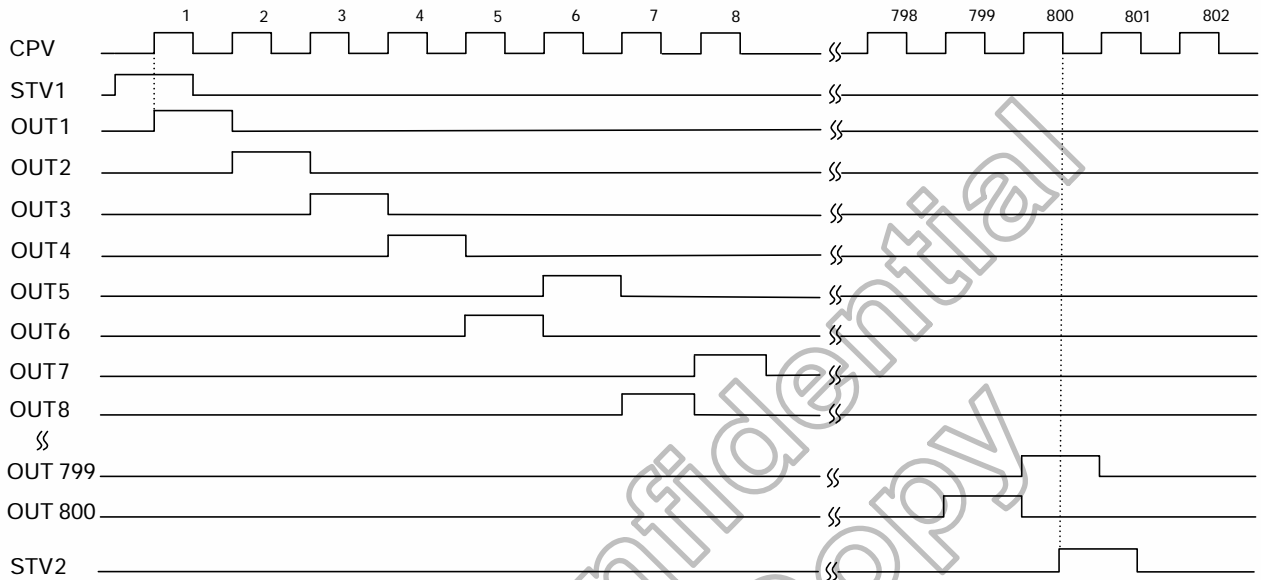

Example of input/output timing

(MODE2=H, MODE1=H, SEG1=H, SEG2=H, EVEN=H, L/R=H)

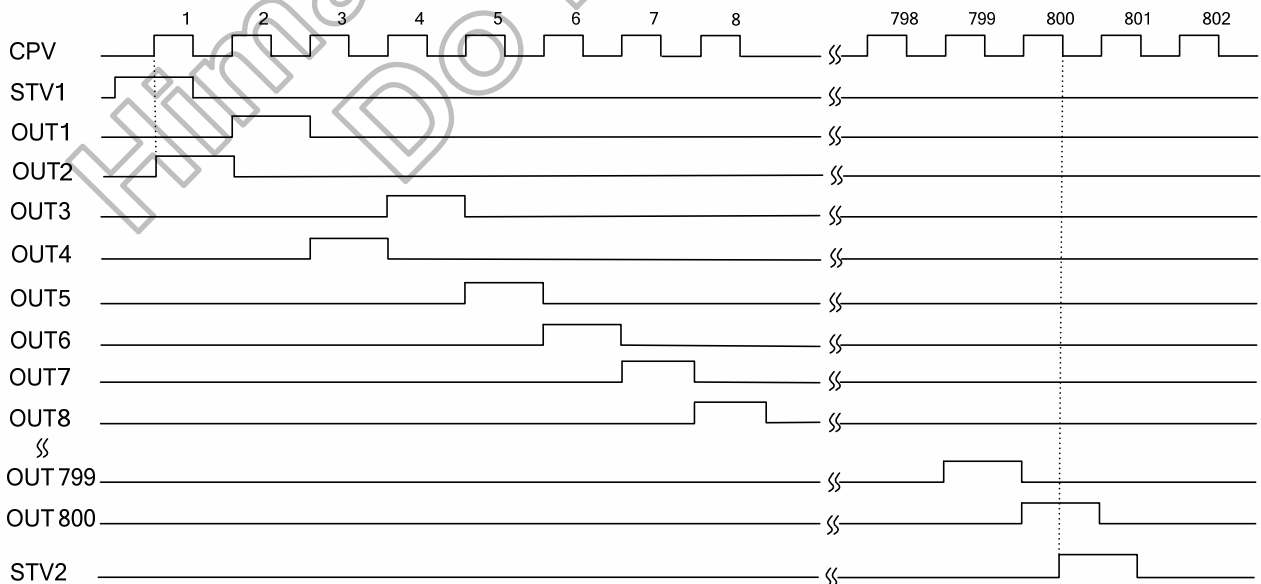

Example of input/output timing

(MODE2=H, MODE1=H, SEG1=H SEG2=H, EVEN=L, L/R=L)

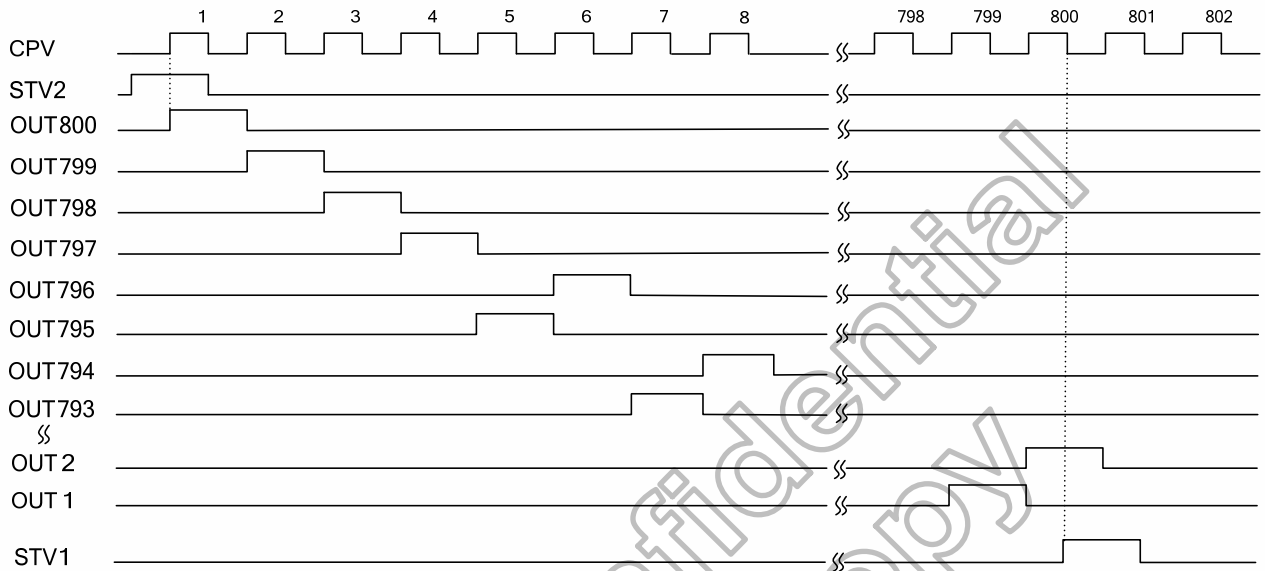

Example of input/output timing

(MODE2=H, MODE1=H, SEG1=H, SEG2=H, EVEN=H, L/R=L)

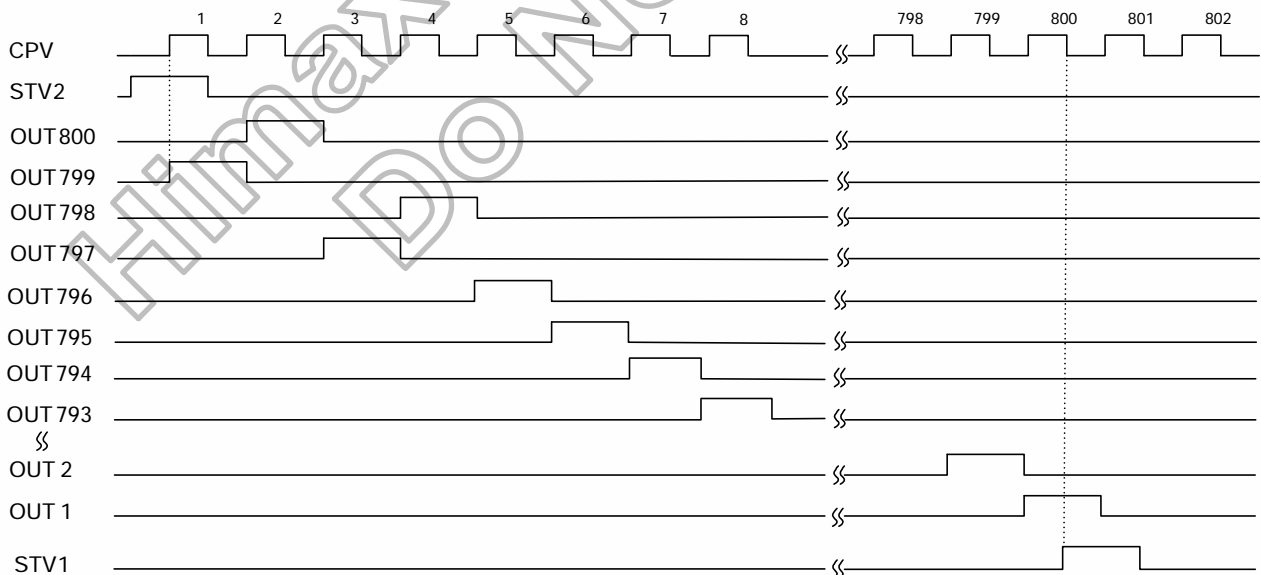

5.2 Device power supply

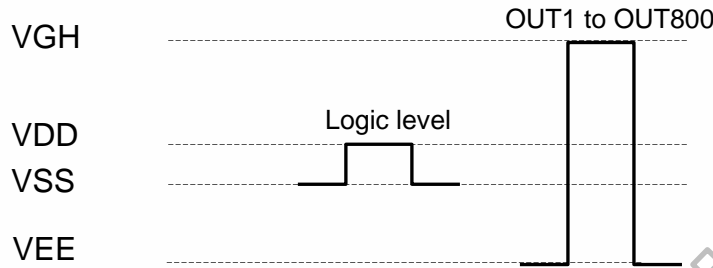

The logic levels of CPV, L/R, OE, /XAO, MODE1, MODE2, SEG1, SEG2, EVEN, STV1 and STV2 have to swing between VDD for “H” and VSS for “L”.

5.3 Power on/off sequence

To prevent the device from damage due to latch up, the power on/off sequence shown below must be followed.

When power on: VDD → VEE → VGH

When power off: VGH → VEE → VDD

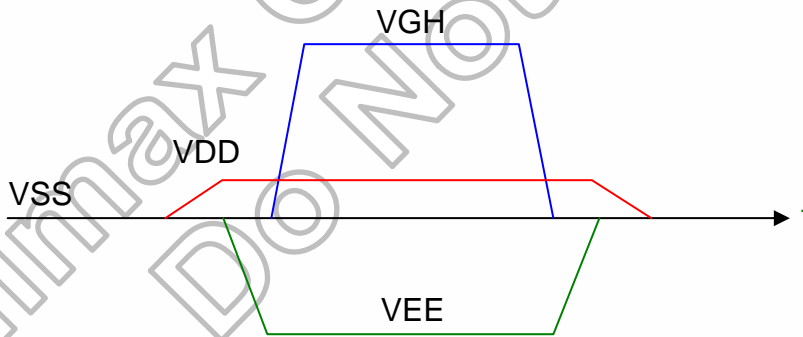

6. DC Characteristics

6.1 Absolute maximum rating (VSS=0V)

Parameter	Symbol	Spec.			Unit
		Min.	Typ.	Max.	
Power supply voltage 1	VGH	-0.3	-	+42.0	V
Power supply voltage 2	VDD	-0.3	-	+7.0	V
Power supply voltage 3	VEE	VGH-42	-	+0.3	V
Input voltage	V _{IN}	-0.3	-	VDD+0.3	V
Storage temperature	T _{STG}	-55	-	+125	°C

Note: Device will probably be damaged permanently in case that the stresses are over the absolute maximum ratings listed above.

6.2 Recommended operating conditions (VSS=0V)

Parameter	Symbol	Spec.			Unit
		Min.	Typ.	Max.	
Power supply voltage 1	VGH	7	-	VEE+40	V
Power supply voltage 2	VDD	2.3	3.3	3.6	V
Power supply voltage 3	VEE	-20	-	-5	V
Power supply voltage 4	VGH - VEE	12	-	40	V
Operation frequency	F _{CPV}	-	-	200	KHz
Operation temperature	T _A	-40	-	+95	°C

6.3 Electrical characteristics (VSS=0V)

Parameter	Symbol	Applicable pin	Condition	Spec.			Unit
				Min.	Typ.	Max.	
Input H voltage	V _{IH}	All input pins	-	0.7VDD	-	VDD	V
Input L voltage	V _{IL}	All input pins	-	VSS	-	0.3VDD	
Output H voltage	V _{OH}	STV1,2	I _{OH} =40μA	VDD-0.4	-	VDD	
Output L voltage	V _{OL}	STV1,2	I _{OL} =40μA	VSS	-	VSS+0.4	
Output H resistance	R _{OH}	OUT1 ~ OUT800	V _{OUT} = VGH -0.5V	-	-	1000	Ω
Output L resistance	R _{OL}	OUT1 ~ OUT800	V _{OUT} = VEE+0.5V	-	-	1000	Ω
Input leakage current	I _{IN}	Note ⁽²⁾	-	-1.0	-	+1.0	μA
Pull high resistance	R _{PU}	/XAO	-	40	-	200	kΩ
Pull low resistance	R _{PD}	SEG1,SEG2 L/R	-	40	-	200	kΩ
VGH Power consumption	I _{VGH}	VGH	Note ⁽¹⁾	-	-	200	μA
VDD Power consumption	I _{VDD}	VDD		-	-	100	

Note: (1) Power consumption in the following condition:

Output no load, VGH=20V, VEE=-8V, VDD=3.0V, V_{IH}=VDD, V_{IL}=VSS, F_{CPV}=50KHz, OE=V_{IL}, /XAO=V_{IH}.

(2) All input except /XAO.

7. AC Characteristics

Parameter	Symbol	Condition	Spec.			Unit
			Min.	Typ.	Max.	
CPV period	t_{CPV}	-	5	-	-	μs
CPV pulse width	t_{CPVH}, t_{CPVL}	50% duty cycle	2.5	-	-	
OE pulse width	t_{WOE}	-	1	-	-	
/XAO pulse width	t_{WXAO}	-	10	-	-	
Data setup time	t_{SU}	-	1.0	-	-	
Data hold time	t_{HD}	-	1.0	-	-	
EVEN setup time	t_{MSU}	-	1.0	-	-	
EVEN hold time	t_{MHD}	-	1.0	-	-	
CPV to output delay time	t_{PD1}	CL=300pF	-	-	1.2	
Start pulse output delay time	t_{PD2}	Loading=30pF	-	-	1.2	
OE to output delay time	t_{PD3}	CL=300pF	-	-	0.8	
/XAO to output delay time	t_{PD4}	CL=300pF	-	-	50	

Note: The measurement point for all of above signals is at 50% of input/output amplitude.

Himax Confidential
Do Not Copy

8. Waveform

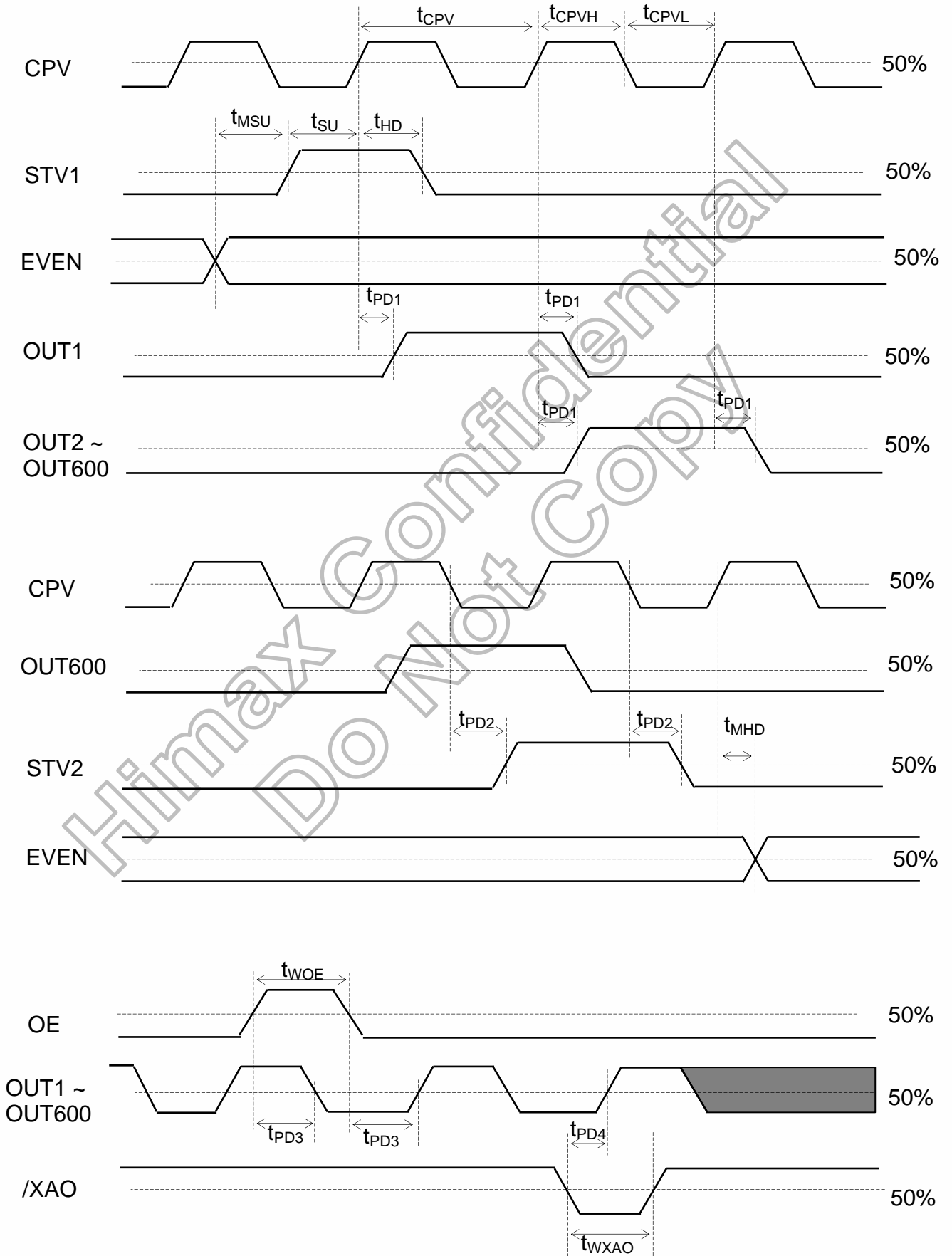

9. Pad Coordinates

9.1 HX8695-B02 gate driver bump location

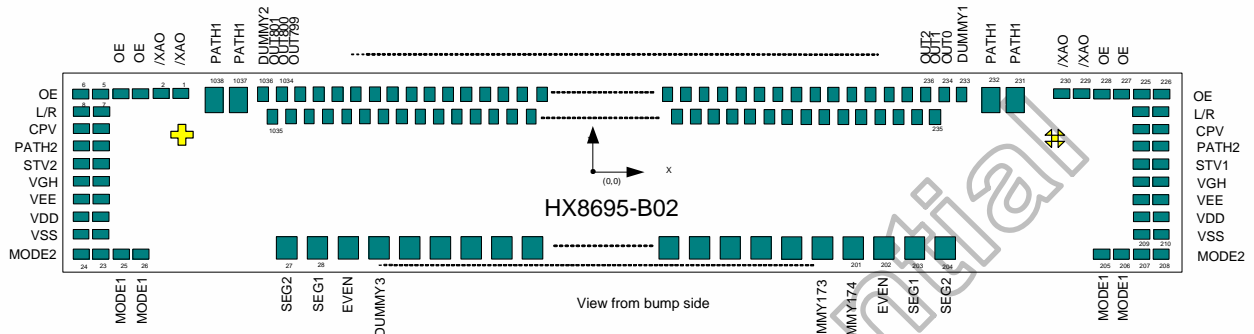

Chip size: 19140µm x 710µm (scribe line included)
 Scribe line: 80µm
 Bump height: 15±3µm

9.2 Bump outline dimensions

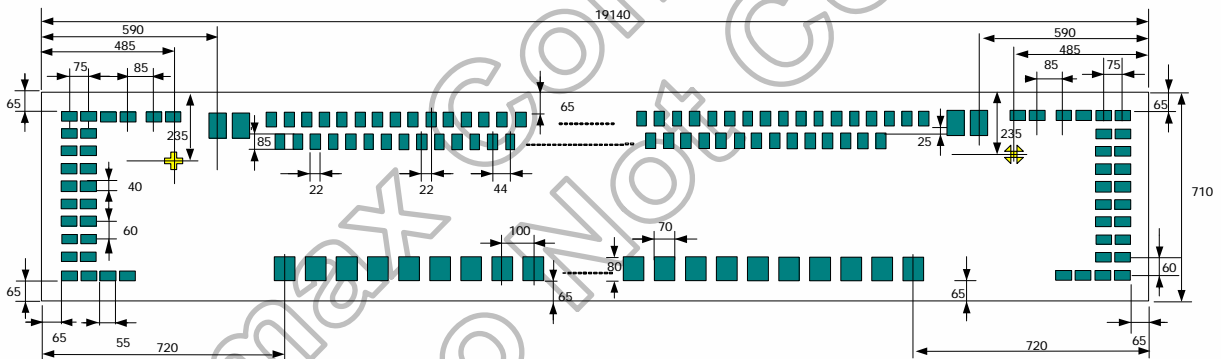

9.3 Alignment mark

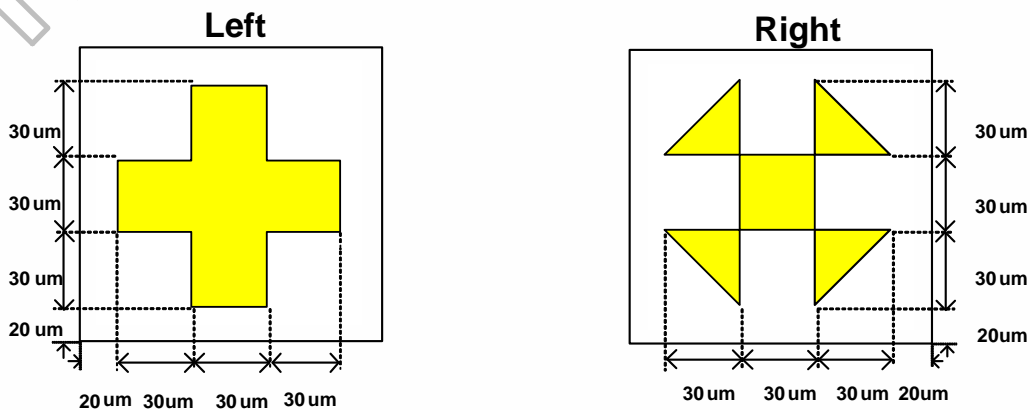

9.4 Bump center coordinates

No.	Name	X	Y	Bump size(μm)
1	/XAO	-9092.5	270	55 x 40
2	/XAO	-9167.5	270	55 x 40
3	OE	-9252.5	270	55 x 40
4	OE	-9327.5	270	55 x 40
5	OE	-9402.5	270	55 x 40
6	OE	-9477.5	270	55 x 40
7	L/R	-9402.5	210	55 x 40
8	L/R	-9477.5	210	55 x 40
9	CPV	-9402.5	150	55 x 40
10	CPV	-9477.5	150	55 x 40
11	PATH2	-9402.5	90	55 x 40
12	PATH2	-9477.5	90	55 x 40
13	SVT2	-9402.5	30	55 x 40
14	SVT2	-9477.5	30	55 x 40
15	VGH	-9402.5	-30	55 x 40
16	VGH	-9477.5	-30	55 x 40
17	VEE	-9402.5	-90	55 x 40
18	VEE	-9477.5	-90	55 x 40
19	VDD	-9402.5	-150	55 x 40
20	VDD	-9477.5	-150	55 x 40
21	VSS	-9402.5	-210	55 x 40
22	VSS	-9477.5	-210	55 x 40
23	MODE2	-9402.5	-270	55 x 40
24	MODE2	-9477.5	-270	55 x 40
25	MODE1	-9327.5	-270	55 x 40
26	MODE1	-9252.5	-270	55 x 40
27	SEG2	-8850	-250	70 x 80
28	SEG1	-8750	-250	70 x 80
29	EVEN	-8650	-250	70 x 80
30	DUMMY3	-8550	-250	70 x 80
31	DUMMY4	-8450	-250	70 x 80
32	DUMMY5	-8350	-250	70 x 80
33	DUMMY6	-8250	-250	70 x 80
34	DUMMY7	-8150	-250	70 x 80
35	DUMMY8	-8050	-250	70 x 80
36	DUMMY9	-7950	-250	70 x 80
37	DUMMY10	-7850	-250	70 x 80
38	DUMMY11	-7750	-250	70 x 80
39	DUMMY12	-7650	-250	70 x 80
40	DUMMY13	-7550	-250	70 x 80
41	DUMMY14	-7450	-250	70 x 80
42	DUMMY15	-7350	-250	70 x 80
43	DUMMY16	-7250	-250	70 x 80
44	DUMMY17	-7150	-250	70 x 80
45	DUMMY18	-7050	-250	70 x 80
46	DUMMY19	-6950	-250	70 x 80
47	DUMMY20	-6850	-250	70 x 80
48	DUMMY21	-6750	-250	70 x 80
49	DUMMY22	-6650	-250	70 x 80
50	DUMMY23	-6550	-250	70 x 80
51	DUMMY24	-6450	-250	70 x 80
52	DUMMY25	-6350	-250	70 x 80
53	DUMMY26	-6250	-250	70 x 80
54	DUMMY27	-6150	-250	70 x 80
55	DUMMY28	-6050	-250	70 x 80
56	DUMMY29	-5950	-250	70 x 80
57	DUMMY30	-5850	-250	70 x 80
58	DUMMY31	-5750	-250	70 x 80
59	DUMMY32	-5650	-250	70 x 80
60	DUMMY33	-5550	-250	70 x 80

No.	Name	X	Y	Bump size(μm)
61	DUMMY34	-5450	-250	70 x 80
62	DUMMY35	-5350	-250	70 x 80
63	DUMMY36	-5250	-250	70 x 80
64	DUMMY37	-5150	-250	70 x 80
65	DUMMY38	-5050	-250	70 x 80
66	DUMMY39	-4950	-250	70 x 80
67	DUMMY40	-4850	-250	70 x 80
68	DUMMY41	-4750	-250	70 x 80
69	DUMMY42	-4650	-250	70 x 80
70	DUMMY43	-4550	-250	70 x 80
71	DUMMY44	-4450	-250	70 x 80
72	DUMMY45	-4350	-250	70 x 80
73	DUMMY46	-4250	-250	70 x 80
74	DUMMY47	-4150	-250	70 x 80
75	DUMMY48	-4050	-250	70 x 80
76	DUMMY49	-3950	-250	70 x 80
77	DUMMY50	-3850	-250	70 x 80
78	DUMMY51	-3750	-250	70 x 80
79	DUMMY52	-3650	-250	70 x 80
80	DUMMY53	-3550	-250	70 x 80
81	DUMMY54	-3450	-250	70 x 80
82	DUMMY55	-3350	-250	70 x 80
83	DUMMY56	-3250	-250	70 x 80
84	DUMMY57	-3150	-250	70 x 80
85	DUMMY58	-3050	-250	70 x 80
86	DUMMY59	-2950	-250	70 x 80
87	DUMMY60	-2850	-250	70 x 80
88	DUMMY61	-2750	-250	70 x 80
89	DUMMY62	-2650	-250	70 x 80
90	DUMMY63	-2550	-250	70 x 80
91	DUMMY64	-2450	-250	70 x 80
92	DUMMY65	-2350	-250	70 x 80
93	DUMMY66	-2250	-250	70 x 80
94	DUMMY67	-2150	-250	70 x 80
95	DUMMY68	-2050	-250	70 x 80
96	DUMMY69	-1950	-250	70 x 80
97	DUMMY70	-1850	-250	70 x 80
98	DUMMY71	-1750	-250	70 x 80
99	DUMMY72	-1650	-250	70 x 80
100	DUMMY73	-1550	-250	70 x 80
101	DUMMY74	-1450	-250	70 x 80
102	DUMMY75	-1350	-250	70 x 80
103	DUMMY76	-1250	-250	70 x 80
104	DUMMY77	-1150	-250	70 x 80
105	DUMMY78	-1050	-250	70 x 80
106	DUMMY79	-950	-250	70 x 80
107	DUMMY80	-850	-250	70 x 80
108	DUMMY81	-750	-250	70 x 80
109	DUMMY82	-650	-250	70 x 80
110	DUMMY83	-550	-250	70 x 80
111	DUMMY84	-450	-250	70 x 80
112	DUMMY85	-350	-250	70 x 80
113	DUMMY86	-250	-250	70 x 80
114	DUMMY87	-150	-250	70 x 80
115	DUMMY88	-50	-250	70 x 80
116	DUMMY89	50	-250	70 x 80
117	DUMMY90	150	-250	70 x 80
118	DUMMY91	250	-250	70 x 80
119	DUMMY92	350	-250	70 x 80
120	DUMMY93	450	-250	70 x 80

No.	Name	X	Y	Bump size(μm)
121	DUMMY94	550	-250	70 x 80
122	DUMMY95	650	-250	70 x 80
123	DUMMY96	750	-250	70 x 80
124	DUMMY97	850	-250	70 x 80
125	DUMMY98	950	-250	70 x 80
126	DUMMY99	1050	-250	70 x 80
127	DUMMY100	1150	-250	70 x 80
128	DUMMY101	1250	-250	70 x 80
129	DUMMY102	1350	-250	70 x 80
130	DUMMY103	1450	-250	70 x 80
131	DUMMY104	1550	-250	70 x 80
132	DUMMY105	1650	-250	70 x 80
133	DUMMY106	1750	-250	70 x 80
134	DUMMY107	1850	-250	70 x 80
135	DUMMY108	1950	-250	70 x 80
136	DUMMY109	2050	-250	70 x 80
137	DUMMY110	2150	-250	70 x 80
138	DUMMY111	2250	-250	70 x 80
139	DUMMY112	2350	-250	70 x 80
140	DUMMY113	2450	-250	70 x 80
141	DUMMY114	2550	-250	70 x 80
142	DUMMY115	2650	-250	70 x 80
143	DUMMY116	2750	-250	70 x 80
144	DUMMY117	2850	-250	70 x 80
145	DUMMY118	2950	-250	70 x 80
146	DUMMY119	3050	-250	70 x 80
147	DUMMY120	3150	-250	70 x 80
148	DUMMY121	3250	-250	70 x 80
149	DUMMY122	3350	-250	70 x 80
150	DUMMY123	3450	-250	70 x 80
151	DUMMY124	3550	-250	70 x 80
152	DUMMY125	3650	-250	70 x 80
153	DUMMY126	3750	-250	70 x 80
154	DUMMY127	3850	-250	70 x 80
155	DUMMY128	3950	-250	70 x 80
156	DUMMY129	4050	-250	70 x 80
157	DUMMY130	4150	-250	70 x 80
158	DUMMY131	4250	-250	70 x 80
159	DUMMY132	4350	-250	70 x 80
160	DUMMY133	4450	-250	70 x 80
161	DUMMY134	4550	-250	70 x 80
162	DUMMY135	4650	-250	70 x 80
163	DUMMY136	4750	-250	70 x 80
164	DUMMY137	4850	-250	70 x 80
165	DUMMY138	4950	-250	70 x 80
166	DUMMY139	5050	-250	70 x 80
167	DUMMY140	5150	-250	70 x 80
168	DUMMY141	5250	-250	70 x 80
169	DUMMY142	5350	-250	70 x 80
170	DUMMY143	5450	-250	70 x 80
171	DUMMY144	5550	-250	70 x 80
172	DUMMY145	5650	-250	70 x 80
173	DUMMY146	5750	-250	70 x 80
174	DUMMY147	5850	-250	70 x 80
175	DUMMY148	5950	-250	70 x 80
176	DUMMY149	6050	-250	70 x 80
177	DUMMY150	6150	-250	70 x 80
178	DUMMY151	6250	-250	70 x 80
179	DUMMY152	6350	-250	70 x 80
180	DUMMY153	6450	-250	70 x 80

No.	Name	X	Y	Bump size(μm)
181	DUMMY154	6550	-250	70 x 80
182	DUMMY155	6650	-250	70 x 80
183	DUMMY156	6750	-250	70 x 80
184	DUMMY157	6850	-250	70 x 80
185	DUMMY158	6950	-250	70 x 80
186	DUMMY159	7050	-250	70 x 80
187	DUMMY160	7150	-250	70 x 80
188	DUMMY161	7250	-250	70 x 80
189	DUMMY162	7350	-250	70 x 80
190	DUMMY163	7450	-250	70 x 80
191	DUMMY164	7550	-250	70 x 80
192	DUMMY165	7650	-250	70 x 80
193	DUMMY166	7750	-250	70 x 80
194	DUMMY167	7850	-250	70 x 80
195	DUMMY168	7950	-250	70 x 80
196	DUMMY169	8050	-250	70 x 80
197	DUMMY170	8150	-250	70 x 80
198	DUMMY171	8250	-250	70 x 80
199	DUMMY172	8350	-250	70 x 80
200	DUMMY173	8450	-250	70 x 80
201	DUMMY174	8550	-250	70 x 80
202	EVEN	8650	-250	70 x 80
203	SEG1	8750	-250	70 x 80
204	SEG2	8850	-250	70 x 80
205	MODE1	9252.5	-270	55 x 40
206	MODE1	9327.5	-270	55 x 40
207	MODE2	9402.5	-270	55 x 40
208	MODE2	9477.5	-270	55 x 40
209	VSS	9402.5	-210	55 x 40
210	VSS	9477.5	-210	55 x 40
211	VDD	9402.5	-150	55 x 40
212	VDD	9477.5	-150	55 x 40
213	VEE	9402.5	-90	55 x 40
214	VEE	9477.5	-90	55 x 40
215	VGH	9402.5	-30	55 x 40
216	VGH	9477.5	-30	55 x 40
217	SVT1	9402.5	30	55 x 40
218	SVT1	9477.5	30	55 x 40
219	PATH2	9402.5	90	55 x 40
220	PATH2	9477.5	90	55 x 40
221	CPV	9402.5	150	55 x 40
222	CPV	9477.5	150	55 x 40
223	L/R	9402.5	210	55 x 40
224	L/R	9477.5	210	55 x 40
225	OE	9402.5	270	55 x 40
226	OE	9477.5	270	55 x 40
227	OE	9327.5	270	55 x 40
228	OE	9252.5	270	55 x 40
229	/XAO	9167.5	270	55 x 40
230	/XAO	9092.5	270	55 x 40
231	PATH1	8980	235	50 x 110
232	PATH1	8910	235	50 x 110
233	DUMMY1	8844	247.5	22 x 85
234	OUT0	8800	247.5	22 x 85
235	OUT1	8778	137.5	22 x 85
236	OUT2	8756	247.5	22 x 85
237	OUT3	8734	137.5	22 x 85
238	OUT4	8712	247.5	22 x 85
239	OUT5	8690	137.5	22 x 85
240	OUT6	8668	247.5	22 x 85

No.	Name	X	Y	Bump size(μm)
241	OUT7	8646	137.5	22 x 85
242	OUT8	8624	247.5	22 x 85
243	OUT9	8602	137.5	22 x 85
244	OUT10	8580	247.5	22 x 85
245	OUT11	8558	137.5	22 x 85
246	OUT12	8536	247.5	22 x 85
247	OUT13	8514	137.5	22 x 85
248	OUT14	8492	247.5	22 x 85
249	OUT15	8470	137.5	22 x 85
250	OUT16	8448	247.5	22 x 85
251	OUT17	8426	137.5	22 x 85
252	OUT18	8404	247.5	22 x 85
253	OUT19	8382	137.5	22 x 85
254	OUT20	8360	247.5	22 x 85
255	OUT21	8338	137.5	22 x 85
256	OUT22	8316	247.5	22 x 85
257	OUT23	8294	137.5	22 x 85
258	OUT24	8272	247.5	22 x 85
259	OUT25	8250	137.5	22 x 85
260	OUT26	8228	247.5	22 x 85
261	OUT27	8206	137.5	22 x 85
262	OUT28	8184	247.5	22 x 85
263	OUT29	8162	137.5	22 x 85
264	OUT30	8140	247.5	22 x 85
265	OUT31	8118	137.5	22 x 85
266	OUT32	8096	247.5	22 x 85
267	OUT33	8074	137.5	22 x 85
268	OUT34	8052	247.5	22 x 85
269	OUT35	8030	137.5	22 x 85
270	OUT36	8008	247.5	22 x 85
271	OUT37	7986	137.5	22 x 85
272	OUT38	7964	247.5	22 x 85
273	OUT39	7942	137.5	22 x 85
274	OUT40	7920	247.5	22 x 85
275	OUT41	7898	137.5	22 x 85
276	OUT42	7876	247.5	22 x 85
277	OUT43	7854	137.5	22 x 85
278	OUT44	7832	247.5	22 x 85
279	OUT45	7810	137.5	22 x 85
280	OUT46	7788	247.5	22 x 85
281	OUT47	7766	137.5	22 x 85
282	OUT48	7744	247.5	22 x 85
283	OUT49	7722	137.5	22 x 85
284	OUT50	7700	247.5	22 x 85
285	OUT51	7678	137.5	22 x 85
286	OUT52	7656	247.5	22 x 85
287	OUT53	7634	137.5	22 x 85
288	OUT54	7612	247.5	22 x 85
289	OUT55	7590	137.5	22 x 85
290	OUT56	7568	247.5	22 x 85
291	OUT57	7546	137.5	22 x 85
292	OUT58	7524	247.5	22 x 85
293	OUT59	7502	137.5	22 x 85
294	OUT60	7480	247.5	22 x 85
295	OUT61	7458	137.5	22 x 85
296	OUT62	7436	247.5	22 x 85
297	OUT63	7414	137.5	22 x 85
298	OUT64	7392	247.5	22 x 85
299	OUT65	7370	137.5	22 x 85
300	OUT66	7348	247.5	22 x 85

No.	Name	X	Y	Bump size(μm)
301	OUT67	7326	137.5	22 x 85
302	OUT68	7304	247.5	22 x 85
303	OUT69	7282	137.5	22 x 85
304	OUT70	7260	247.5	22 x 85
305	OUT71	7238	137.5	22 x 85
306	OUT72	7216	247.5	22 x 85
307	OUT73	7194	137.5	22 x 85
308	OUT74	7172	247.5	22 x 85
309	OUT75	7150	137.5	22 x 85
310	OUT76	7128	247.5	22 x 85
311	OUT77	7106	137.5	22 x 85
312	OUT78	7084	247.5	22 x 85
313	OUT79	7062	137.5	22 x 85
314	OUT80	7040	247.5	22 x 85
315	OUT81	7018	137.5	22 x 85
316	OUT82	6996	247.5	22 x 85
317	OUT83	6974	137.5	22 x 85
318	OUT84	6952	247.5	22 x 85
319	OUT85	6930	137.5	22 x 85
320	OUT86	6908	247.5	22 x 85
321	OUT87	6886	137.5	22 x 85
322	OUT88	6864	247.5	22 x 85
323	OUT89	6842	137.5	22 x 85
324	OUT90	6820	247.5	22 x 85
325	OUT91	6798	137.5	22 x 85
326	OUT92	6776	247.5	22 x 85
327	OUT93	6754	137.5	22 x 85
328	OUT94	6732	247.5	22 x 85
329	OUT95	6710	137.5	22 x 85
330	OUT96	6688	247.5	22 x 85
331	OUT97	6666	137.5	22 x 85
332	OUT98	6644	247.5	22 x 85
333	OUT99	6622	137.5	22 x 85
334	OUT100	6600	247.5	22 x 85
335	OUT101	6578	137.5	22 x 85
336	OUT102	6556	247.5	22 x 85
337	OUT103	6534	137.5	22 x 85
338	OUT104	6512	247.5	22 x 85
339	OUT105	6490	137.5	22 x 85
340	OUT106	6468	247.5	22 x 85
341	OUT107	6446	137.5	22 x 85
342	OUT108	6424	247.5	22 x 85
343	OUT109	6402	137.5	22 x 85
344	OUT110	6380	247.5	22 x 85
345	OUT111	6358	137.5	22 x 85
346	OUT112	6336	247.5	22 x 85
347	OUT113	6314	137.5	22 x 85
348	OUT114	6292	247.5	22 x 85
349	OUT115	6270	137.5	22 x 85
350	OUT116	6248	247.5	22 x 85
351	OUT117	6226	137.5	22 x 85
352	OUT118	6204	247.5	22 x 85
353	OUT119	6182	137.5	22 x 85
354	OUT120	6160	247.5	22 x 85
355	OUT121	6138	137.5	22 x 85
356	OUT122	6116	247.5	22 x 85
357	OUT123	6094	137.5	22 x 85
358	OUT124	6072	247.5	22 x 85
359	OUT125	6050	137.5	22 x 85
360	OUT126	6028	247.5	22 x 85

No.	Name	X	Y	Bump size(μm)
361	OUT127	6006	137.5	22 x 85
362	OUT128	5984	247.5	22 x 85
363	OUT129	5962	137.5	22 x 85
364	OUT130	5940	247.5	22 x 85
365	OUT131	5918	137.5	22 x 85
366	OUT132	5896	247.5	22 x 85
367	OUT133	5874	137.5	22 x 85
368	OUT134	5852	247.5	22 x 85
369	OUT135	5830	137.5	22 x 85
370	OUT136	5808	247.5	22 x 85
371	OUT137	5786	137.5	22 x 85
372	OUT138	5764	247.5	22 x 85
373	OUT139	5742	137.5	22 x 85
374	OUT140	5720	247.5	22 x 85
375	OUT141	5698	137.5	22 x 85
376	OUT142	5676	247.5	22 x 85
377	OUT143	5654	137.5	22 x 85
378	OUT144	5632	247.5	22 x 85
379	OUT145	5610	137.5	22 x 85
380	OUT146	5588	247.5	22 x 85
381	OUT147	5566	137.5	22 x 85
382	OUT148	5544	247.5	22 x 85
383	OUT149	5522	137.5	22 x 85
384	OUT150	5500	247.5	22 x 85
385	OUT151	5478	137.5	22 x 85
386	OUT152	5456	247.5	22 x 85
387	OUT153	5434	137.5	22 x 85
388	OUT154	5412	247.5	22 x 85
389	OUT155	5390	137.5	22 x 85
390	OUT156	5368	247.5	22 x 85
391	OUT157	5346	137.5	22 x 85
392	OUT158	5324	247.5	22 x 85
393	OUT159	5302	137.5	22 x 85
394	OUT160	5280	247.5	22 x 85
395	OUT161	5258	137.5	22 x 85
396	OUT162	5236	247.5	22 x 85
397	OUT163	5214	137.5	22 x 85
398	OUT164	5192	247.5	22 x 85
399	OUT165	5170	137.5	22 x 85
400	OUT166	5148	247.5	22 x 85
401	OUT167	5126	137.5	22 x 85
402	OUT168	5104	247.5	22 x 85
403	OUT169	5082	137.5	22 x 85
404	OUT170	5060	247.5	22 x 85
405	OUT171	5038	137.5	22 x 85
406	OUT172	5016	247.5	22 x 85
407	OUT173	4994	137.5	22 x 85
408	OUT174	4972	247.5	22 x 85
409	OUT175	4950	137.5	22 x 85
410	OUT176	4928	247.5	22 x 85
411	OUT177	4906	137.5	22 x 85
412	OUT178	4884	247.5	22 x 85
413	OUT179	4862	137.5	22 x 85
414	OUT180	4840	247.5	22 x 85
415	OUT181	4818	137.5	22 x 85
416	OUT182	4796	247.5	22 x 85
417	OUT183	4774	137.5	22 x 85
418	OUT184	4752	247.5	22 x 85
419	OUT185	4730	137.5	22 x 85
420	OUT186	4708	247.5	22 x 85

No.	Name	X	Y	Bump size(μm)
421	OUT187	4686	137.5	22 x 85
422	OUT188	4664	247.5	22 x 85
423	OUT189	4642	137.5	22 x 85
424	OUT190	4620	247.5	22 x 85
425	OUT191	4598	137.5	22 x 85
426	OUT192	4576	247.5	22 x 85
427	OUT193	4554	137.5	22 x 85
428	OUT194	4532	247.5	22 x 85
429	OUT195	4510	137.5	22 x 85
430	OUT196	4488	247.5	22 x 85
431	OUT197	4466	137.5	22 x 85
432	OUT198	4444	247.5	22 x 85
433	OUT199	4422	137.5	22 x 85
434	OUT200	4400	247.5	22 x 85
435	OUT201	4378	137.5	22 x 85
436	OUT202	4356	247.5	22 x 85
437	OUT203	4334	137.5	22 x 85
438	OUT204	4312	247.5	22 x 85
439	OUT205	4290	137.5	22 x 85
440	OUT206	4268	247.5	22 x 85
441	OUT207	4246	137.5	22 x 85
442	OUT208	4224	247.5	22 x 85
443	OUT209	4202	137.5	22 x 85
444	OUT210	4180	247.5	22 x 85
445	OUT211	4158	137.5	22 x 85
446	OUT212	4136	247.5	22 x 85
447	OUT213	4114	137.5	22 x 85
448	OUT214	4092	247.5	22 x 85
449	OUT215	4070	137.5	22 x 85
450	OUT216	4048	247.5	22 x 85
451	OUT217	4026	137.5	22 x 85
452	OUT218	4004	247.5	22 x 85
453	OUT219	3982	137.5	22 x 85
454	OUT220	3960	247.5	22 x 85
455	OUT221	3938	137.5	22 x 85
456	OUT222	3916	247.5	22 x 85
457	OUT223	3894	137.5	22 x 85
458	OUT224	3872	247.5	22 x 85
459	OUT225	3850	137.5	22 x 85
460	OUT226	3828	247.5	22 x 85
461	OUT227	3806	137.5	22 x 85
462	OUT228	3784	247.5	22 x 85
463	OUT229	3762	137.5	22 x 85
464	OUT230	3740	247.5	22 x 85
465	OUT231	3718	137.5	22 x 85
466	OUT232	3696	247.5	22 x 85
467	OUT233	3674	137.5	22 x 85
468	OUT234	3652	247.5	22 x 85
469	OUT235	3630	137.5	22 x 85
470	OUT236	3608	247.5	22 x 85
471	OUT237	3586	137.5	22 x 85
472	OUT238	3564	247.5	22 x 85
473	OUT239	3542	137.5	22 x 85
474	OUT240	3520	247.5	22 x 85
475	OUT241	3498	137.5	22 x 85
476	OUT242	3476	247.5	22 x 85
477	OUT243	3454	137.5	22 x 85
478	OUT244	3432	247.5	22 x 85
479	OUT245	3410	137.5	22 x 85
480	OUT246	3388	247.5	22 x 85

No.	Name	X	Y	Bump size(μm)
481	OUT247	3366	137.5	22 x 85
482	OUT248	3344	247.5	22 x 85
483	OUT249	3322	137.5	22 x 85
484	OUT250	3300	247.5	22 x 85
485	OUT251	3278	137.5	22 x 85
486	OUT252	3256	247.5	22 x 85
487	OUT253	3234	137.5	22 x 85
488	OUT254	3212	247.5	22 x 85
489	OUT255	3190	137.5	22 x 85
490	OUT256	3168	247.5	22 x 85
491	OUT257	3146	137.5	22 x 85
492	OUT258	3124	247.5	22 x 85
493	OUT259	3102	137.5	22 x 85
494	OUT260	3080	247.5	22 x 85
495	OUT261	3058	137.5	22 x 85
496	OUT262	3036	247.5	22 x 85
497	OUT263	3014	137.5	22 x 85
498	OUT264	2992	247.5	22 x 85
499	OUT265	2970	137.5	22 x 85
500	OUT266	2948	247.5	22 x 85
501	OUT267	2926	137.5	22 x 85
502	OUT268	2904	247.5	22 x 85
503	OUT269	2882	137.5	22 x 85
504	OUT270	2860	247.5	22 x 85
505	OUT271	2838	137.5	22 x 85
506	OUT272	2816	247.5	22 x 85
507	OUT273	2794	137.5	22 x 85
508	OUT274	2772	247.5	22 x 85
509	OUT275	2750	137.5	22 x 85
510	OUT276	2728	247.5	22 x 85
511	OUT277	2706	137.5	22 x 85
512	OUT278	2684	247.5	22 x 85
513	OUT279	2662	137.5	22 x 85
514	OUT280	2640	247.5	22 x 85
515	OUT281	2618	137.5	22 x 85
516	OUT282	2596	247.5	22 x 85
517	OUT283	2574	137.5	22 x 85
518	OUT284	2552	247.5	22 x 85
519	OUT285	2530	137.5	22 x 85
520	OUT286	2508	247.5	22 x 85
521	OUT287	2486	137.5	22 x 85
522	OUT288	2464	247.5	22 x 85
523	OUT289	2442	137.5	22 x 85
524	OUT290	2420	247.5	22 x 85
525	OUT291	2398	137.5	22 x 85
526	OUT292	2376	247.5	22 x 85
527	OUT293	2354	137.5	22 x 85
528	OUT294	2332	247.5	22 x 85
529	OUT295	2310	137.5	22 x 85
530	OUT296	2288	247.5	22 x 85
531	OUT297	2266	137.5	22 x 85
532	OUT298	2244	247.5	22 x 85
533	OUT299	2222	137.5	22 x 85
534	OUT300	2200	247.5	22 x 85
535	OUT301	2178	137.5	22 x 85
536	OUT302	2156	247.5	22 x 85
537	OUT303	2134	137.5	22 x 85
538	OUT304	2112	247.5	22 x 85
539	OUT305	2090	137.5	22 x 85
540	OUT306	2068	247.5	22 x 85

No.	Name	X	Y	Bump size(μm)
541	OUT307	2046	137.5	22 x 85
542	OUT308	2024	247.5	22 x 85
543	OUT309	2002	137.5	22 x 85
544	OUT310	1980	247.5	22 x 85
545	OUT311	1958	137.5	22 x 85
546	OUT312	1936	247.5	22 x 85
547	OUT313	1914	137.5	22 x 85
548	OUT314	1892	247.5	22 x 85
549	OUT315	1870	137.5	22 x 85
550	OUT316	1848	247.5	22 x 85
551	OUT317	1826	137.5	22 x 85
552	OUT318	1804	247.5	22 x 85
553	OUT319	1782	137.5	22 x 85
554	OUT320	1760	247.5	22 x 85
555	OUT321	1738	137.5	22 x 85
556	OUT322	1716	247.5	22 x 85
557	OUT323	1694	137.5	22 x 85
558	OUT324	1672	247.5	22 x 85
559	OUT325	1650	137.5	22 x 85
560	OUT326	1628	247.5	22 x 85
561	OUT327	1606	137.5	22 x 85
562	OUT328	1584	247.5	22 x 85
563	OUT329	1562	137.5	22 x 85
564	OUT330	1540	247.5	22 x 85
565	OUT331	1518	137.5	22 x 85
566	OUT332	1496	247.5	22 x 85
567	OUT333	1474	137.5	22 x 85
568	OUT334	1452	247.5	22 x 85
569	OUT335	1430	137.5	22 x 85
570	OUT336	1408	247.5	22 x 85
571	OUT337	1386	137.5	22 x 85
572	OUT338	1364	247.5	22 x 85
573	OUT339	1342	137.5	22 x 85
574	OUT340	1320	247.5	22 x 85
575	OUT341	1298	137.5	22 x 85
576	OUT342	1276	247.5	22 x 85
577	OUT343	1254	137.5	22 x 85
578	OUT344	1232	247.5	22 x 85
579	OUT345	1210	137.5	22 x 85
580	OUT346	1188	247.5	22 x 85
581	OUT347	1166	137.5	22 x 85
582	OUT348	1144	247.5	22 x 85
583	OUT349	1122	137.5	22 x 85
584	OUT350	1100	247.5	22 x 85
585	OUT351	1078	137.5	22 x 85
586	OUT352	1056	247.5	22 x 85
587	OUT353	1034	137.5	22 x 85
588	OUT354	1012	247.5	22 x 85
589	OUT355	990	137.5	22 x 85
590	OUT356	968	247.5	22 x 85
591	OUT357	946	137.5	22 x 85
592	OUT358	924	247.5	22 x 85
593	OUT359	902	137.5	22 x 85
594	OUT360	880	247.5	22 x 85
595	OUT361	858	137.5	22 x 85
596	OUT362	836	247.5	22 x 85
597	OUT363	814	137.5	22 x 85
598	OUT364	792	247.5	22 x 85
599	OUT365	770	137.5	22 x 85
600	OUT366	748	247.5	22 x 85

No.	Name	X	Y	Bump size(μm)
601	OUT367	726	137.5	22 x 85
602	OUT368	704	247.5	22 x 85
603	OUT369	682	137.5	22 x 85
604	OUT370	660	247.5	22 x 85
605	OUT371	638	137.5	22 x 85
606	OUT372	616	247.5	22 x 85
607	OUT373	594	137.5	22 x 85
608	OUT374	572	247.5	22 x 85
609	OUT375	550	137.5	22 x 85
610	OUT376	528	247.5	22 x 85
611	OUT377	506	137.5	22 x 85
612	OUT378	484	247.5	22 x 85
613	OUT379	462	137.5	22 x 85
614	OUT380	440	247.5	22 x 85
615	OUT381	418	137.5	22 x 85
616	OUT382	396	247.5	22 x 85
617	OUT383	374	137.5	22 x 85
618	OUT384	352	247.5	22 x 85
619	OUT385	330	137.5	22 x 85
620	OUT386	308	247.5	22 x 85
621	OUT387	286	137.5	22 x 85
622	OUT388	264	247.5	22 x 85
623	OUT389	242	137.5	22 x 85
624	OUT390	220	247.5	22 x 85
625	OUT391	198	137.5	22 x 85
626	OUT392	176	247.5	22 x 85
627	OUT393	154	137.5	22 x 85
628	OUT394	132	247.5	22 x 85
629	OUT395	110	137.5	22 x 85
630	OUT396	88	247.5	22 x 85
631	OUT397	66	137.5	22 x 85
632	OUT398	44	247.5	22 x 85
633	OUT399	22	137.5	22 x 85
634	OUT400	0	247.5	22 x 85
635	OUT401	-22	137.5	22 x 85
636	OUT402	-44	247.5	22 x 85
637	OUT403	-66	137.5	22 x 85
638	OUT404	-88	247.5	22 x 85
639	OUT405	-110	137.5	22 x 85
640	OUT406	-132	247.5	22 x 85
641	OUT407	-154	137.5	22 x 85
642	OUT408	-176	247.5	22 x 85
643	OUT409	-198	137.5	22 x 85
644	OUT410	-220	247.5	22 x 85
645	OUT411	-242	137.5	22 x 85
646	OUT412	-264	247.5	22 x 85
647	OUT413	-286	137.5	22 x 85
648	OUT414	-308	247.5	22 x 85
649	OUT415	-330	137.5	22 x 85
650	OUT416	-352	247.5	22 x 85
651	OUT417	-374	137.5	22 x 85
652	OUT418	-396	247.5	22 x 85
653	OUT419	-418	137.5	22 x 85
654	OUT420	-440	247.5	22 x 85
655	OUT421	-462	137.5	22 x 85
656	OUT422	-484	247.5	22 x 85
657	OUT423	-506	137.5	22 x 85
658	OUT424	-528	247.5	22 x 85
659	OUT425	-550	137.5	22 x 85
660	OUT426	-572	247.5	22 x 85

No.	Name	X	Y	Bump size(μm)
661	OUT427	-594	137.5	22 x 85
662	OUT428	-616	247.5	22 x 85
663	OUT429	-638	137.5	22 x 85
664	OUT430	-660	247.5	22 x 85
665	OUT431	-682	137.5	22 x 85
666	OUT432	-704	247.5	22 x 85
667	OUT433	-726	137.5	22 x 85
668	OUT434	-748	247.5	22 x 85
669	OUT435	-770	137.5	22 x 85
670	OUT436	-792	247.5	22 x 85
671	OUT437	-814	137.5	22 x 85
672	OUT438	-836	247.5	22 x 85
673	OUT439	-858	137.5	22 x 85
674	OUT440	-880	247.5	22 x 85
675	OUT441	-902	137.5	22 x 85
676	OUT442	-924	247.5	22 x 85
677	OUT443	-946	137.5	22 x 85
678	OUT444	-968	247.5	22 x 85
679	OUT445	-990	137.5	22 x 85
680	OUT446	-1012	247.5	22 x 85
681	OUT447	-1034	137.5	22 x 85
682	OUT448	-1056	247.5	22 x 85
683	OUT449	-1078	137.5	22 x 85
684	OUT450	-1100	247.5	22 x 85
685	OUT451	-1122	137.5	22 x 85
686	OUT452	-1144	247.5	22 x 85
687	OUT453	-1166	137.5	22 x 85
688	OUT454	-1188	247.5	22 x 85
689	OUT455	-1210	137.5	22 x 85
690	OUT456	-1232	247.5	22 x 85
691	OUT457	-1254	137.5	22 x 85
692	OUT458	-1276	247.5	22 x 85
693	OUT459	-1298	137.5	22 x 85
694	OUT460	-1320	247.5	22 x 85
695	OUT461	-1342	137.5	22 x 85
696	OUT462	-1364	247.5	22 x 85
697	OUT463	-1386	137.5	22 x 85
698	OUT464	-1408	247.5	22 x 85
699	OUT465	-1430	137.5	22 x 85
700	OUT466	-1452	247.5	22 x 85
701	OUT467	-1474	137.5	22 x 85
702	OUT468	-1496	247.5	22 x 85
703	OUT469	-1518	137.5	22 x 85
704	OUT470	-1540	247.5	22 x 85
705	OUT471	-1562	137.5	22 x 85
706	OUT472	-1584	247.5	22 x 85
707	OUT473	-1606	137.5	22 x 85
708	OUT474	-1628	247.5	22 x 85
709	OUT475	-1650	137.5	22 x 85
710	OUT476	-1672	247.5	22 x 85
711	OUT477	-1694	137.5	22 x 85
712	OUT478	-1716	247.5	22 x 85
713	OUT479	-1738	137.5	22 x 85
714	OUT480	-1760	247.5	22 x 85
715	OUT481	-1782	137.5	22 x 85
716	OUT482	-1804	247.5	22 x 85
717	OUT483	-1826	137.5	22 x 85
718	OUT484	-1848	247.5	22 x 85
719	OUT485	-1870	137.5	22 x 85
720	OUT486	-1892	247.5	22 x 85

No.	Name	X	Y	Bump size(μm)
721	OUT487	-1914	137.5	22 x 85
722	OUT488	-1936	247.5	22 x 85
723	OUT489	-1958	137.5	22 x 85
724	OUT490	-1980	247.5	22 x 85
725	OUT491	-2002	137.5	22 x 85
726	OUT492	-2024	247.5	22 x 85
727	OUT493	-2046	137.5	22 x 85
728	OUT494	-2068	247.5	22 x 85
729	OUT495	-2090	137.5	22 x 85
730	OUT496	-2112	247.5	22 x 85
731	OUT497	-2134	137.5	22 x 85
732	OUT498	-2156	247.5	22 x 85
733	OUT499	-2178	137.5	22 x 85
734	OUT500	-2200	247.5	22 x 85
735	OUT501	-2222	137.5	22 x 85
736	OUT502	-2244	247.5	22 x 85
737	OUT503	-2266	137.5	22 x 85
738	OUT504	-2288	247.5	22 x 85
739	OUT505	-2310	137.5	22 x 85
740	OUT506	-2332	247.5	22 x 85
741	OUT507	-2354	137.5	22 x 85
742	OUT508	-2376	247.5	22 x 85
743	OUT509	-2398	137.5	22 x 85
744	OUT510	-2420	247.5	22 x 85
745	OUT511	-2442	137.5	22 x 85
746	OUT512	-2464	247.5	22 x 85
747	OUT513	-2486	137.5	22 x 85
748	OUT514	-2508	247.5	22 x 85
749	OUT515	-2530	137.5	22 x 85
750	OUT516	-2552	247.5	22 x 85
751	OUT517	-2574	137.5	22 x 85
752	OUT518	-2596	247.5	22 x 85
753	OUT519	-2618	137.5	22 x 85
754	OUT520	-2640	247.5	22 x 85
755	OUT521	-2662	137.5	22 x 85
756	OUT522	-2684	247.5	22 x 85
757	OUT523	-2706	137.5	22 x 85
758	OUT524	-2728	247.5	22 x 85
759	OUT525	-2750	137.5	22 x 85
760	OUT526	-2772	247.5	22 x 85
761	OUT527	-2794	137.5	22 x 85
762	OUT528	-2816	247.5	22 x 85
763	OUT529	-2838	137.5	22 x 85
764	OUT530	-2860	247.5	22 x 85
765	OUT531	-2882	137.5	22 x 85
766	OUT532	-2904	247.5	22 x 85
767	OUT533	-2926	137.5	22 x 85
768	OUT534	-2948	247.5	22 x 85
769	OUT535	-2970	137.5	22 x 85
770	OUT536	-2992	247.5	22 x 85
771	OUT537	-3014	137.5	22 x 85
772	OUT538	-3036	247.5	22 x 85
773	OUT539	-3058	137.5	22 x 85
774	OUT540	-3080	247.5	22 x 85
775	OUT541	-3102	137.5	22 x 85
776	OUT542	-3124	247.5	22 x 85
777	OUT543	-3146	137.5	22 x 85
778	OUT544	-3168	247.5	22 x 85
779	OUT545	-3190	137.5	22 x 85
780	OUT546	-3212	247.5	22 x 85

No.	Name	X	Y	Bump size(μm)
781	OUT547	-3234	137.5	22 x 85
782	OUT548	-3256	247.5	22 x 85
783	OUT549	-3278	137.5	22 x 85
784	OUT550	-3300	247.5	22 x 85
785	OUT551	-3322	137.5	22 x 85
786	OUT552	-3344	247.5	22 x 85
787	OUT553	-3366	137.5	22 x 85
788	OUT554	-3388	247.5	22 x 85
789	OUT555	-3410	137.5	22 x 85
790	OUT556	-3432	247.5	22 x 85
791	OUT557	-3454	137.5	22 x 85
792	OUT558	-3476	247.5	22 x 85
793	OUT559	-3498	137.5	22 x 85
794	OUT560	-3520	247.5	22 x 85
795	OUT561	-3542	137.5	22 x 85
796	OUT562	-3564	247.5	22 x 85
797	OUT563	-3586	137.5	22 x 85
798	OUT564	-3608	247.5	22 x 85
799	OUT565	-3630	137.5	22 x 85
800	OUT566	-3652	247.5	22 x 85
801	OUT567	-3674	137.5	22 x 85
802	OUT568	-3696	247.5	22 x 85
803	OUT569	-3718	137.5	22 x 85
804	OUT570	-3740	247.5	22 x 85
805	OUT571	-3762	137.5	22 x 85
806	OUT572	-3784	247.5	22 x 85
807	OUT573	-3806	137.5	22 x 85
808	OUT574	-3828	247.5	22 x 85
809	OUT575	-3850	137.5	22 x 85
810	OUT576	-3872	247.5	22 x 85
811	OUT577	-3894	137.5	22 x 85
812	OUT578	-3916	247.5	22 x 85
813	OUT579	-3938	137.5	22 x 85
814	OUT580	-3960	247.5	22 x 85
815	OUT581	-3982	137.5	22 x 85
816	OUT582	-4004	247.5	22 x 85
817	OUT583	-4026	137.5	22 x 85
818	OUT584	-4048	247.5	22 x 85
819	OUT585	-4070	137.5	22 x 85
820	OUT586	-4092	247.5	22 x 85
821	OUT587	-4114	137.5	22 x 85
822	OUT588	-4136	247.5	22 x 85
823	OUT589	-4158	137.5	22 x 85
824	OUT590	-4180	247.5	22 x 85
825	OUT591	-4202	137.5	22 x 85
826	OUT592	-4224	247.5	22 x 85
827	OUT593	-4246	137.5	22 x 85
828	OUT594	-4268	247.5	22 x 85
829	OUT595	-4290	137.5	22 x 85
830	OUT596	-4312	247.5	22 x 85
831	OUT597	-4334	137.5	22 x 85
832	OUT598	-4356	247.5	22 x 85
833	OUT599	-4378	137.5	22 x 85
834	OUT600	-4400	247.5	22 x 85
835	OUT601	-4422	137.5	22 x 85
836	OUT602	-4444	247.5	22 x 85
837	OUT603	-4466	137.5	22 x 85
838	OUT604	-4488	247.5	22 x 85
839	OUT605	-4510	137.5	22 x 85
840	OUT606	-4532	247.5	22 x 85

No.	Name	X	Y	Bump size(μm)
841	OUT607	-4554	137.5	22 x 85
842	OUT608	-4576	247.5	22 x 85
843	OUT609	-4598	137.5	22 x 85
844	OUT610	-4620	247.5	22 x 85
845	OUT611	-4642	137.5	22 x 85
846	OUT612	-4664	247.5	22 x 85
847	OUT613	-4686	137.5	22 x 85
848	OUT614	-4708	247.5	22 x 85
849	OUT615	-4730	137.5	22 x 85
850	OUT616	-4752	247.5	22 x 85
851	OUT617	-4774	137.5	22 x 85
852	OUT618	-4796	247.5	22 x 85
853	OUT619	-4818	137.5	22 x 85
854	OUT620	-4840	247.5	22 x 85
855	OUT621	-4862	137.5	22 x 85
856	OUT622	-4884	247.5	22 x 85
857	OUT623	-4906	137.5	22 x 85
858	OUT624	-4928	247.5	22 x 85
859	OUT625	-4950	137.5	22 x 85
860	OUT626	-4972	247.5	22 x 85
861	OUT627	-4994	137.5	22 x 85
862	OUT628	-5016	247.5	22 x 85
863	OUT629	-5038	137.5	22 x 85
864	OUT630	-5060	247.5	22 x 85
865	OUT631	-5082	137.5	22 x 85
866	OUT632	-5104	247.5	22 x 85
867	OUT633	-5126	137.5	22 x 85
868	OUT634	-5148	247.5	22 x 85
869	OUT635	-5170	137.5	22 x 85
870	OUT636	-5192	247.5	22 x 85
871	OUT637	-5214	137.5	22 x 85
872	OUT638	-5236	247.5	22 x 85
873	OUT639	-5258	137.5	22 x 85
874	OUT640	-5280	247.5	22 x 85
875	OUT641	-5302	137.5	22 x 85
876	OUT642	-5324	247.5	22 x 85
877	OUT643	-5346	137.5	22 x 85
878	OUT644	-5368	247.5	22 x 85
879	OUT645	-5390	137.5	22 x 85
880	OUT646	-5412	247.5	22 x 85
881	OUT647	-5434	137.5	22 x 85
882	OUT648	-5456	247.5	22 x 85
883	OUT649	-5478	137.5	22 x 85
884	OUT650	-5500	247.5	22 x 85
885	OUT651	-5522	137.5	22 x 85
886	OUT652	-5544	247.5	22 x 85
887	OUT653	-5566	137.5	22 x 85
888	OUT654	-5588	247.5	22 x 85
889	OUT655	-5610	137.5	22 x 85
890	OUT656	-5632	247.5	22 x 85
891	OUT657	-5654	137.5	22 x 85
892	OUT658	-5676	247.5	22 x 85
893	OUT659	-5698	137.5	22 x 85
894	OUT660	-5720	247.5	22 x 85
895	OUT661	-5742	137.5	22 x 85
896	OUT662	-5764	247.5	22 x 85
897	OUT663	-5786	137.5	22 x 85
898	OUT664	-5808	247.5	22 x 85
899	OUT665	-5830	137.5	22 x 85
900	OUT666	-5852	247.5	22 x 85

No.	Name	X	Y	Bump size(μm)
901	OUT667	-5874	137.5	22 x 85
902	OUT668	-5896	247.5	22 x 85
903	OUT669	-5918	137.5	22 x 85
904	OUT670	-5940	247.5	22 x 85
905	OUT671	-5962	137.5	22 x 85
906	OUT672	-5984	247.5	22 x 85
907	OUT673	-6006	137.5	22 x 85
908	OUT674	-6028	247.5	22 x 85
909	OUT675	-6050	137.5	22 x 85
910	OUT676	-6072	247.5	22 x 85
911	OUT677	-6094	137.5	22 x 85
912	OUT678	-6116	247.5	22 x 85
913	OUT679	-6138	137.5	22 x 85
914	OUT680	-6160	247.5	22 x 85
915	OUT681	-6182	137.5	22 x 85
916	OUT682	-6204	247.5	22 x 85
917	OUT683	-6226	137.5	22 x 85
918	OUT684	-6248	247.5	22 x 85
919	OUT685	-6270	137.5	22 x 85
920	OUT686	-6292	247.5	22 x 85
921	OUT687	-6314	137.5	22 x 85
922	OUT688	-6336	247.5	22 x 85
923	OUT689	-6358	137.5	22 x 85
924	OUT690	-6380	247.5	22 x 85
925	OUT691	-6402	137.5	22 x 85
926	OUT692	-6424	247.5	22 x 85
927	OUT693	-6446	137.5	22 x 85
928	OUT694	-6468	247.5	22 x 85
929	OUT695	-6490	137.5	22 x 85
930	OUT696	-6512	247.5	22 x 85
931	OUT697	-6534	137.5	22 x 85
932	OUT698	-6556	247.5	22 x 85
933	OUT699	-6578	137.5	22 x 85
934	OUT700	-6600	247.5	22 x 85
935	OUT701	-6622	137.5	22 x 85
936	OUT702	-6644	247.5	22 x 85
937	OUT703	-6666	137.5	22 x 85
938	OUT704	-6688	247.5	22 x 85
939	OUT705	-6710	137.5	22 x 85
940	OUT706	-6732	247.5	22 x 85
941	OUT707	-6754	137.5	22 x 85
942	OUT708	-6776	247.5	22 x 85
943	OUT709	-6798	137.5	22 x 85
944	OUT710	-6820	247.5	22 x 85
945	OUT711	-6842	137.5	22 x 85
946	OUT712	-6864	247.5	22 x 85
947	OUT713	-6886	137.5	22 x 85
948	OUT714	-6908	247.5	22 x 85
949	OUT715	-6930	137.5	22 x 85
950	OUT716	-6952	247.5	22 x 85
951	OUT717	-6974	137.5	22 x 85
952	OUT718	-6996	247.5	22 x 85
953	OUT719	-7018	137.5	22 x 85
954	OUT720	-7040	247.5	22 x 85
955	OUT721	-7062	137.5	22 x 85
956	OUT722	-7084	247.5	22 x 85
957	OUT723	-7106	137.5	22 x 85
958	OUT724	-7128	247.5	22 x 85
959	OUT725	-7150	137.5	22 x 85
960	OUT726	-7172	247.5	22 x 85

No.	Name	X	Y	Bump size(μm)
961	OUT727	-7194	137.5	22 x 85
962	OUT728	-7216	247.5	22 x 85
963	OUT729	-7238	137.5	22 x 85
964	OUT730	-7260	247.5	22 x 85
965	OUT731	-7282	137.5	22 x 85
966	OUT732	-7304	247.5	22 x 85
967	OUT733	-7326	137.5	22 x 85
968	OUT734	-7348	247.5	22 x 85
969	OUT735	-7370	137.5	22 x 85
970	OUT736	-7392	247.5	22 x 85
971	OUT737	-7414	137.5	22 x 85
972	OUT738	-7436	247.5	22 x 85
973	OUT739	-7458	137.5	22 x 85
974	OUT740	-7480	247.5	22 x 85
975	OUT741	-7502	137.5	22 x 85
976	OUT742	-7524	247.5	22 x 85
977	OUT743	-7546	137.5	22 x 85
978	OUT744	-7568	247.5	22 x 85
979	OUT745	-7590	137.5	22 x 85
980	OUT746	-7612	247.5	22 x 85
981	OUT747	-7634	137.5	22 x 85
982	OUT748	-7656	247.5	22 x 85
983	OUT749	-7678	137.5	22 x 85
984	OUT750	-7700	247.5	22 x 85
985	OUT751	-7722	137.5	22 x 85
986	OUT752	-7744	247.5	22 x 85
987	OUT753	-7766	137.5	22 x 85
988	OUT754	-7788	247.5	22 x 85
989	OUT755	-7810	137.5	22 x 85
990	OUT756	-7832	247.5	22 x 85
991	OUT757	-7854	137.5	22 x 85
992	OUT758	-7876	247.5	22 x 85
993	OUT759	-7898	137.5	22 x 85
994	OUT760	-7920	247.5	22 x 85
995	OUT761	-7942	137.5	22 x 85
996	OUT762	-7964	247.5	22 x 85
997	OUT763	-7986	137.5	22 x 85
998	OUT764	-8008	247.5	22 x 85
999	OUT765	-8030	137.5	22 x 85
1000	OUT766	-8052	247.5	22 x 85
1001	OUT767	-8074	137.5	22 x 85
1002	OUT768	-8096	247.5	22 x 85
1003	OUT769	-8118	137.5	22 x 85

No.	Name	X	Y	Bump size(μm)
1004	OUT770	-8140	247.5	22 x 85
1005	OUT771	-8162	137.5	22 x 85
1006	OUT772	-8184	247.5	22 x 85
1007	OUT773	-8206	137.5	22 x 85
1008	OUT774	-8228	247.5	22 x 85
1009	OUT775	-8250	137.5	22 x 85
1010	OUT776	-8272	247.5	22 x 85
1011	OUT777	-8294	137.5	22 x 85
1012	OUT778	-8316	247.5	22 x 85
1013	OUT779	-8338	137.5	22 x 85
1014	OUT780	-8360	247.5	22 x 85
1015	OUT781	-8382	137.5	22 x 85
1016	OUT782	-8404	247.5	22 x 85
1017	OUT783	-8426	137.5	22 x 85
1018	OUT784	-8448	247.5	22 x 85
1019	OUT785	-8470	137.5	22 x 85
1020	OUT786	-8492	247.5	22 x 85
1021	OUT787	-8514	137.5	22 x 85
1022	OUT788	-8536	247.5	22 x 85
1023	OUT789	-8558	137.5	22 x 85
1024	OUT790	-8580	247.5	22 x 85
1025	OUT791	-8602	137.5	22 x 85
1026	OUT792	-8624	247.5	22 x 85
1027	OUT793	-8646	137.5	22 x 85
1028	OUT794	-8668	247.5	22 x 85
1029	OUT795	-8690	137.5	22 x 85
1030	OUT796	-8712	247.5	22 x 85
1031	OUT797	-8734	137.5	22 x 85
1032	OUT798	-8756	247.5	22 x 85
1033	OUT799	-8778	137.5	22 x 85
1034	OUT800	-8800	247.5	22 x 85
1035	OUT801	-8822	137.5	22 x 85
1036	DUMMY2	-8844	247.5	22 x 85
1037	PATH1	-8910	235	50 x 110
1038	PATH1	-8980	235	50 x 110

9.5 Alignment mark center coordinates

Name	X	Y
L_AMK	-9085.0	120.0
R_AMK	9085.0	120.0

10. Ordering Information

Part No.	Package
HX8695-B02HPDxxx	PD: mean COG xxx: mean chip thickness (µm), (default 400µm)

11. Revision History

Version	Date	Description of Changes
01	2009/06/09	New setup
	2009/06/23	Modify VGL à VEE
	2009/09/11	L/R add pull low resistance

Himax Confidential
Do Not Copy