

# 90 Degree Hybrid 1.85–1.99 GHz



**HY19-12**

## Features

- Low Cost
- Low Profile
- Small SOIC-8 Package
- Tape & Reel

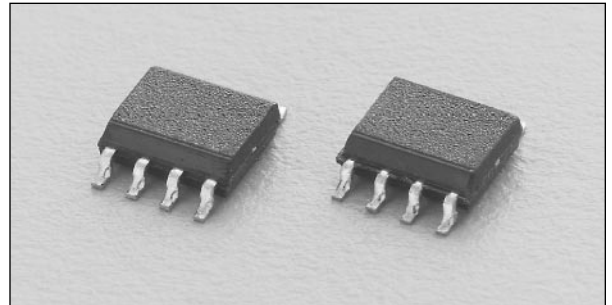

## Description

The HY19-12 is a 90 degree hybrid tuned for the 1.85–1.99 GHz band. The monolithic circuitry is 100% passive and offers low loss, high isolation and exceptional phase/amplitude balance. It is available in the SOIC-8 leaded surface mount package.

## Electrical Specifications at 25°C

Parameter	Min.	Typ.	Max.	Unit
Frequency	1.85		1.99	GHz
Insertion Loss <sup>1</sup>		.5	.6	dB
Isolation	17	20		dB
VSWR All Ports		1.3:1	1.5:1	
Amplitude Balance		±.5	±1.1	dB
Phase Balance		±1.0	±2.0	Deg.

1. Less 3 dB power split.

## Pin Out

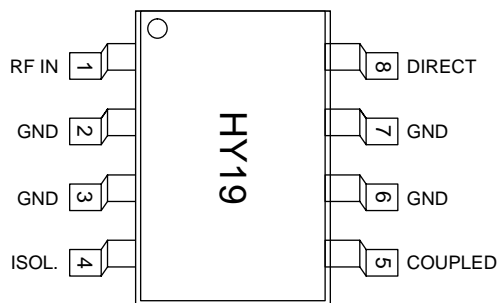

## Block Diagram

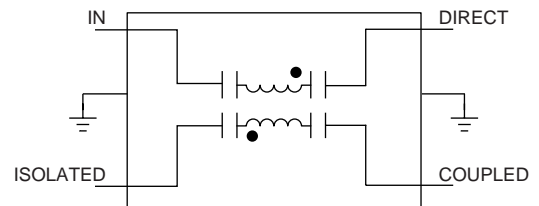

**Typical Performance Data**

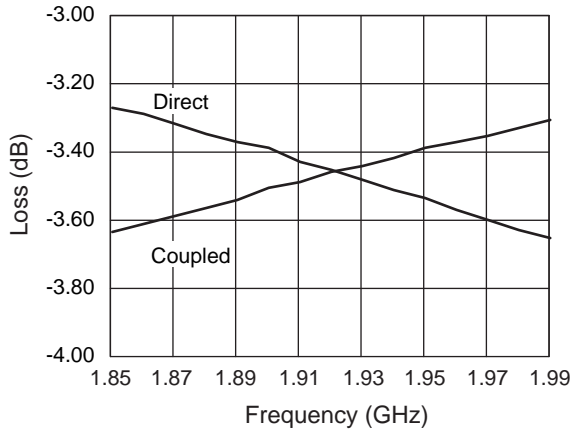

**Path Losses vs. Frequency**

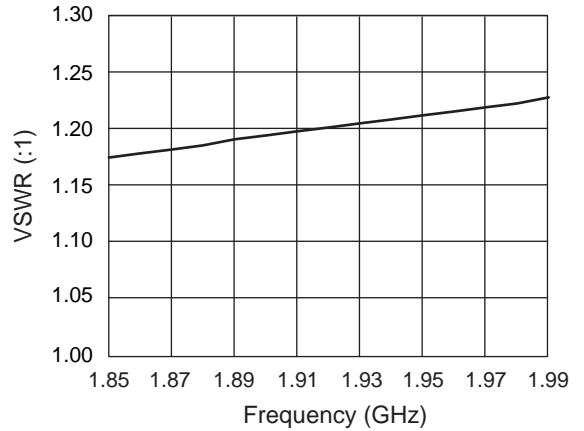

**Input VSWR vs. Frequency**

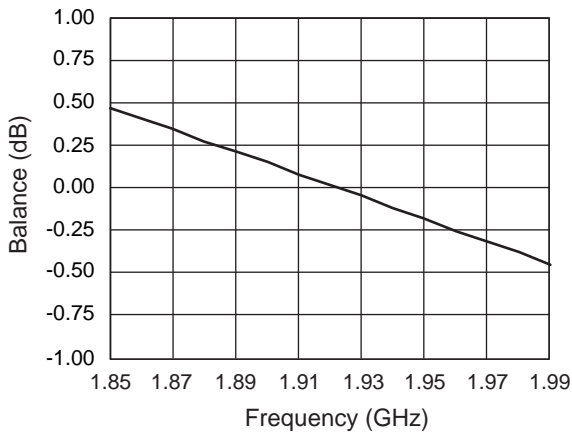

**Amplitude Balance vs. Frequency**

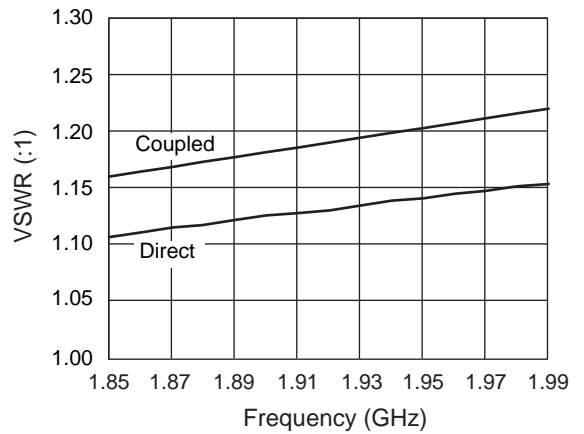

**Output VSWR vs. Frequency**

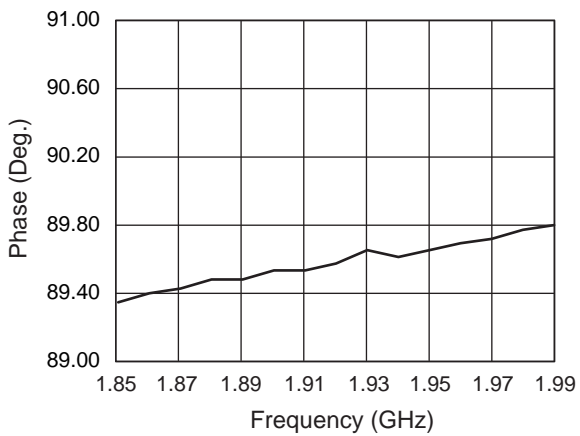

**Coupled - Direct Phase vs. Frequency**

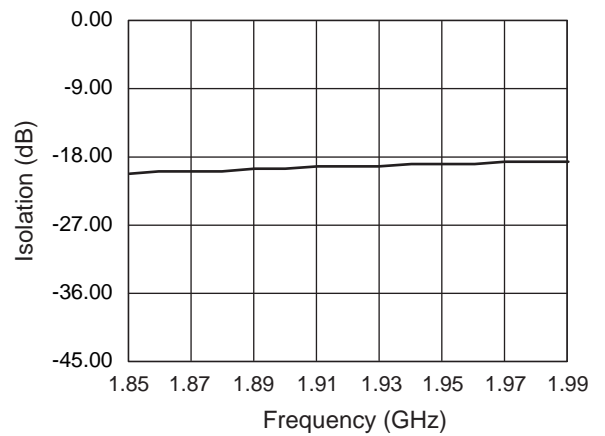

**Isolation vs. Frequency**

### Absolute Maximum Ratings

Characteristic	Value
Input Power <sup>1</sup>	+4 W
Operating Temperature	-40°C to +85°C
Storage Temperature	-65°C to +150°C
Electrostatic Discharge	+125 V

1. Exceeding these parameters may cause irreversible damage.

### Recommended Board Layout

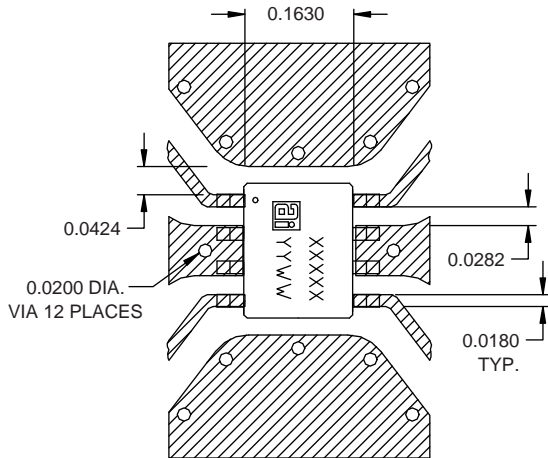

Materials 10 mil FR-4.  
Dimensions are in inches.

### SOIC-8

