

## N-Channel Enhancement Mode MOSFET

### Features

- 80V/100A  
 $R_{DS(ON)} = 6.6m\Omega$  (typ.) @  $V_{GS} = 10V$
- Avalanche Rated
- Reliable and Rugged
- Lead Free and Green Devices Available  
 (RoHS Compliant)

### Pin Description

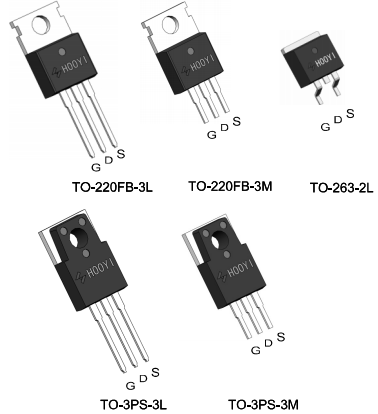



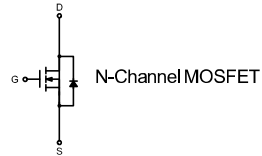

### Applications

- Power Management for Inverter Systems.



### Ordering and Marking Information

|   |   |  |   |
|---|---|--|---|
|  P<br>HY3008<br>YYXXJWW G  |  M<br>HY3008<br>YYXXJWW G  |  B<br>HY3008<br>YYXXJWW G | <b>Package Code</b><br>P : TO-220FB-3L    M : TO-220FB-3M<br>B : TO-263-2L     PS : TO-3PS-3L<br>PM : TO-3PS-3M |
|  PS<br>HY3008<br>YYXXJWW G |  PM<br>HY3008<br>YYXXJWW G |  | <b>Date Code</b> <b>Assembly Material</b><br>YYXX WW                      G : Lead Free Device                  |

Note: HOOYI lead-free products contain molding compounds/die attach materials and 100% matte tin plate termination finish; which are fully compliant with RoHS. HOOYI lead-free products meet or exceed the lead-free requirements of IPC/JEDEC J-STD-020D for MSL classification at lead-free peak reflow temperature. HOOYI defines "Green" to mean lead-free (RoHS compliant) and halogen free (Br or Cl does not exceed 900ppm by weight in homogeneous material and total of Br and Cl does not exceed 1500ppm by weight).

HOOYI reserves the right to make changes to improve reliability or manufacturability without notice, and advise customers to obtain the latest version of relevant information to verify before placing orders.

## Absolute Maximum Ratings

| Symbol   | Parameter                              | Rating                    | Unit               |                             |
|--|--|---------------------------|--------------------|-----------------------------|
| <b>Common Ratings</b> ( $T_C=25^{\circ}\text{C}$ Unless Otherwise Noted) |  |                           |                    |                             |
| $V_{DSS}$  | Drain-Source Voltage                   | 80                        | V                  |                             |
| $V_{GSS}$  | Gate-Source Voltage                    | $\pm 25$                  |                    |                             |
| $T_J$  | Maximum Junction Temperature           | 175                       | $^{\circ}\text{C}$ |                             |
| $T_{STG}$  | Storage Temperature Range              | 55 to 175                 | $^{\circ}\text{C}$ |                             |
| $I_S$  | Diode Continuous Forward Current       | $T_C=25^{\circ}\text{C}$  | 100                | A                           |
| <b>Mounted on Large Heat Sink</b>  |  |                           |                    |                             |
| $I_{DM}$   | Pulsed Drain Current *                 |                           | 400**              | A                           |
| $I_D$  | Continuous Drain Current               | $T_C=25^{\circ}\text{C}$  | 100                | A                           |
|  |  | $T_C=100^{\circ}\text{C}$ | 70                 |                             |
| $P_D$  | Maximum Power Dissipation              | $T_C=25^{\circ}\text{C}$  | 200                | W                           |
|  |  | $T_C=100^{\circ}\text{C}$ | 100                |                             |
| $R_{\theta JC}$  | Thermal Resistance-Junction to Case    |                           | 0.75               | $^{\circ}\text{C}/\text{W}$ |
| $R_{\theta JA}$  | Thermal Resistance-Junction to Ambient |                           | 62.5               |                             |
| <b>Avalanche Ratings</b>   |  |                           |                    |                             |
| $E_{AS}$   | Avalanche Energy, Single Pulsed        | $L=0.5\text{mH}$          | 530***             | mJ                          |

Note : \* Repetitive rating ; pulse width limited by junction temperature

\*\* Drain current is limited by junction temperature

\*\*\*  $V_D=64\text{V}$

## Electrical Characteristics ( $T_C = 25^{\circ}\text{C}$ Unless Otherwise Noted)

| Symbol                        | Parameter                        | Test Conditions   | HY3008 |      |           | Unit             |
|-------------------------------|----------------------------------|---|--------|------|-----------|------------------|
|                               |                                  |   | Min.   | Typ. | Max.      |                  |
| <b>Static Characteristics</b> |                                  |   |        |      |           |                  |
| $BV_{DSS}$                    | Drain-Source Breakdown Voltage   | $V_{GS}=0\text{V}, I_{DS}=250\mu\text{A}$               | 80     | -    | -         | V                |
| $I_{DSS}$                     | Zero Gate Voltage Drain Current  | $V_{DS}=80\text{V}, V_{GS}=0\text{V}$                   | -      | -    | 1         | $\mu\text{A}$    |
|                               |                                  | $T_J=85^{\circ}\text{C}$                                | -      | -    | 10        |                  |
| $V_{GS(th)}$                  | Gate Threshold Voltage           | $V_{DS}=V_{GS}, I_{DS}=250\mu\text{A}$                  | 2      | 3    | 4         | V                |
| $I_{GSS}$                     | Gate Leakage Current             | $V_{GS}=\pm 25\text{V}, V_{DS}=0\text{V}$               | -      | -    | $\pm 100$ | nA               |
| $R_{DS(ON)*}$                 | Drain-Source On-state Resistance | $V_{GS}=10\text{V}, I_{DS}=50\text{A}$                  | -      | 6.6  | 8.5       | $\text{m}\Omega$ |
| <b>Diode Characteristics</b>  |                                  |   |        |      |           |                  |
| $V_{SD}^*$                    | Diode Forward Voltage            | $I_{SD}=50\text{A}, V_{GS}=0\text{V}$                   | -      | 0.8  | 1         | V                |
| $t_{rr}$                      | Reverse Recovery Time            | $I_{SD}=50\text{A}, dI_{SD}/dt=100\text{A}/\mu\text{s}$ | -      | 62   | -         | ns               |
| $Q_{rr}$                      | Reverse Recovery Charge          |   | -      | 127  | -         | nC               |

## Electrical Characteristics (Cont.) (T<sub>c</sub> = 25°C Unless Otherwise Noted)

| Symbol                             | Parameter                    | Test Conditions  | HY3008 |      |      | Unit |
|------------------------------------|------------------------------|--|--------|------|------|------|
|                                    |                              |  | Min.   | Typ. | Max. |      |
| <b>Dynamic Characteristics</b>     |                              |  |        |      |      |      |
| R <sub>G</sub>                     | Gate Resistance              | V <sub>GS</sub> =0V, V <sub>DS</sub> =0V, F=1MHz   | -      | 1.0  | -    | Ω    |
| C <sub>iSS</sub>                   | Input Capacitance            | V <sub>GS</sub> =0V,<br>V <sub>DS</sub> =25V,<br>Frequency=1.0MHz                          | -      | 3150 | -    | pF   |
| C <sub>oss</sub>                   | Output Capacitance           |  | -      | 440  | -    |      |
| C <sub>rSS</sub>                   | Reverse Transfer Capacitance |  | -      | 199  | -    |      |
| t <sub>d(ON)</sub>                 | Turn-on Delay Time           | V <sub>DD</sub> =40V, R <sub>G</sub> = 5 Ω,<br>I <sub>DS</sub> =50A, V <sub>GS</sub> =10V, | -      | 23   | -    | ns   |
| T <sub>r</sub>                     | Turn-on Rise Time            |  | -      | 39   | -    |      |
| t <sub>d(OFF)</sub>                | Turn-off Delay Time          |  | -      | 55   | -    |      |
| T <sub>f</sub>                     | Turn-off Fall Time           |  | -      | 33   | -    |      |
| <b>Gate Charge Characteristics</b> |                              |  |        |      |      |      |
| Q <sub>g</sub>                     | Total Gate Charge            | V <sub>DS</sub> =64V, V <sub>GS</sub> =10V,<br>I <sub>DS</sub> =50A                        | -      | 67   | -    | nC   |
| Q <sub>gs</sub>                    | Gate-Source Charge           |  | -      | 14   | -    |      |
| Q <sub>gd</sub>                    | Gate-Drain Charge            |  | -      | 22   | -    |      |

Note \* : Pulse test ; pulse width ≤300μs, duty cycle ≤2%.

**Typical Operating Characteristics**

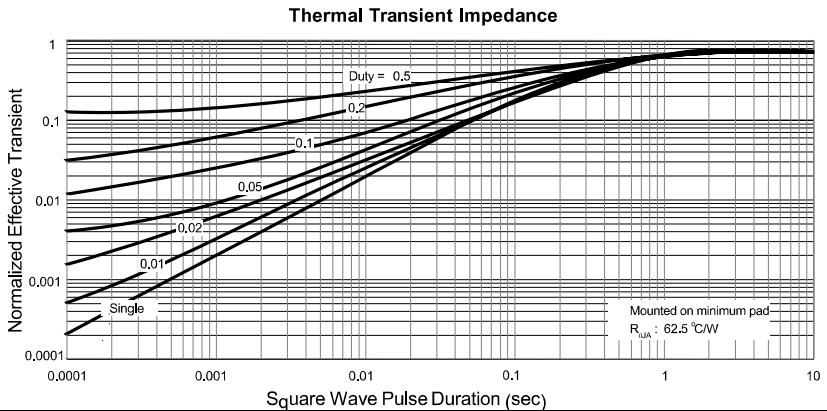
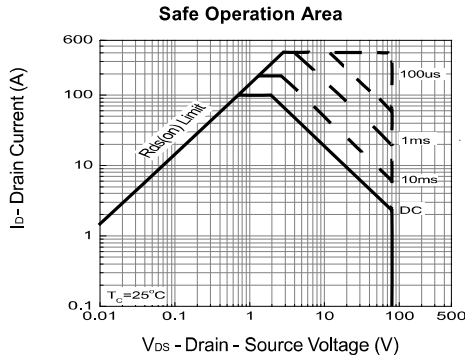
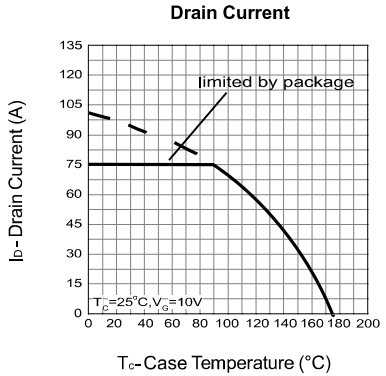
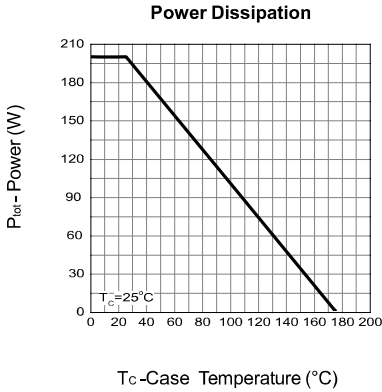

**Typical Operating Characteristics (Cont.)**

**Output Characteristics**

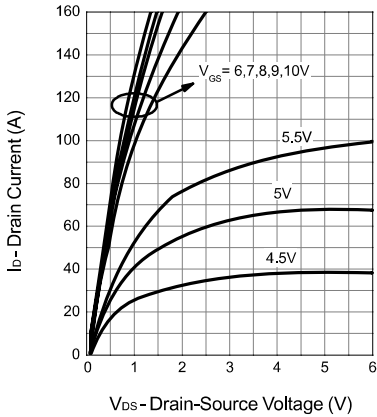

**Drain-Source On Resistance**

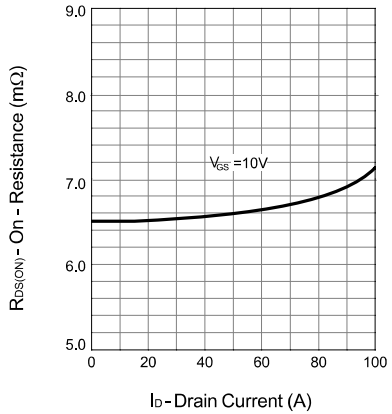

**Drain-Source On Resistance**

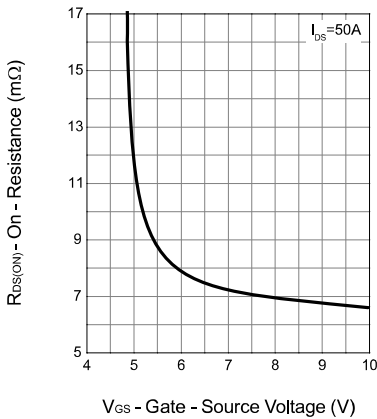

**Gate Threshold Voltage**

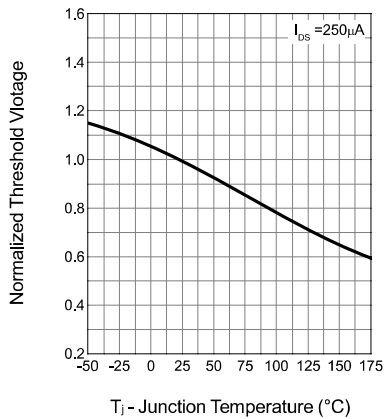

**Typical Operating Characteristics (Cont.)**

**Drain-Source On Resistance**

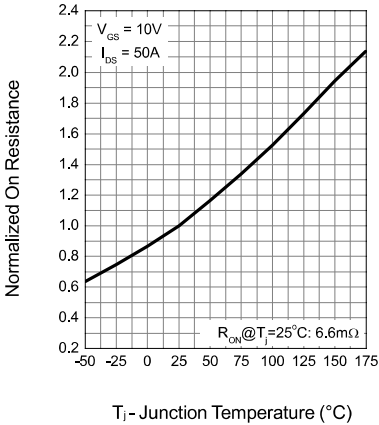

**Source-Drain Diode Forward**

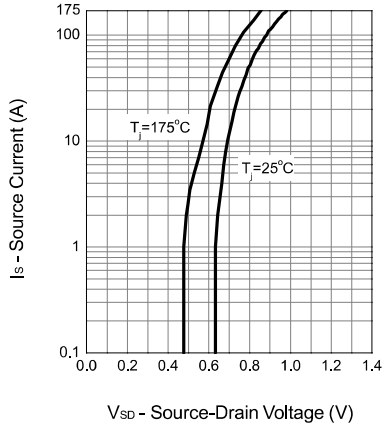

**Capacitance**

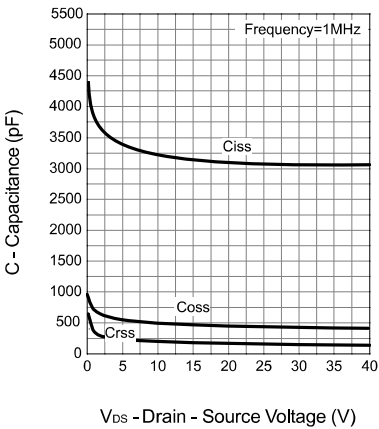

**Gate Charge**

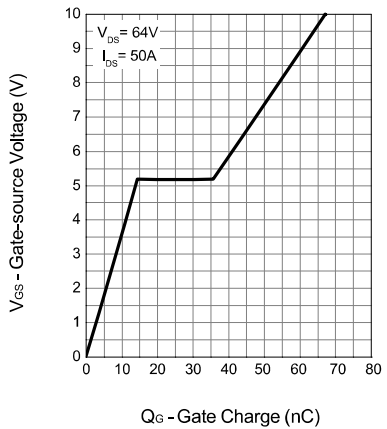

**Avalanche Test Circuit and Waveforms**

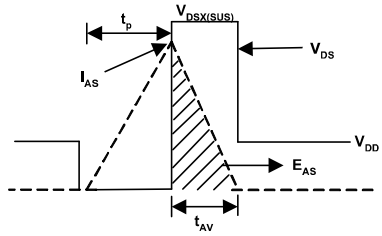
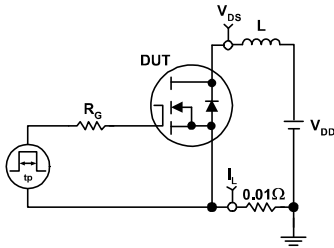

**Avalanche Test Circuit and Waveforms**

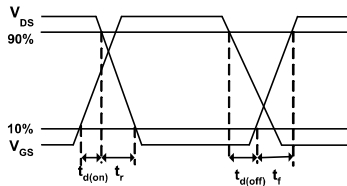
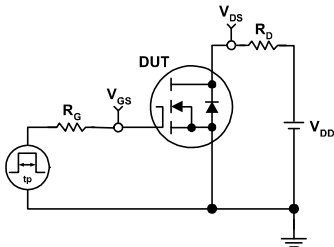

**Package Information**  
**TO-220FB-3L**

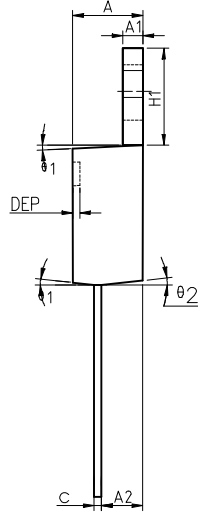
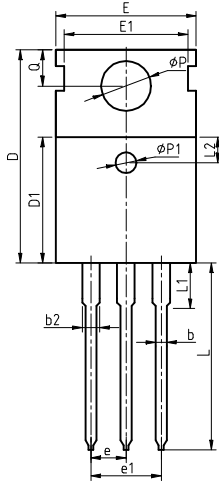

**COMMON DIMENSIONS**

| SYMBOL     | MIN   | NOM   | MAX   | MIN   | NOM   | MAX   |
|------------|-------|-------|-------|-------|-------|-------|
| A          | 4.40  | 4.57  | 4.70  | 0.173 | 0.180 | 0.185 |
| A1         | 1.27  | 1.30  | 1.33  | 0.050 | 0.051 | 0.052 |
| A2         | 2.35  | 2.40  | 2.50  | 0.093 | 0.094 | 0.098 |
| b          | 0.77  | 0.80  | 0.90  | 0.030 | 0.031 | 0.035 |
| b2         | 1.17  | 1.27  | 1.36  | 0.046 | 0.050 | 0.054 |
| c          | 0.48  | 0.50  | 0.56  | 0.019 | 0.020 | 0.022 |
| D          | 15.40 | 15.60 | 15.80 | 0.606 | 0.614 | 0.622 |
| D1         | 9.00  | 9.10  | 9.20  | 0.354 | 0.358 | 0.362 |
| DEP        | 0.05  | 0.10  | 0.20  | 0.002 | 0.004 | 0.008 |
| E          | 9.80  | 10.00 | 10.20 | 0.386 | 0.394 | 0.402 |
| E1         | -     | 8.70  | -     | -     | 0.343 | -     |
| E2         | 9.80  | 10.00 | 10.20 | 0.386 | 0.394 | 0.402 |
| e          | -     | 2.54  | BSC   | -     | 0.100 | BSC   |
| e1         | -     | 5.08  | BSC   | -     | 0.200 | BSC   |
| H1         | 6.40  | 6.50  | 6.60  | 0.252 | 0.256 | 0.260 |
| L          | 12.75 | 13.50 | 13.65 | 0.502 | 0.531 | 0.537 |
| L1         | -     | 3.10  | 3.30  | -     | 0.122 | 0.130 |
| L2         | -     | 2.50  | REF   | -     | 0.098 | REF   |
| P          | 3.50  | 3.60  | 3.63  | 0.138 | 0.142 | 0.143 |
| P1         | 3.50  | 3.60  | 3.63  | 0.138 | 0.142 | 0.143 |
| Q          | 2.73  | 2.80  | 2.87  | 0.107 | 0.110 | 0.113 |
| $\theta 1$ | 5°    | 7°    | 9°    | 5°    | 7°    | 9°    |
| $\theta 2$ | 1°    | 3°    | 5°    | 1°    | 3°    | 5°    |
| $\theta 3$ | 1°    | 3°    | 5°    | 1°    | 3°    | 5°    |



TO-220FB-3M

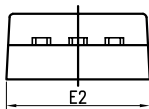
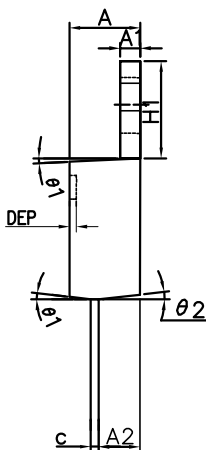
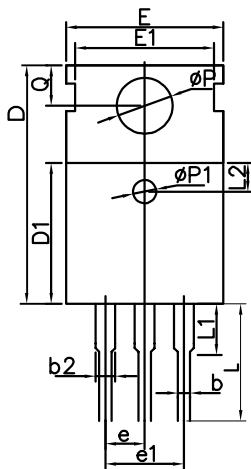

COMMON DIMENSIONS

| SYMBOL | MIN   | NOM   | MAX   | MIN   | NOM   | MAX   |
|--------|-------|-------|-------|-------|-------|-------|
| A      | 4.40  | 4.57  | 4.70  | 0.173 | 0.180 | 0.185 |
| A1     | 1.27  | 1.30  | 1.33  | 0.050 | 0.051 | 0.052 |
| A2     | 2.35  | 2.40  | 2.50  | 0.093 | 0.094 | 0.098 |
| b      | 0.77  | 0.80  | 0.90  | 0.030 | 0.031 | 0.035 |
| b2     | 1.17  | 1.27  | 1.36  | 0.046 | 0.050 | 0.054 |
| c      | 0.48  | 0.50  | 0.56  | 0.019 | 0.020 | 0.022 |
| D      | 15.40 | 15.60 | 15.80 | 0.606 | 0.614 | 0.622 |
| D1     | 9.00  | 9.10  | 9.20  | 0.354 | 0.358 | 0.362 |
| DEP    | 0.05  | 0.10  | 0.20  | 0.002 | 0.004 | 0.008 |
| E      | 9.80  | 10.00 | 10.20 | 0.386 | 0.394 | 0.402 |
| E1     | -     | 8.70  | -     | -     | 0.343 | -     |
| E2     | 9.80  | 10.00 | 10.20 | 0.386 | 0.394 | 0.402 |
| e      | -     | 2.54  | BSC   | -     | 0.100 | BSC   |
| e1     | -     | 5.08  | BSC   | -     | 0.200 | BSC   |
| H1     | 6.40  | 6.50  | 6.60  | 0.252 | 0.256 | 0.260 |
| L      | 7.25  | 7.40  | 7.55  | 0.285 | 0.291 | 0.297 |
| L1     | -     | 3.10  | 3.30  | -     | 0.122 | 0.130 |
| L2     | -     | 2.50  | REF   | -     | 0.098 | REF   |
| P      | 3.50  | 3.60  | 3.63  | 0.138 | 0.142 | 0.143 |
| P1     | 3.50  | 3.60  | 3.63  | 0.138 | 0.142 | 0.143 |
| Q      | 2.73  | 2.80  | 2.87  | 0.107 | 0.110 | 0.113 |
| θ 1    | 5°    | 7°    | 9°    | 5°    | 7°    | 9°    |
| θ 2    | 1°    | 3°    | 5°    | 1°    | 3°    | 5°    |

**TO-263-2L**

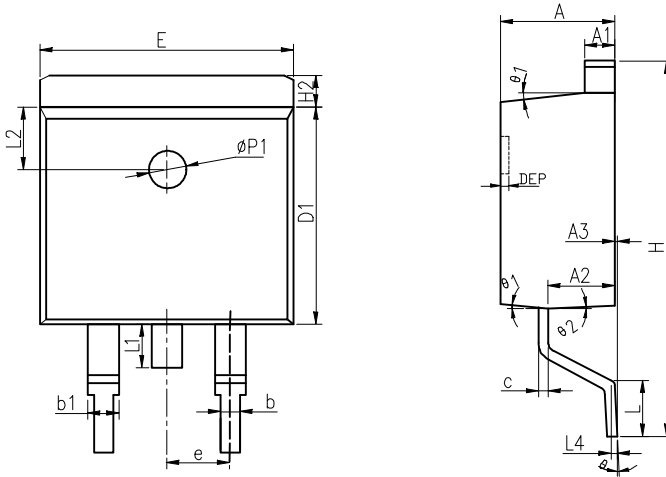

**COMMON DIMENSIONS**

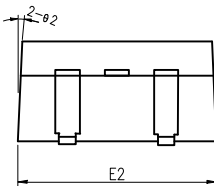

| SYMBOL | MM       |       |       | INCH      |       |       |
|--------|----------|-------|-------|-----------|-------|-------|
|        | MIN      | NOM   | MAX   | MIN       | NOM   | MAX   |
| A      | 4.40     | 4.57  | 4.70  | 0.173     | 0.180 | 0.185 |
| A1     | 1.22     | 1.27  | 1.32  | 0.048     | 0.050 | 0.052 |
| A2     | 2.59     | 2.69  | 2.79  | 0.102     | 0.106 | 0.110 |
| A3     | 0.00     | 0.10  | 0.20  | 0.000     | 0.004 | 0.008 |
| b      | 0.77     | 0.813 | 0.90  | 0.030     | 0.032 | 0.035 |
| b1     | 1.20     | 1.270 | 1.36  | 0.047     | 0.050 | 0.054 |
| c      | 0.34     | 0.381 | 0.47  | 0.013     | 0.015 | 0.019 |
| D1     | 8.60     | 8.70  | 8.80  | 0.339     | 0.343 | 0.346 |
| E      | 10.00    | 10.16 | 10.26 | 0.394     | 0.400 | 0.404 |
| E2     | 10.00    | 10.10 | 10.20 | 0.394     | 0.398 | 0.402 |
| e      | 2.54 BSC |       |       | 0.100 BSC |       |       |
| H      | 14.70    | 15.10 | 15.50 | 0.579     | 0.594 | 0.610 |
| H2     | 1.17     | 1.27  | 1.40  | 0.046     | 0.050 | 0.055 |
| L      | 2.00     | 2.30  | 2.60  | 0.079     | 0.091 | 0.102 |
| L1     | 1.45     | 1.55  | 1.70  | 0.057     | 0.061 | 0.067 |
| L2     | 2.50 REF |       |       | 0.098 REF |       |       |
| L4     | 0.25 BSC |       |       | 0.010 BSC |       |       |
|        | 0°       | 5°    | 8°    | 0°        | 5°    | 8°    |
| 1      | 5°       | 7°    | 9°    | 5°        | 7°    | 9°    |
| 2      | 1°       | 3°    | 5°    | 1°        | 3°    | 5°    |
| ΦP1    | 1.40     | 1.50  | 1.60  | 0.055     | 0.059 | 0.063 |
| DEP    | 0.05     | 0.10  | 0.20  | 0.002     | 0.004 | 0.008 |

**TO-3PS-3L**

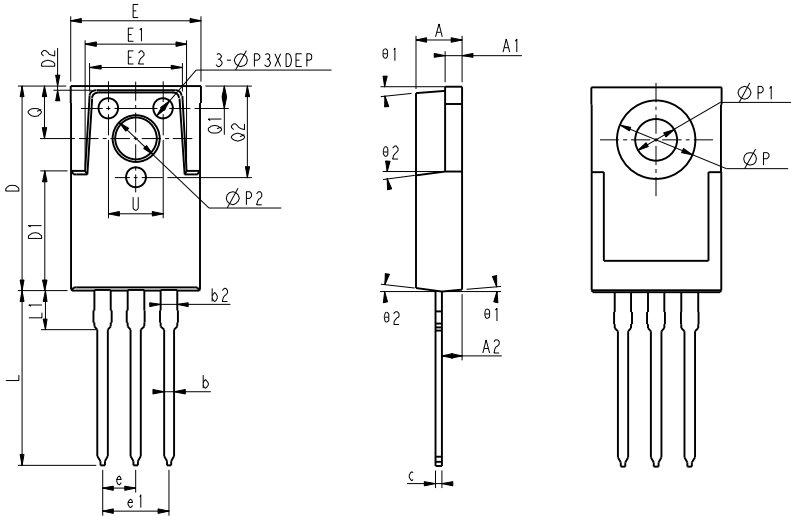

COMMON DIMENSIONS

| SYMBOL | MIN   | NOM   | MAX   |
|--------|-------|-------|-------|
| A      | 3.36  | 3.56  | 3.76  |
| A1     | 1.27  | 1.30  | 1.37  |
| A2     | 1.49  | 1.54  | 1.64  |
| b      | 0.77  | 0.80  | 0.90  |
| b2     | 1.17  | 1.27  | 1.36  |
| c      | 0.48  | 0.50  | 0.56  |
| D      | 15.50 | 15.70 | 15.90 |
| D1     | 9.10  | 9.20  | 9.30  |
| D2     |       | 0.30  | REF   |
| DEP    | 0.05  | 0.10  | 0.20  |
| E      | 9.88  | 10.00 | 10.20 |
| E1     | 7.80  | 8.00  | 8.20  |
| E2     | 6.90  | 7.10  | 7.30  |
| E3     | 9.90  | 10.00 | 10.10 |
| e      |       | 2.54  | BSC   |
| e1     |       | 5.08  | BSC   |
| L      | 13.25 | 13.40 | 13.55 |
| L1     | -     | 3.00  | 3.30  |
| P      |       | 6.00  | REF   |
| P1     |       | 3.20  | REF   |
| P2     |       | 3.57  | REF   |
| P3     | 1.40  | 1.50  | 1.60  |
| Q      | 3.93  | 4.00  | 4.07  |
| Q1     | 1.60  | 1.70  | 1.80  |
| Q2     | 6.80  | 7.00  | 7.20  |
| U      | 4.00  | 4.20  | 4.40  |
| Ø 1    | 3°    | 5°    | 7°    |
| Ø 2    | 5°    | 7°    | 9°    |
| Ø 3    | 1°    | 3°    | 5°    |

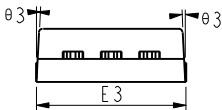

**TO-3PS-3M**

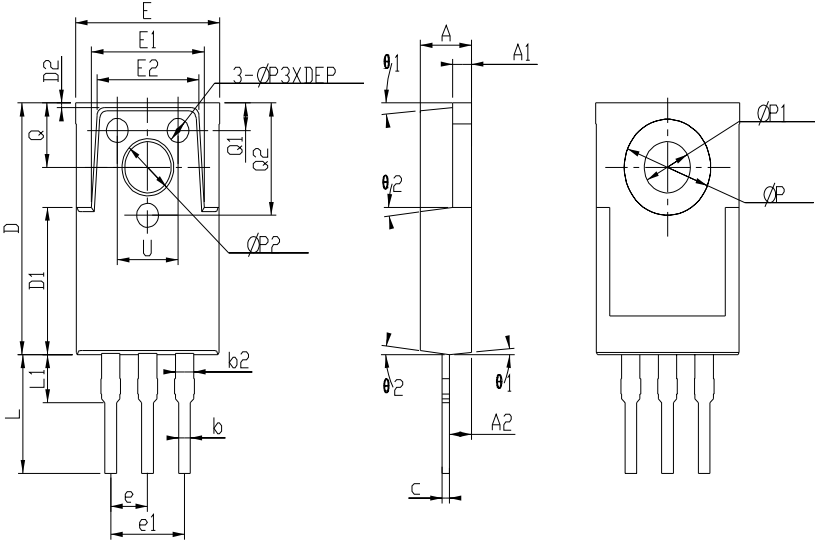

COMMON DIMENSIONS

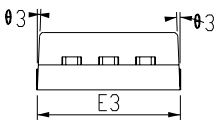

| SYMBOL | MIN   | NOM   | MAX   |
|--------|-------|-------|-------|
| A      | 3.36  | 3.56  | 3.76  |
| A1     | 1.27  | 1.30  | 1.37  |
| A2     | 1.49  | 1.54  | 1.64  |
| b      | 0.77  | 0.80  | 0.90  |
| b2     | 1.17  | 1.27  | 1.36  |
| c      | 0.48  | 0.50  | 0.56  |
| D      | 15.50 | 15.70 | 15.90 |
| D1     | 9.10  | 9.20  | 9.30  |
| D2     |       | 0.30  | REF   |
| DEP    | 0.05  | 0.10  | 0.20  |
| E      | 9.88  | 10.00 | 10.20 |
| E1     | 7.80  | 8.00  | 8.20  |
| E2     | 6.90  | 7.10  | 7.30  |
| E3     | 9.90  | 10.00 | 10.10 |
| e      |       | 2.54  | BSC   |
| e1     |       | 5.08  | BSC   |
| L      | 7.25  | 7.40  | 7.55  |
| L1     | -     | 3.00  | 3.30  |
| P      |       | 6.00  | REF   |
| P1     |       | 3.20  | REF   |
| P2     |       | 3.57  | REF   |
| P3     | 1.40  | 1.50  | 1.60  |
| Q      | 3.93  | 4.00  | 4.07  |
| Q1     | 1.60  | 1.70  | 1.80  |
| Q2     | 6.80  | 7.00  | 7.20  |
| U      | 4.00  | 4.20  | 4.40  |
| Ø1     | 3°    | 5°    | 7°    |
| Ø2     | 5°    | 7°    | 9°    |
| Ø3     | 1°    | 3°    | 5°    |

**Devices Per Unit**

| Package Type | Unit | Quantity |
|--------------|------|----------|
| TO-220FB-3L  | Tube | 50       |
| TO-220FB-3M  | Tube | 50       |
| TO-263-2L    | Tube | 50       |
| TO-3PS-3L    | Tube | 50       |
| TO-3PS-3M    | Tube | 50       |

**Classification Profile**

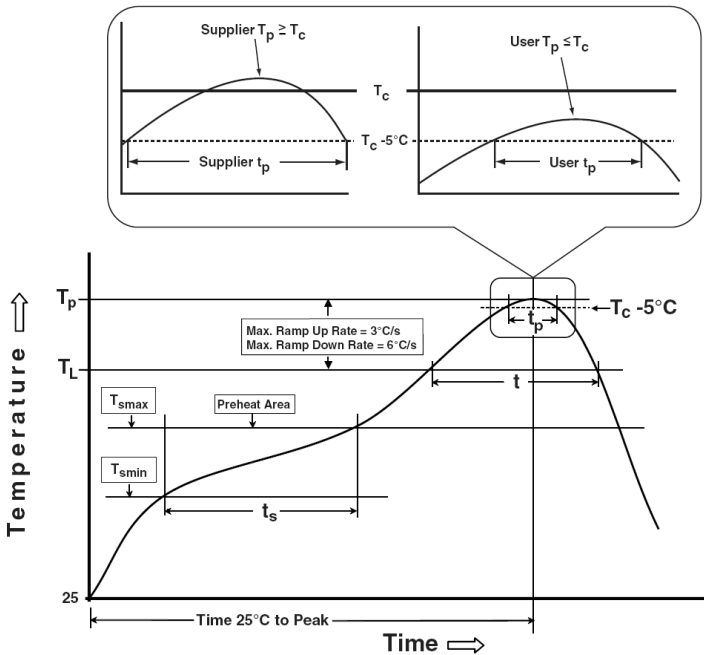

## Classification Reflow Profiles

| Profile Feature   | Sn-Pb Eutectic Assembly            | Pb-Free Assembly                   |
|---|------------------------------------|------------------------------------|
| <b>Preheat &amp; Soak</b>   |                                    |                                    |
| Temperature min ( $T_{smin}$ )  | 100 °C                             | 150 °C                             |
| Temperature max ( $T_{smax}$ )  | 150 °C                             | 200 °C                             |
| Time ( $T_{smin}$ to $T_{smax}$ ) ( $t_s$ )   | 60-120 seconds                     | 60-120 seconds                     |
| Average ramp-up rate ( $T_{smax}$ to $T_P$ )  | 3 °C/second max.                   | 3°C/second max.                    |
| Liquidous temperature ( $T_L$ )   | 183 °C                             | 217 °C                             |
| Time at liquidous ( $t_L$ )   | 60-150 seconds                     | 60-150 seconds                     |
| Peak package body Temperature ( $T_P$ )*  | See Classification Temp in table 1 | See Classification Temp in table 2 |
| Time ( $t_P$ )** within 5°C of the specified classification temperature ( $T_C$ )   | 20** seconds                       | 30** seconds                       |
| Average ramp-down rate ( $T_P$ to $T_{smax}$ )  | 6 °C/second max.                   | 6 °C/second max.                   |
| Time 25°C to peak temperature   | 6 minutes max.                     | 8 minutes max.                     |
| * Tolerance for peak profile Temperature ( $T_P$ ) is defined as a supplier minimum and a user maximum.<br>** Tolerance for time at peak profile temperature ( $t_P$ ) is defined as a supplier minimum and a user maximum. |                                    |                                    |

Table 1. SnPb Eutectic Process – Classification Temperatures ( $T_C$ )

| Package Thickness | Volume mm <sup>3</sup><br><350 | Volume mm <sup>3</sup><br>≥350 |
|-------------------|--------------------------------|--------------------------------|
| <2.5 mm           | 235 °C                         | 220 °C                         |
| ≥2.5 mm           | 220 °C                         | 220 °C                         |

Table 2. Pb-free Process – Classification Temperatures ( $T_C$ )

| Package Thickness | Volume mm <sup>3</sup><br><350 | Volume mm <sup>3</sup><br>350-2000 | Volume mm <sup>3</sup><br>>2000 |
|-------------------|--------------------------------|------------------------------------|---------------------------------|
| <1.6 mm           | 260 °C                         | 260 °C                             | 260 °C                          |
| 1.6 mm – 2.5 mm   | 260 °C                         | 250 °C                             | 245 °C                          |
| ≥2.5 mm           | 250 °C                         | 245 °C                             | 245 °C                          |

## Reliability Test Program

| Test item     | Method        | Description                  |
|---------------|---------------|------------------------------|
| SOLDERABILITY | JESD-22, B102 | 5 Sec, 245°C                 |
| HOLT          | JESD-22, A108 | 1000 Hrs, Bias @ 125°C       |
| PCT           | JESD-22, A102 | 168 Hrs, 100%RH, 2atm, 121°C |
| TCT           | JESD-22, A104 | 500 Cycles, -65°C~150°C      |