

### DESCRIPTION

The HY514260 is the new generation and fast dynamic RAM organized 262,144 x 16-bit configuration employing advanced submicron CMOS process technology and advanced circuit design technique to achieve fast access time. Independent read and write of upper and lower byte is controlled by 2 separate CAS inputs.

Refresh control is provided through RAS-only, CAS-before-RAS, hidden refresh and self refresh modes. The HY514260 conforms to JEDEC pinpoint standards and is available in industry standard 400mil 40pin SOJ and 40/44pin TSOP-II and reverse TSOP-II packages.

### FEATURES

- Low power dissipation
  - Max. battery back-up 1.65mW (SL-part)
  - Max. CMOS standby 1.1mW (SL-part) 5.5mW
  - Max. TTL standby 11.0mW
  - Max. Self refresh 1.65mW (SL-part)

Max. operating

Speed	Power
60	825mW
70	770mW
80	660mW

- Single power supply of 5V ± 10%
- TTL compatible inputs and outputs
- Fast access time

Speed	tRAC	tCAC	tpc
60	60ns	20ns	40ns
70	70ns	20ns	45ns
80	80ns	20ns	50ns

- Fast page mode operation
- 2 CAS inputs for upper and lower byte control
- Read-Modify-Write capability
- CAS-before-RAS, RAS-only, Hidden refresh and Self refresh
- 512 refresh cycles / 128ms (SL-part)  
512 refresh cycles / 8ms

### PIN DESCRIPTION

RAS	Row Address Strobe
LCAS, UCAS	Column Address Strobe
WE	Write Enable
OE	Output Enable
A0-A8	Address Input
DQ0-DQ15	Data Input/Output
Vcc	Power (+5V)
Vss	Ground

### PIN CONNECTION

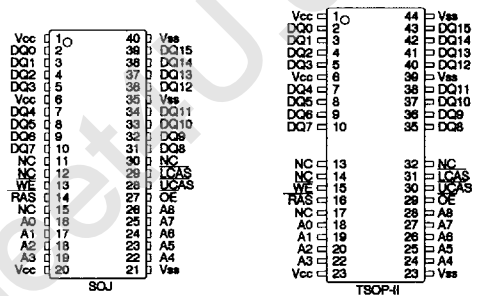

### BLOCK DIAGRAM

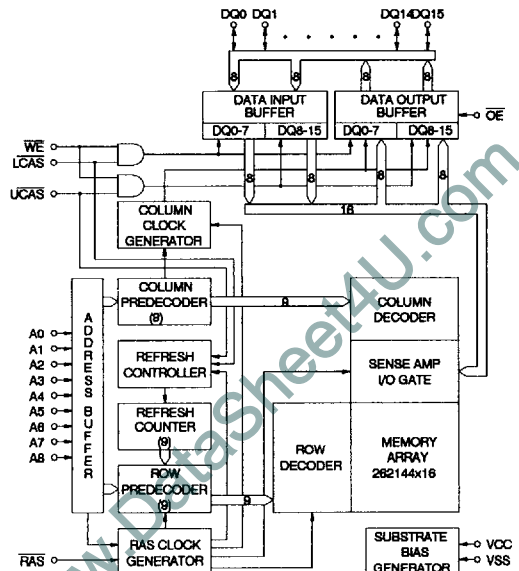

**ABSOLUTE MAXIMUM RATINGS**

SYMBOL	PARAMETER	RATING	UNIT
TA	Ambient Temperature	0 to 70	°C
TSTG	Storage Temperature	-55 to 150	°C
VIN, VOUT	Voltage on Any Pin Relative to Vss	-1.0 to 7.0	V
VCC	Voltage on VCC Relative to Vss	-1.0 to 7.0	V
Ios	Short Circuit Output Current	50	mA
PD	Power Dissipation	1.0	W
TSOLDER	Soldering Temperature•Time	260•10	°C•sec

NOTE : Operation at or above Absolute Maximum Ratings can adversely affect device reliability.

**RECOMMENDED DC OPERATING CONDITIONS**

(TA=0°C to 70°C)

SYMBOL	PARAMETER	MIN.	TYP.	MAX.	UNIT
VCC	Supply Voltage	4.5	5.0	5.5	V
VIH	Input High Voltage	2.4	-	VCC + 1.0	V
VIL	Input Low Voltage	-1.0	-	0.8	V

NOTE : All voltages are referenced to Vss.

**DC CHARACTERISTICS**

(TA=0°C to 70°C, VCC=5V±10%, VSS=0V, unless otherwise noted.)

SYMBOL	PARAMETER	TEST CONDITIONS	SPEED/ POWER	MIN.	MAX.	UNIT	NOTE
I <sub>LI</sub>	Input Leakage Current (Any Input Pins)	V <sub>SS</sub> ≤ V <sub>IN</sub> ≤ 6.5V, All other pins not under test = V <sub>SS</sub>		-10	10	μA	
I <sub>LO</sub>	Output Leakage Current (High Impedance State)	V <sub>SS</sub> ≤ V <sub>OUT</sub> ≤ 5.5V, RAS & CAS at V <sub>IH</sub>		-10	10	μA	
I <sub>CC1</sub>	V <sub>CC</sub> Supply Current, Operating	t <sub>RC</sub> = t <sub>RC</sub> (min.)	60	-	150	mA	1,2,3
			70	-	140		
			80	-	120		
I <sub>CC2</sub>	V <sub>CC</sub> Supply Current, TTL Standby	RAS & CAS at V <sub>IH</sub> , other inputs ≥ V <sub>SS</sub>		-	2	mA	
I <sub>CC3</sub>	V <sub>CC</sub> Supply Current, RAS-only refresh	t <sub>RC</sub> = t <sub>RC</sub> (min.)	60	-	150	mA	1,3
			70	-	140		
			80	-	120		
I <sub>CC4</sub>	V <sub>CC</sub> Supply Current, Fast Page mode	t <sub>PC</sub> = t <sub>PC</sub> (min.)	60	-	120	mA	1,2,3
			70	-	110		
			80	-	90		
I <sub>CC5</sub>	V <sub>CC</sub> Supply Current, CMOS Standby	RAS & CAS ≥ V <sub>CC</sub> -0.2V	SL-part	-	1	mA	5
				-	0.2		
I <sub>CC6</sub>	V <sub>CC</sub> Supply Current, CAS-before-RAS refresh	t <sub>RC</sub> = t <sub>RC</sub> (min.)	60	-	150	mA	1,3
			70	-	140		
			80	-	120		
I <sub>CC7</sub>	V <sub>CC</sub> Supply Current, Battery Back Up (SL-part only)	t <sub>RC</sub> = 250μs, t <sub>RAS</sub> ≤ 1μs CAS = CBR cycling or 0.2V OE & WE = V <sub>CC</sub> -0.2V, A0-A8 = V <sub>CC</sub> -0.2V or 0.2V DQ0-DQ15 = 0.2V, V <sub>CC</sub> -0.2V or open		-	300	μA	1,4,5
I <sub>CC8</sub>	V <sub>CC</sub> Supply Current, Self refresh (SL-part only)	RAS & CAS ≤ 0.2V other pins same as I <sub>CC7</sub>		-	300	μA	5
V <sub>OL</sub>	Output Low Voltage	I <sub>OL</sub> = 4.2mA		-	0.4	V	
V <sub>OH</sub>	Output High Voltage	I <sub>OH</sub> = -5mA		2.4	-	V	

**NOTE :**

1. I<sub>CC1</sub>, I<sub>CC3</sub>, I<sub>CC4</sub>, I<sub>CC6</sub> and I<sub>CC7</sub> depend on cycle rate.
2. I<sub>CC1</sub> and I<sub>CC4</sub> depend on output loading. Specified values are obtained with the output open.
3. It depends on user whether column address is changed or not at least once while RAS = V<sub>IL</sub> and CAS = V<sub>IH</sub>.
4. Only t<sub>RAS</sub>(max.) = 1μs is applied to refresh of battery backup but t<sub>RAS</sub>(max.) = 10μs is applied to normal functional operation.
5. I<sub>CC5</sub>(max.) = 0.2mA, I<sub>CC7</sub> and I<sub>CC8</sub> are applied to SL-parts only (HY514260SLJC, HY514260SLTC and HY514260SLRC).

**AC CHARACTERISTICS**

(TA=0°C to 70°C, VCC=5V±10%, VSS=0V, unless otherwise noted.) NOTE : 1, 2, 3, 13

#	SYMBOL	PARAMETER	HY514260JC/TC/RC/SLJC/SLTC/SLRC						UNIT	NOTE
			-60		-70		-80			
			MIN.	MAX.	MIN.	MAX.	MIN.	MAX.		
1	tRC	Random Read or Write Cycle Time	120	-	130	-	150	-	ns	
2	tRWC	Read-Modify-Write Cycle Time	175	-	180	-	200	-	ns	
3	tPC	Fast Page Mode Cycle Time	45	-	45	-	50	-	ns	
4	tPRWC	Fast Page Mode Read-Modify-Write Cycle Time	95	-	95	-	100	-	ns	
5	tRAC	Access Time from RAS	-	60	-	70	-	80	ns	4,9,10
6	tCAC	Access Time from CAS	-	20	-	20	-	20	ns	4,9
7	tAA	Access Time from Column Address	-	30	-	35	-	40	ns	4,10
8	tCPA	Access Time from Column Precharge	-	40	-	40	-	45	ns	4,15
9	tCLZ	CAS to Output Low Impedance	0	-	0	-	0	-	ns	4
10	tOFF	Output Buffer Turn-off Delay	0	15	0	15	0	15	ns	5
11	tT	Transition Time (Rise and Fall)	3	50	3	50	3	50	ns	3
12	tRP	RAS Precharge Time	50	-	50	-	60	-	ns	
13	tRAS	RAS Pulse Width	60	10K	70	10K	80	10K	ns	
14	tRASP	RAS Pulse Width (Fast Page Mode)	60	100K	70	100K	80	100K	ns	
15	tRSH	RAS Hold Time	20	-	20	-	20	-	ns	
16	tCSH	CAS Hold Time	60	-	70	-	80	-	ns	
17	tCAS	CAS Pulse Width	20	10K	20	10K	20	10K	ns	
18	tRCD	RAS to CAS Delay	20	40	20	50	20	55	ns	9
19	tRAD	RAS to Column Address Delay Time	15	30	15	35	15	40	ns	10
20	tCRP	CAS to RAS Precharge Time	5	-	5	-	5	-	ns	15
21	tCP	CAS Precharge Time	10	-	10	-	10	-	ns	17
22	tASR	Row Address Set-up Time	0	-	0	-	0	-	ns	
23	tRAH	Row Address Hold Time	10	-	10	-	10	-	ns	
24	tASC	Column Address Set-up Time	0	-	0	-	0	-	ns	14
25	tCAH	Column Address Hold Time	15	-	15	-	15	-	ns	14
26	tAR	Column Address Hold Time from RAS	50	-	55	-	60	-	ns	
27	tRAL	Column Address to RAS Lead Time	30	-	35	-	40	-	ns	
28	tRCS	Read Command Set-up Time	0	-	0	-	0	-	ns	14
29	tRCH	Read Command Hold Time Referenced to CAS	0	-	0	-	0	-	ns	6,14
30	tRRH	Read Command Hold Time Referenced to RAS	0	-	0	-	0	-	ns	6
31	tWCH	Write Command Hold Time	15	-	15	-	15	-	ns	14
32	tWCR	Write Command Hold Time from RAS	50	-	55	-	60	-	ns	
33	tWP	Write Command Pulse Width	10	-	10	-	10	-	ns	
34	tRWL	Write Command to RAS Lead Time	20	-	20	-	20	-	ns	
35	tCWL	Write Command to CAS Lead Time	20	-	20	-	20	-	ns	16
36	tDS	Data-In Set-up Time	0	-	0	-	0	-	ns	7
37	tDH	Data-In Hold Time	15	-	15	-	15	-	ns	7
38	tDHR	Data-In Hold Time Referenced to RAS	50	-	55	-	60	-	ns	
39	tREF	Refresh Period (512 cycles)	-	8	-	8	-	8	ms	
		SL-part	-	128	-	128	-	128		11
40	tWCS	Write Command Set-up Time	0	-	0	-	0	-	ns	8,14

**AC CHARACTERISTICS**

(continued)

#	SYMBOL	PARAMETER	HY514260JC/TC/RC/SLJC/SLTC/SLRC						UNIT	NOTE
			-60		-70		-80			
			MIN.	MAX.	MIN.	MAX.	MIN.	MAX.		
41	tCWD	CAS to WE Delay Time	45	-	45	-	45	-	ns	8
42	trWD	RAS to WE Delay Time	85	-	95	-	105	-	ns	8
43	tAWD	Column Address to WE Delay Time	55	-	60	-	65	-	ns	8
44	tCSR	CAS Set-up Time (CBR Cycle)	10	-	10	-	10	-	ns	14
45	tCHR	CAS Hold Time (CBR Cycle)	15	-	15	-	15	-	ns	15
46	trPC	RAS to CAS Precharge Time	10	-	10	-	10	-	ns	14
47	tcPT	CAS Precharge Time (CBR Counter Test)	20	-	20	-	20	-	ns	17
48	trOH	RAS Hold Time Referenced to OE	10	-	10	-	10	-	ns	
49	toEA	OE Access Time	0	20	0	20	0	20	ns	
50	toED	OE to Data Delay	20	-	20	-	20	-	ns	
51	toEZ	Output Buffer Turn Off Delay Time from OE	0	15	0	15	0	15	ns	5
52	toEH	OE Command Hold Time	20	-	20	-	20	-	ns	
53	tcPWD	WE Delay Time from CAS Precharge	60	-	65	-	70	-	ns	8
54	trHCP	RAS Hold Time from CAS Precharge	30	-	35	-	35	-	ns	
55	trASS	RAS Pulse Width (Self Refresh)	100	-	100	-	100	-	μs	
56	trPS	RAS Precharge Time (Self Refresh)	120	-	130	-	150	-	ns	
57	tCHS	CAS Hold Time from RAS (Self Refresh)	-50	-	-50	-	-50	-	ns	

**NOTE :**

1. An initial pause of 200 $\mu$ s is required after power-up followed by 8 RAS cycles before proper device operation is achieved. In case of using internal refresh counter, a minimum of 8 CAS-before-RAS initialization cycles instead of 8 RAS-only refresh cycles are required. The device should be carefully initialized to be prevented from being entered into multi bit test mode during initialization.
2. AC measurements assume  $t_T = 5ns$ .
3.  $V_{IH}(min.)$  and  $V_{IL}(max.)$  are reference levels for measuring timing of input signals. Also, transition times are measured between  $V_{IH}$  and  $V_{IL}$ .
4. Measured at  $V_{OH} = 2.4V$  and  $V_{OL} = 0.4V$  with a load equivalent to 2 TTL loads and 100pF.
5.  $t_{OFF}(max.)$  and  $t_{OEZ}$  define the time at which the output achieves the open circuit condition and is not referenced to output voltage levels.
6. Either  $t_{RCH}$  or  $t_{RRH}$  must be satisfied for a read cycle.
7. These parameters are referenced to LCAS or UCAS leading edge in early write cycles and to WE leading edge in Read-Modify-Write cycles.
8.  $t_{WCS}$ ,  $t_{RWD}$ ,  $t_{CWD}$ ,  $t_{AWD}$  and  $t_{CPWD}$  are not restrictive operating parameters. They are included in the data sheet as electrical characteristics only. If  $t_{WCS} \geq t_{WCS}(min.)$ , the cycle is an early write cycle and data out pin will remain open circuit (high impedance) through the entire cycle. If  $t_{RWD} \geq t_{RWD}(min.)$ ,  $t_{CWD} \geq t_{CWD}(min.)$ ,  $t_{AWD} \geq t_{AWD}(min.)$ , and  $t_{CPWD} \geq t_{CPWD}(min.)$ , the cycle is a Read-Modify-Write cycle and data out will contain data read from the selected cell. If neither of the above sets of conditions is satisfied, the condition of the data out (at access time) is indeterminated.
9. Operation within the  $t_{RCD}(max.)$  limit insures that  $t_{RAC}(max.)$  can be met.  $t_{RCD}(max.)$  is specified as a reference point only. If  $t_{RCD}$  is greater than the specified  $t_{RCD}(max.)$  limit, then access time is controlled by  $t_{CAC}$ .
10. Operation within the  $t_{RAD}(max.)$  limit insures that  $t_{RAC}(max.)$  can be met.  $t_{RAD}(max.)$  is specified as a reference point only. If  $t_{RAD}$  is greater than the specified  $t_{RAD}(max.)$  limit, then access time is controlled by  $t_{AA}$ .
11.  $t_{REF}(max.) = 128ms$  is applied to SL-parts only (HY514260SLJC, HY514260SLTC and HY514260SLRC).
12. A burst of 512 CAS-before-RAS refresh cycles must be executed within 8ms (128ms for SL-part) after exiting Self refresh.
13. When both LCAS and UCAS go low at the same time, all 16-bits data are written into the device. LCAS and UCAS must be transitioned simultaneously within a same read or write cycle.
14. These parameters are determined by the earlier falling edge of LCAS or UCAS.
15. These parameters are determined by the later rising edge of LCAS or UCAS.
16.  $t_{CWL}$  must be satisfied by both LCAS and UCAS for 16-bits access cycles.
17.  $t_{CP}$  and  $t_{CPT}$  are measured when both LCAS and UCAS are high state.

**CAPACITANCE**

( $T_A = 25^\circ C$ ,  $V_{CC} = 5V \pm 10\%$ ,  $V_{SS} = 0V$ ,  $f = 1MHz$ , unless otherwise noted.)

SYMBOL	PARAMETER	TYP.	MAX.	UNIT
CIN1	Input Capacitance (A0-A8)	-	5	pF
CIN2	Input Capacitance (RAS, CAS, WE, OE)	-	7	pF
CDO	Data Input/Output Capacitance (DQ0-DQ15)	-	7	pF

TIMING DIAGRAM

READ CYCLE

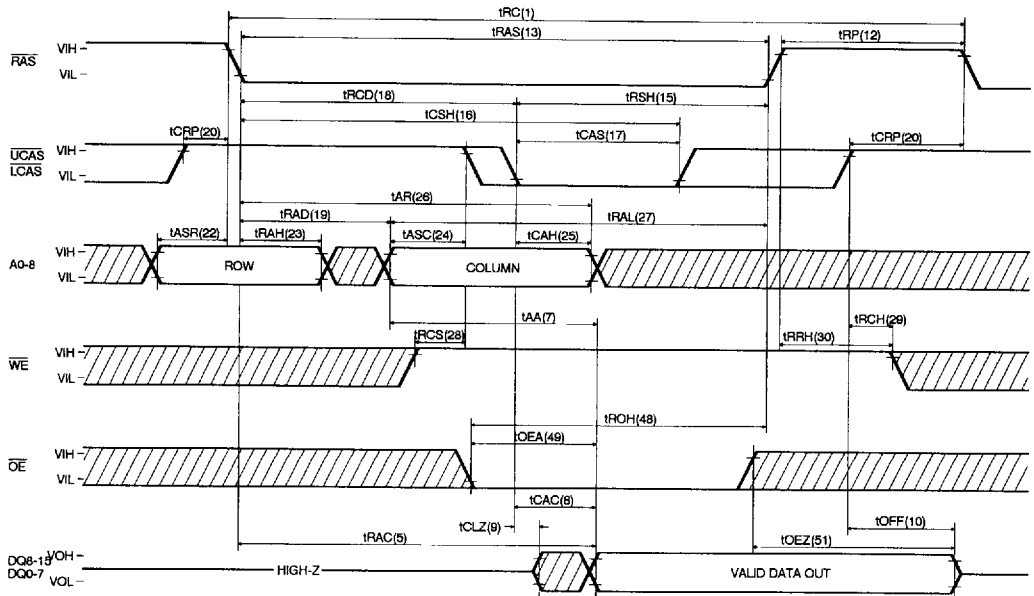

EARLY WRITE CYCLE

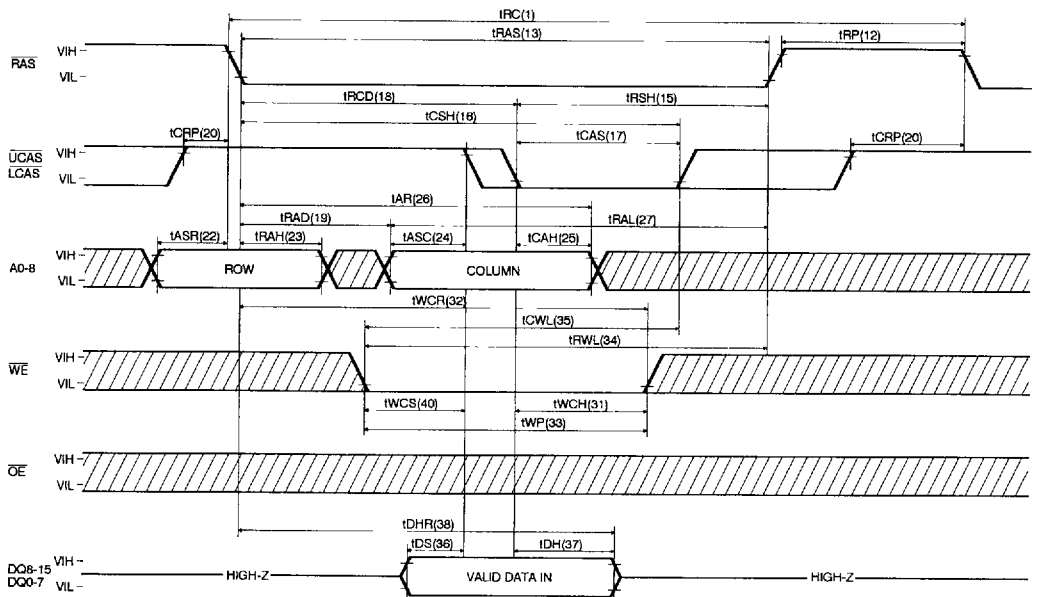

WRITE CYCLE ( $\overline{OE}$  CONTROLLED WRITE)

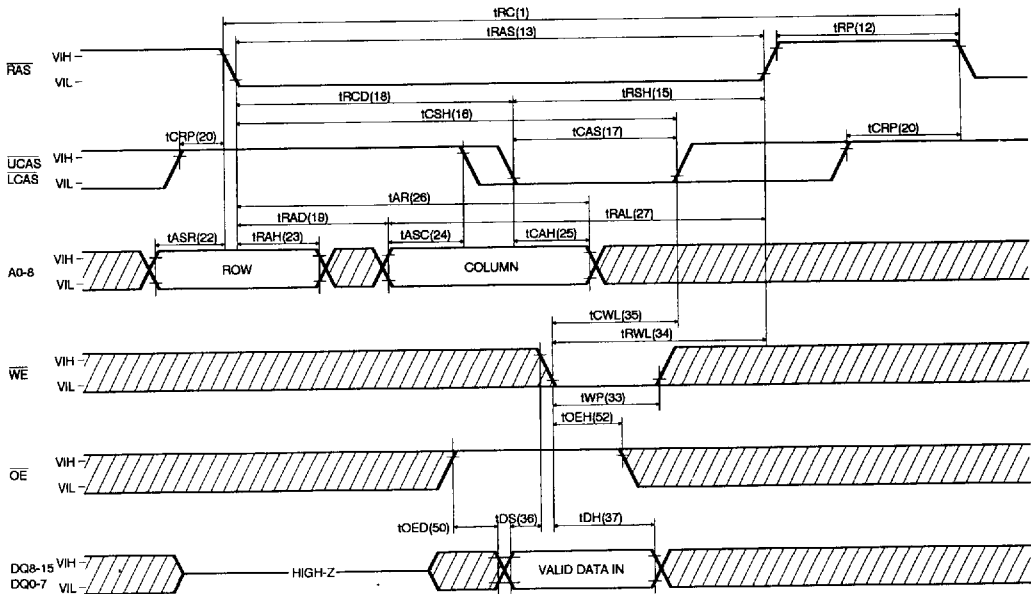

READ-MODIFY-WRITE CYCLE

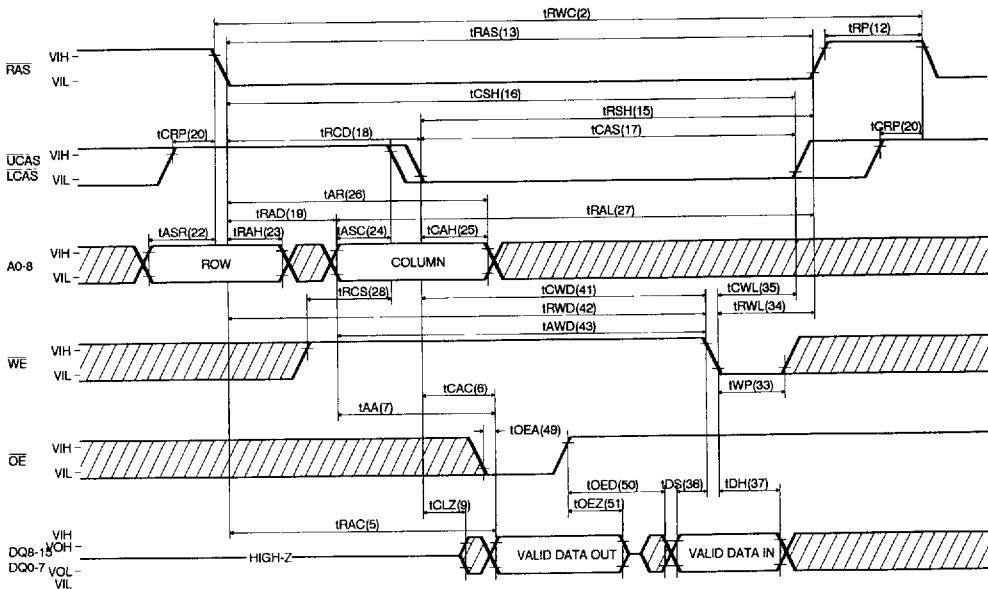



FAST PAGE MODE READ CYCLE

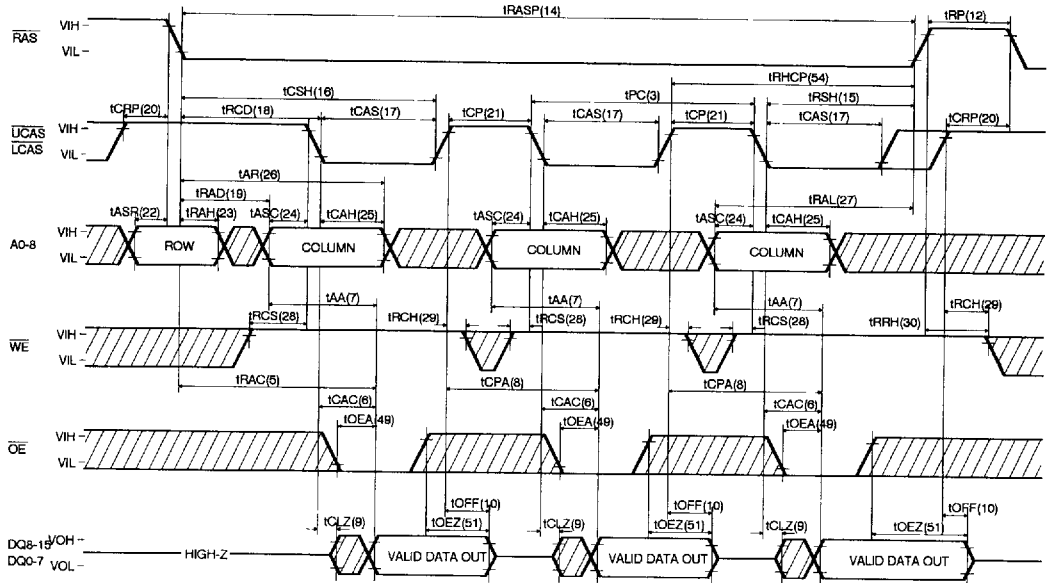

FAST PAGE MODE EARLY WRITE CYCLE

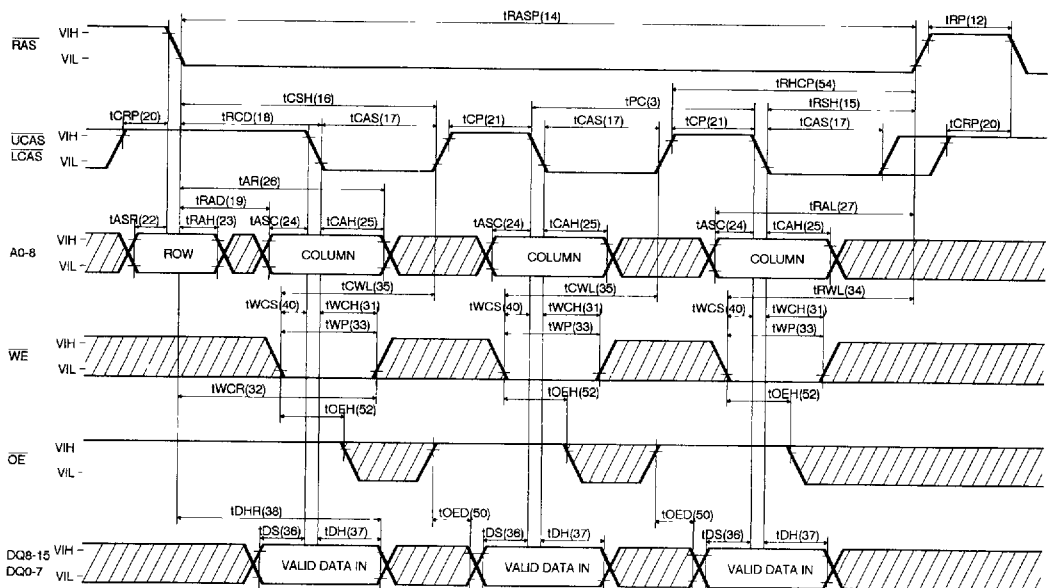

FAST PAGE MODE READ-MODIFY-WRITE CYCLE

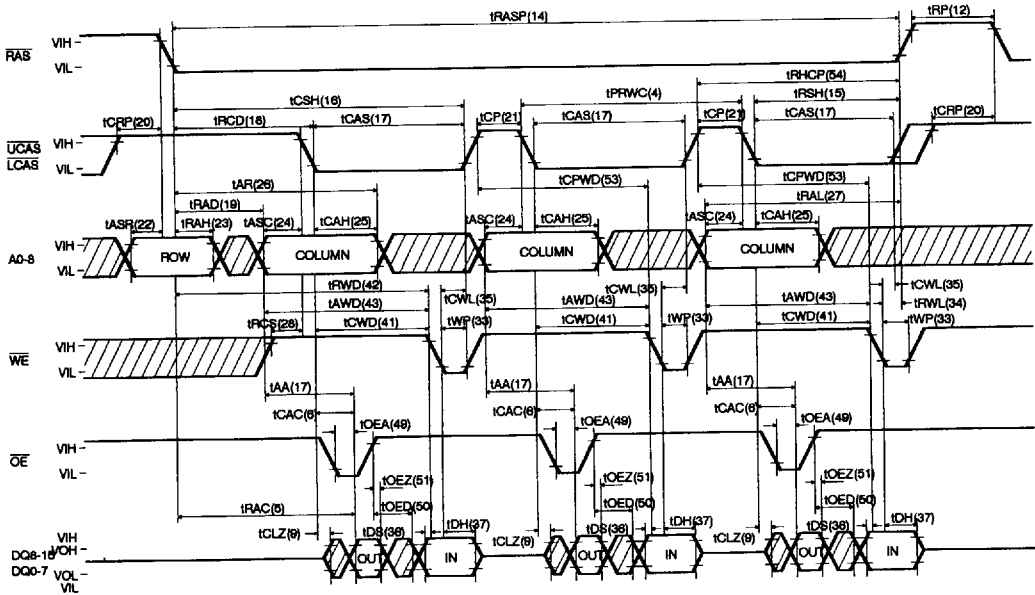

RAS-ONLY REFRESH CYCLE

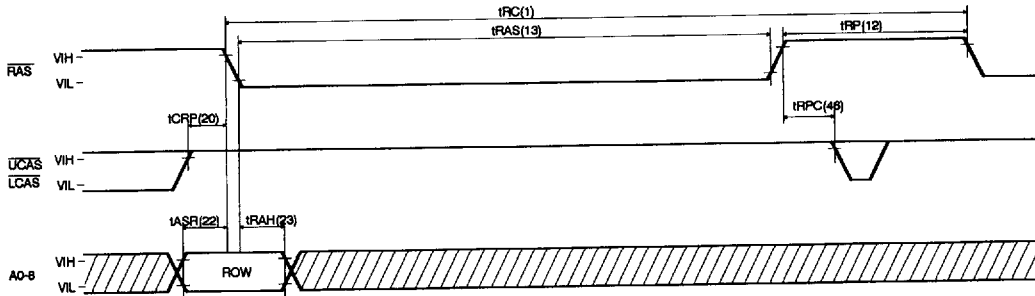

NOTE : OE and WE = "H" or "L"

CAS-BEFORE-RAS REFRESH CYCLE

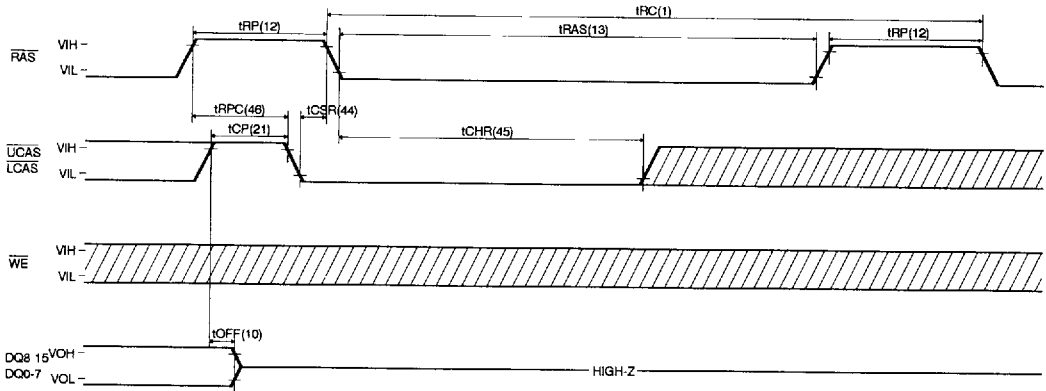

NOTE : A0-8 and OE = "H" or "L"

HIDDEN REFRESH CYCLE (READ)

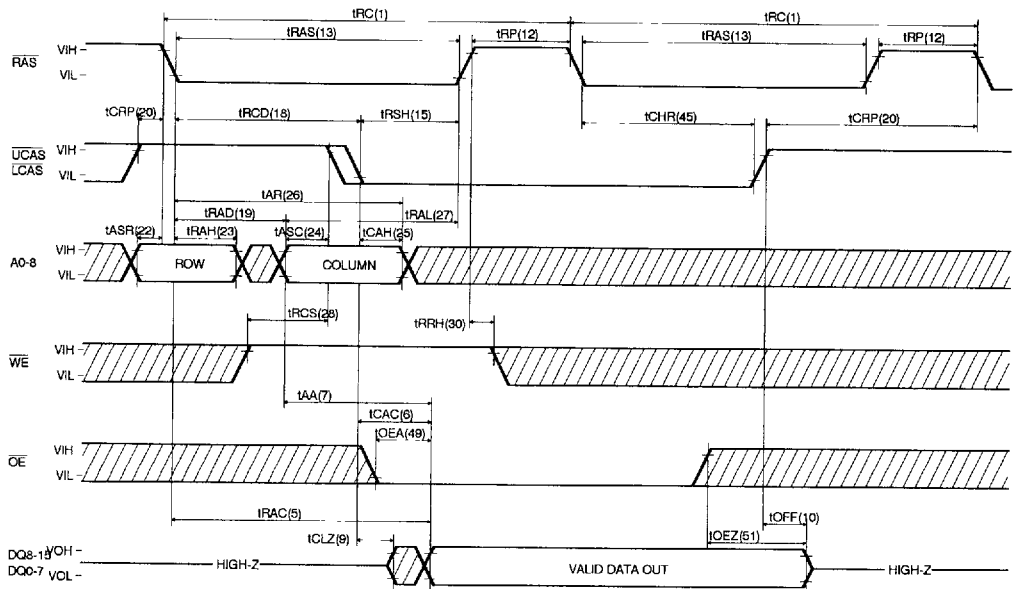

**HIDDEN REFRESH CYCLE (WRITE)**

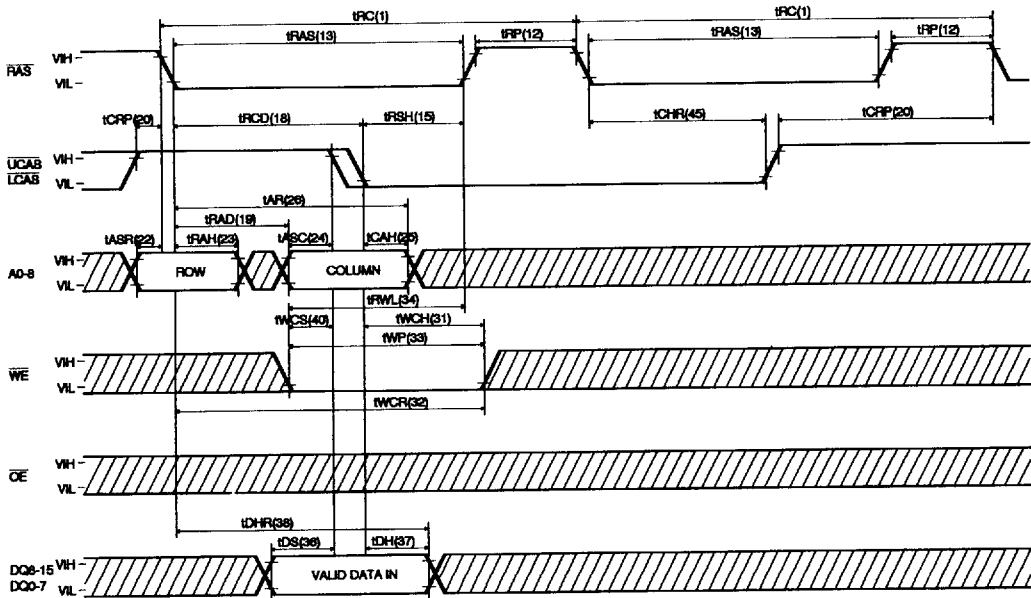

**CAS-BEFORE-RAS SELF REFRESH CYCLE**

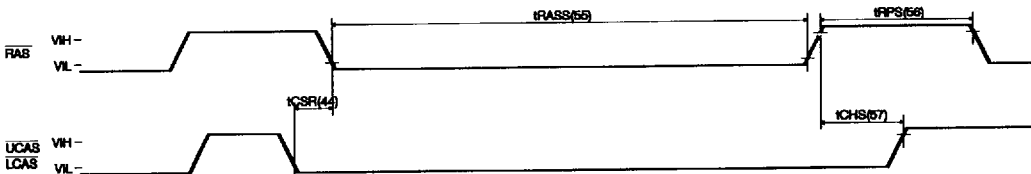

NOTE : A0-8, WE and OE = 'H' or 'L'

CAS-BEFORE-RAS REFRESH COUNTER TEST CYCLE

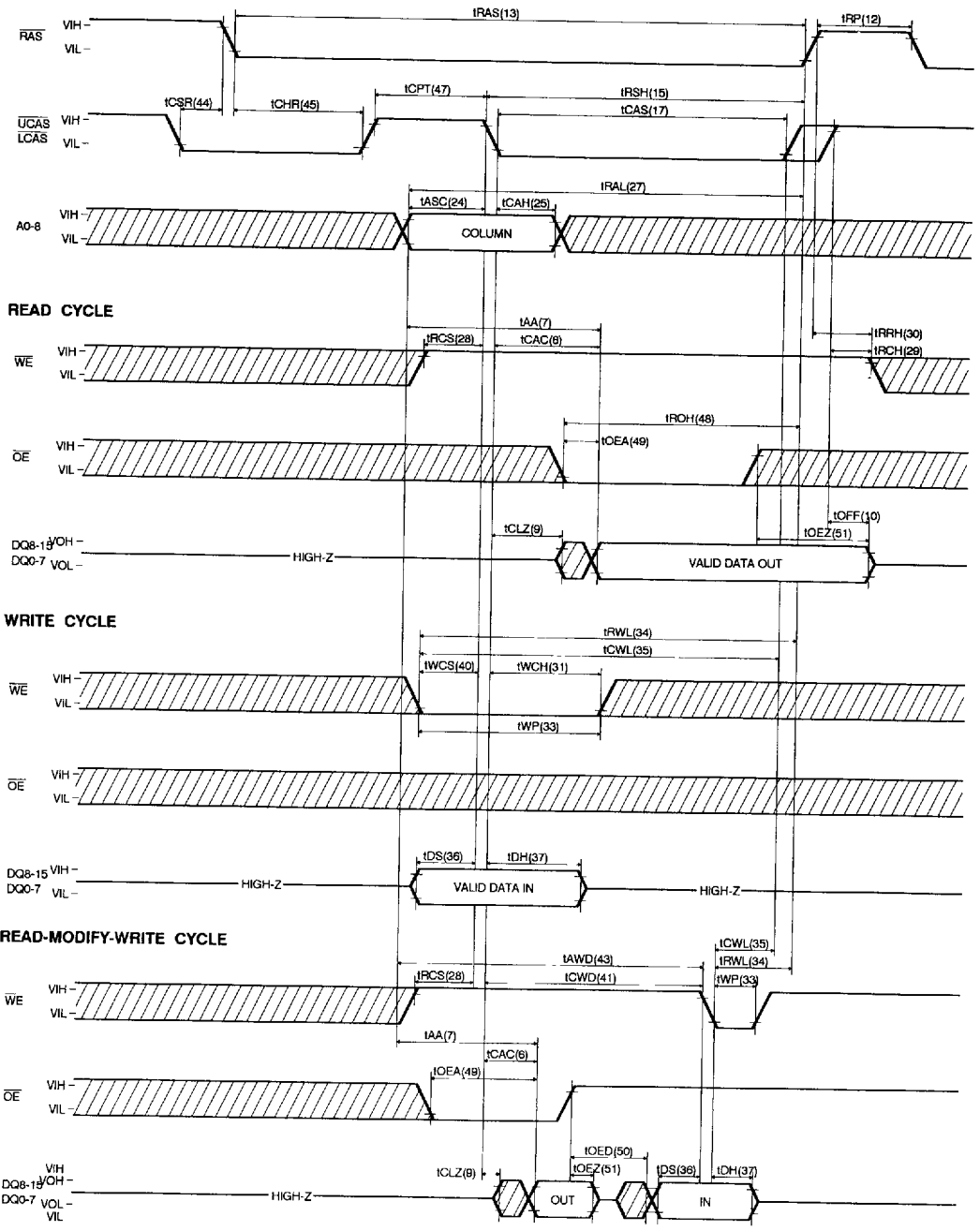

PACKAGE INFORMATION

400 mil 40 pin Small Outline J-form Package (JC)

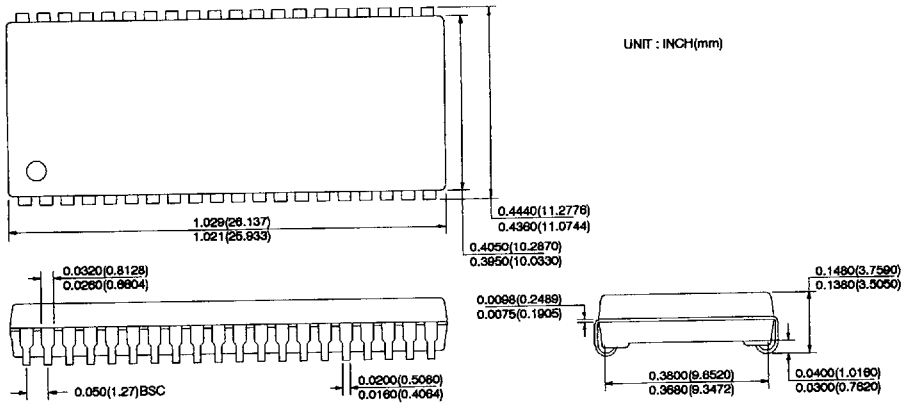

400 mil 40/44 pin Thin Small Outline Package (TC) (RC)

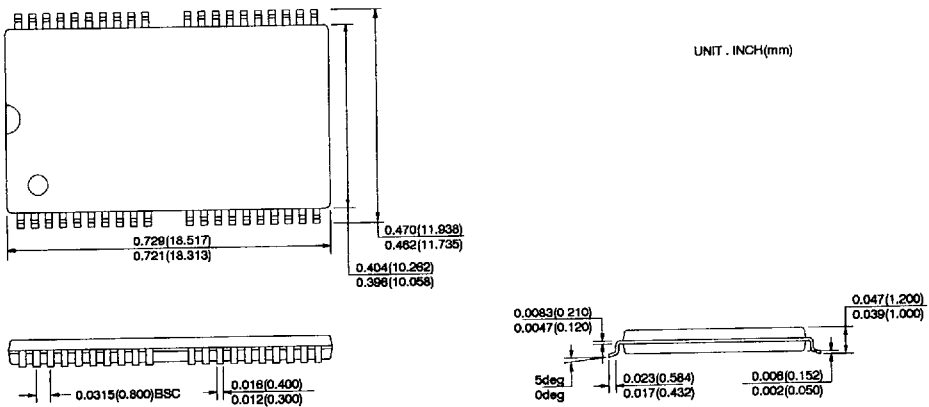

**ORDERING INFORMATION**

PART NUMBER	SPEED	POWER	PACKAGE
HY514260JC	60/70/80		SOJ
HY514260SLJC	60/70/80	SL-part	SOJ
HY514260TC	60/70/80		TSOP-II
HY514260SLTC	60/70/80	SL-part	TSOP-II
HY514260RC	60/70/80		TSOP-II(R)
HY514260SLRC	60/70/80	SL-part	TSOP-II(R)