

### DESCRIPTION

The HY53C464 is fast dynamic RAM organized 65,536 x 4-bit. The HY53C464 utilizes Hyundai's CMOS silicon gate process technology as well as advanced circuit techniques to provide wide operating margins to the users. Multiplexed address inputs permit the HY53C464 to be packaged in a standard 300 mil 18 pin PDIP, 330mil 18pin PLCC.

The package size provides high system bit densities and is compatible with widely available automated testing and insertion equipments. System oriented feature includes single power supply of 5V± 10% tolerance and direct interfacing capability with high performance logic families such as Schottky TTL.

### FEATURES

- **Low power dissipation**  
 Max. CMOS standby 5.5 mW (L-part) 11.0mW  
 Max. TTL standby 11.0mW (L-part) 16.5mW

#### Max. operating

Speed	Power
70	385mW
80	330mW
10	275mW

- Single power supply of 5V± 10%
- TTL compatible inputs and outputs
- Fast access time

Speed	tRAC	tCAC	TPC
70	70ns	15ns	50ns
80	80ns	20ns	55ns
10	100ns	25ns	60ns

- Fast page mode operation
- Read-Modify-Write capability
- CAS-before-RAS, RAS-only, Hidden refresh
- 256 refresh cycles / 4ms

### PIN DESCRIPTION

RAS	Row Address Strobe
CAS	Column Address Strobe
WE	Write Enable
OE	Output Enable
A0-A7	Address Input
DQ0-DQ3	Data Input/Output
Vcc	Power (+ 5V)
Vss	Ground

### PIN CONNECTION

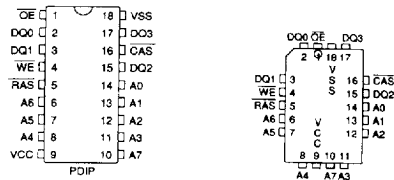

### BLOCK DIAGRAM

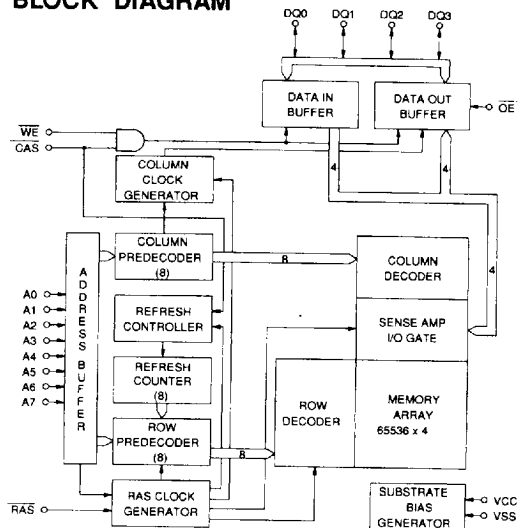

This document is a general product description and is subject to change without notice. Hyundai electronics does not assume any responsibility for use of circuits described. No patent licences are implied.  
 1AA02-20-MAY94

**ABSOLUTE MAXIMUM RATINGS**

SYMBOL	PARAMETER	RATING	UNIT
TA	Ambient Temperature	0 to 70	°C
TSTG	Storage Temperature	-55 to 125	°C
VIN, VOUT	Voltage on Any Pin Relative to Vss	-1.0 to 7.0	V
Vcc	Voltage on Vcc Relative to Vss	-1.0 to 7.0	V
I <sub>OS</sub>	Short Circuit Output Current	50	mA
Pd	Power Dissipation	1.0	W
TSOLDER	Soldering Temperature* Time	260* 10	°C* sec

NOTE : Operation at or above Absolute Maximum Ratings can adversely affect device reliability.

**RECOMMENDED DC OPERATING CONDITIONS**

(TA= 0°C to 70°C)

SYMBOL	PARAMETER	MIN.	TYP.	MAX.	UNIT
Vcc	Supply Voltage	4.5	5.0	5.5	V
VIH	Input High Voltage	2.4	-	Vcc+ 1.0	V
VIL	Input Low Voltage	-1.0	-	0.8	V

NOTE : All voltages are referenced to Vss.

**DC CHARACTERISTICS**

(TA= 0°C to 70°C, Vcc= 5V± 10%, Vss= 0V, unless otherwise noted.)

SYMBOL	PARAMETER	TEST CONDITIONS	SPEED/ POWER	MIN.	MAX.	UNIT	NOTE
I <sub>LI</sub>	Input Leakage Current (Any Input Pins)	V <sub>SS</sub> ≤ V <sub>IN</sub> ≤ V <sub>CC</sub> , All other pins not under test= V <sub>SS</sub>		-10	10	μA	
I <sub>LO</sub>	Output Leakage Current (High Impedance State)	V <sub>SS</sub> ≤ V <sub>OUT</sub> ≤ V <sub>CC</sub> , RAS & CAS at V <sub>IH</sub>		-10	10	μA	
I <sub>CC1</sub>	V <sub>CC</sub> Supply Current, Operating	t <sub>RC</sub> = t <sub>RC</sub> (min.)	70 80 100	-	70 60 50	mA	1,2,3
I <sub>CC2</sub>	V <sub>CC</sub> Supply Current, TTL Standby	RAS & CAS at V <sub>IH</sub> , other inputs ≥ V <sub>SS</sub>	L-part	-	3 2	mA	4
I <sub>CC3</sub>	V <sub>CC</sub> Supply Current, RAS-only refresh	t <sub>RC</sub> = t <sub>RC</sub> (min.)	70 80 100	-	70 60 50	mA	1,3
I <sub>CC4</sub>	V <sub>CC</sub> Supply Current, Fast Page mode	t <sub>PC</sub> = t <sub>PC</sub> (min.)	70 80 100	-	45 40 35	mA	1,2,3
I <sub>CC5</sub>	V <sub>CC</sub> Supply Current, CMOS Standby	RAS & CAS ≤ V <sub>CC</sub> -0.2V	L-part	-	2 1	mA	4
I <sub>CC6</sub>	V <sub>CC</sub> Supply Current, CAS-before-RAS refresh	t <sub>RC</sub> = t <sub>RC</sub> (min.)	70 80 100	-	70 60 50	mA	1,3
V <sub>OL</sub>	Output Low Voltage	I <sub>OL</sub> = 4.2mA		-	0.4	V	
V <sub>OH</sub>	Output High Voltage	I <sub>OH</sub> = -5mA		2.4	-	V	

**NOTE :**

1. I<sub>CC1</sub>, I<sub>CC3</sub>, I<sub>CC4</sub> and I<sub>CC6</sub> depend on cycle rate.
2. I<sub>CC1</sub> and I<sub>CC4</sub> depend on output loading. Specified values are obtained with the output open.
3. It depends on user whether column address is changed or not at least once while RAS= V<sub>IL</sub> and CAS= V<sub>IH</sub>.
4. I<sub>CC2</sub>(max.)= 2mA and I<sub>CC5</sub>(max.)= 1mA are applied to L-part only (HY53C464LS and HY53C464LF).

**AC CHARACTERISTICS**

(TA= 0°C to 70°C, VCC= 5V± 10%, VSS= 0V, unless otherwise noted.) NOTE : 1, 2, 3

#	SYMBOL	PARAMETER	HY53C464S/F/LS/LF						UNIT	NOTE
			-70		-80		-10			
			MIN.	MAX.	MIN.	MAX.	MIN.	MAX.		
1	tRC	Random Read or Write Cycle Time	130	-	145	-	175	-	ns	
2	tRWC	Read-Modify-Write Cycle Time	195	-	225	-	265	-	ns	
3	tPC	Fast Page Mode Cycle Time	50	-	55	-	65	-	ns	
4	tPRWC	Fast Page Mode Read-Modify-Write Cycle Time	105	-	120	-	140	-	ns	
5	tRAC	Access Time from RAS	-	70	-	80	-	100	ns	4,9,10
6	tCAC	Access Time from CAS	-	25	-	30	-	35	ns	4,9
7	tAA	Access Time from Column Address	-	35	-	40	-	45	ns	4,10
8	tCPA	Access Time from CAS Precharge	-	45	-	50	-	55	ns	4
9	tCLZ	CAS to Output Low Impedance	0	-	0	-	0	-	ns	4
10	tOFF	Output Buffer Turn-off Delay	0	15	0	20	0	25	ns	5
11	tT	Transition Time (Rise and Fall)	3	25	3	25	3	25	ns	3
12	tRP	RAS Precharge Time	50	-	55	-	65	-	ns	
13	tRAS	RAS Pulse Width	70	75K	80	75K	100	75K	ns	
14	tRASP	RAS Pulse Width (Fast Page Mode)	70	75K	80	75K	100	75K	ns	
15	tRSH	RAS Hold Time	25	-	30	-	35	-	ns	
16	tCSH	CAS Hold Time	70	-	80	-	100	-	ns	
17	tCAS	CAS Pulse Width	25	-	30	-	35	-	ns	
18	tRCD	RAS to CAS Delay	25	45	25	50	25	65	ns	9
19	tRAD	RAS to Column Address Delay Time	20	35	20	40	20	55	ns	10
20	tCRP	CAS to RAS Precharge Time	15	-	15	-	15	-	ns	
21	tCP	CAS Precharge Time	15	-	15	-	20	-	ns	
22	tASR	Row Address Set-up Time	0	-	0	-	0	-	ns	
23	tRAH	Row Address Hold Time	15	-	15	-	15	-	ns	
24	tASC	Column Address Set-up Time	0	-	0	-	0	-	ns	
25	tCAH	Column Address Hold Time	15	-	15	-	20	-	ns	
26	tAR	Column Address Hold Time from RAS	55	-	60	-	70	-	ns	
27	tRAL	Column Address to RAS Lead Time	35	-	40	-	45	-	ns	
28	tRCS	Read Command Set-up Time	0	-	0	-	0	-	ns	
29	tRCH	Read Command Hold Time Referenced to CAS	5	-	5	-	5	-	ns	6
30	tRRH	Read Command Hold Time Referenced to RAS	5	-	5	-	5	-	ns	6
31	tWCH	Write Command Hold Time	15	-	15	-	20	-	ns	
32	tWCR	Write Command Hold Time from RAS	55	-	60	-	70	-	ns	
33	tWP	Write Command Pulse Width	15	-	15	-	20	-	ns	
34	tRWL	Write Command to RAS Lead Time	25	-	30	-	35	-	ns	
35	tCWL	Write Command to CAS Lead Time	25	-	30	-	35	-	ns	
36	tDS	Data-In Set-up Time	0	-	0	-	0	-	ns	7
37	tDH	Data-In Hold Time	15	-	15	-	20	-	ns	7
38	tDHR	Data-In Hold Time Referenced to RAS	55	-	60	-	70	-	ns	
39	tREF	Refresh Period (256 cycles)	-	4	-	4	-	4	ms	
40	tWCS	Write Command Set-up Time	0	-	0	-	0	-	ns	8

**AC CHARACTERISTICS**

(continued)

#	SYMBOL	PARAMETER	HY53C464S/F/LS/LF						UNIT	NOTE
			-70		-80		-10			
			MIN.	MAX.	MIN.	MAX.	MIN.	MAX.		
41	tcWD	CAS to WE Delay Time	50	-	60	-	70	-	ns	8
42	trWD	RAS to WE Delay Time	95	-	110	-	135	-	ns	8
43	tAWD	Column Address to WE Delay Time	60	-	70	-	80	-	ns	8
44	tCSR	CAS Set-up Time (CBR Cycle)	10	-	10	-	10	-	ns	
45	tCHR	CAS Hold Time (CBR Cycle)	20	-	25	-	30	-	ns	
46	trPC	RAS to CAS Precharge Time	0	-	0	-	0	-	ns	
47	tcPT	CAS Precharge Time (CBR Counter Test)	15	-	15	-	20	-	ns	
48	tROH	RAS Hold Time Reference to OE	0	-	0	-	0	-	ns	
49	toEA	OE Access Time	-	15	-	20	-	25	ns	
50	toED	OE to Data Delay	20	-	25	-	30	-	ns	
51	toEZ	Output Buffer Turn Off Delay Time from OE	0	15	0	20	0	25	ns	5
52	toEH	OE Command Hold Time	20	-	20	-	25	-	ns	
53	trRW	RAS Pulse Width (RMW)	125	-	145	-	175	-	ns	
54	trCW	CAS Pulse Width (RMW)	80	-	95	-	110	-	ns	

**NOTE :**

1. An initial pause of 200 $\mu$ s is required after power-up followed by 8  $\overline{\text{RAS}}$  cycles before proper device operation is achieved. In case of using internal refresh counter, a minimum of 8  $\overline{\text{CAS}}$ -before- $\overline{\text{RAS}}$  initialization cycles instead of 8  $\overline{\text{RAS}}$  cycles are required.
2. AC measurements assume  $t_r = 5\text{ns}$ .
3.  $V_{IH}(\text{min.})$  and  $V_{IL}(\text{max.})$  are reference levels for measuring timing of input signals. Also, transition times are measured between  $V_{IH}$  and  $V_{IL}$ .
4. Measured with a load equivalent to 2 TTL loads and 100pF.
5.  $t_{OFF}(\text{max.})$  and  $t_{OEZ}$  and define the time at which the output achieves the open circuit condition and is not referenced to output voltage levels.
6. Either  $t_{RCH}$  or  $t_{RRH}$  must be satisfied for a read cycle.
7. These parameters are referenced to  $\overline{\text{CAS}}$  leading edge in early write cycles and to  $\overline{\text{WE}}$  leading edge in Read-Modify-Write cycles.
8.  $t_{WCS}$ ,  $t_{RWD}$ ,  $t_{CWD}$  and  $t_{AWD}$  are not restrictive operating parameters. They are included in the data sheet as electrical characteristics only. If  $t_{WCS} \geq t_{WCS}(\text{min.})$ , the cycle is an early write cycle and data out pin will remain open circuit (high impedance) through the entire cycle. If  $t_{RWD} \geq t_{RWD}(\text{min.})$ ,  $t_{CWD} \geq t_{CWD}(\text{min.})$  and  $t_{AWD} \geq t_{AWD}(\text{min.})$  the cycle is a Read-Modify-Write cycle and data out will contain data read from the selected cell. If neither of the above sets of conditions is satisfied, the condition of the data out (at access time) is indeterminated.
9. Operation within the  $t_{RCD}(\text{max.})$  limit insures that  $t_{RAC}(\text{max.})$  can be met.  $t_{RCD}(\text{max.})$  is specified as a reference point only. If  $t_{RCD}$  is greater than the specified  $t_{RCD}(\text{max.})$  limit, then access time is controlled by  $t_{CAC}$ .
10. Operation within the  $t_{RAD}(\text{max.})$  limit insures that  $t_{RAC}(\text{max.})$  can be met.  $t_{RAD}(\text{max.})$  is specified as a reference point only. If  $t_{RAD}$  is greater than the specified  $t_{RAD}(\text{max.})$  limit, then access time is controlled by  $t_{AA}$ .

**CAPACITANCE**

( $T_A = 25^\circ\text{C}$ ,  $V_{CC} = 5V \pm 10\%$ ,  $V_{SS} = 0V$ , unless otherwise noted.)

SYMBOL	PARAMETER	TYP.	MAX.	UNIT
CIN1	Input Capacitance (A0-A7, D)	-	6	pF
CIN2	Input Capacitance ( $\overline{\text{RAS}}$ , $\overline{\text{CAS}}$ , $\overline{\text{WE}}$ , $\overline{\text{OE}}$ )	-	8	pF
COU	Output Capacitance (Q)	-	8	pF

**TIMING DIAGRAM**

**READ CYCLE**

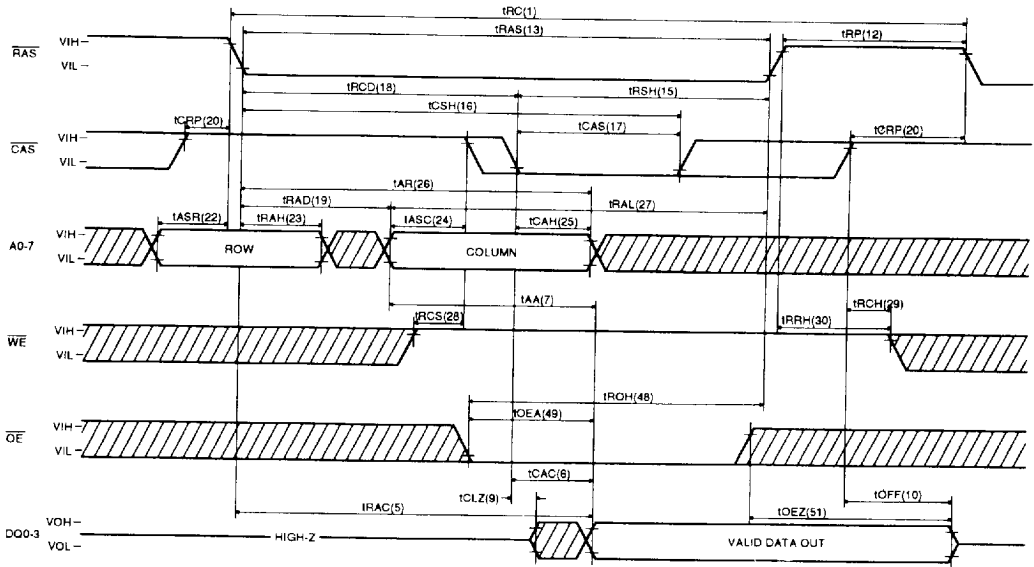

**EARLY WRITE CYCLE**

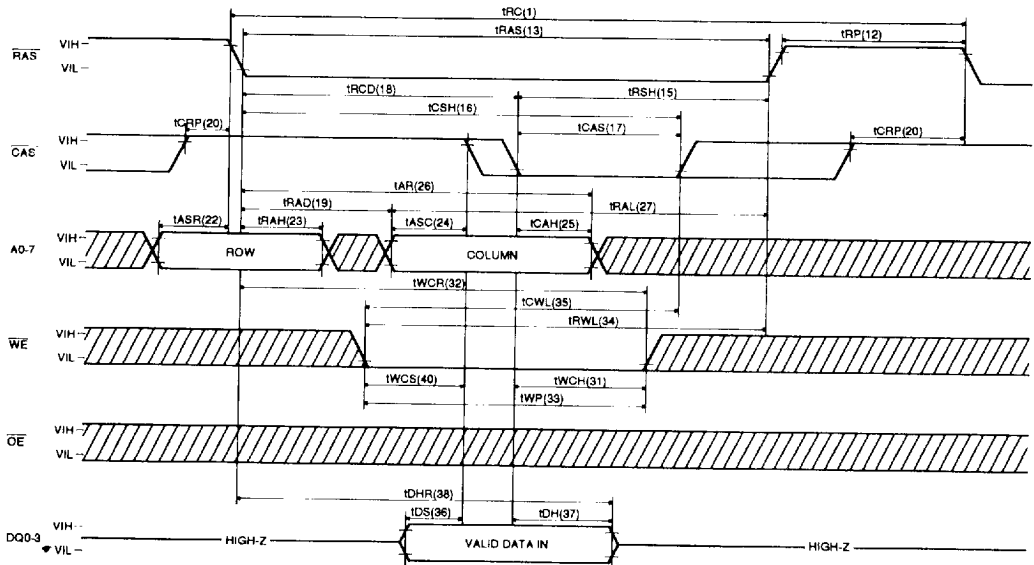

**WRITE CYCLE ( $\overline{OE}$  CONTROLLED WRITE)**

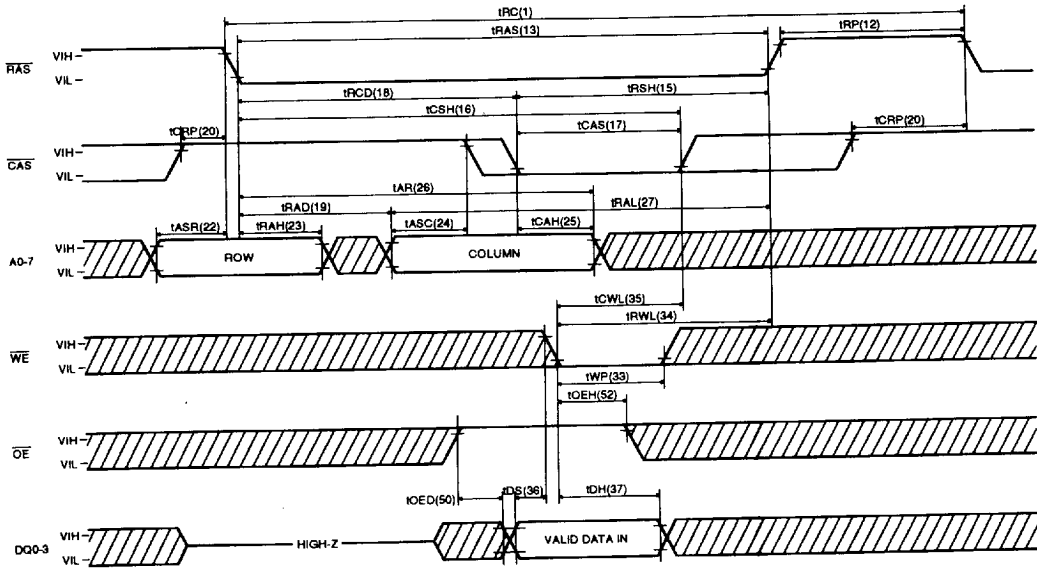

**READ-MODIFY-WRITE CYCLE**

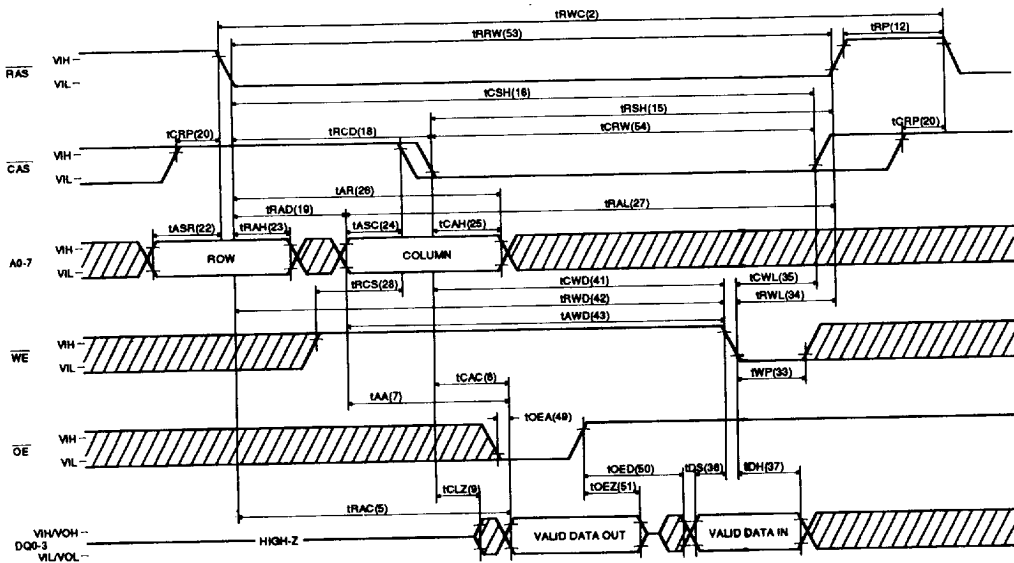

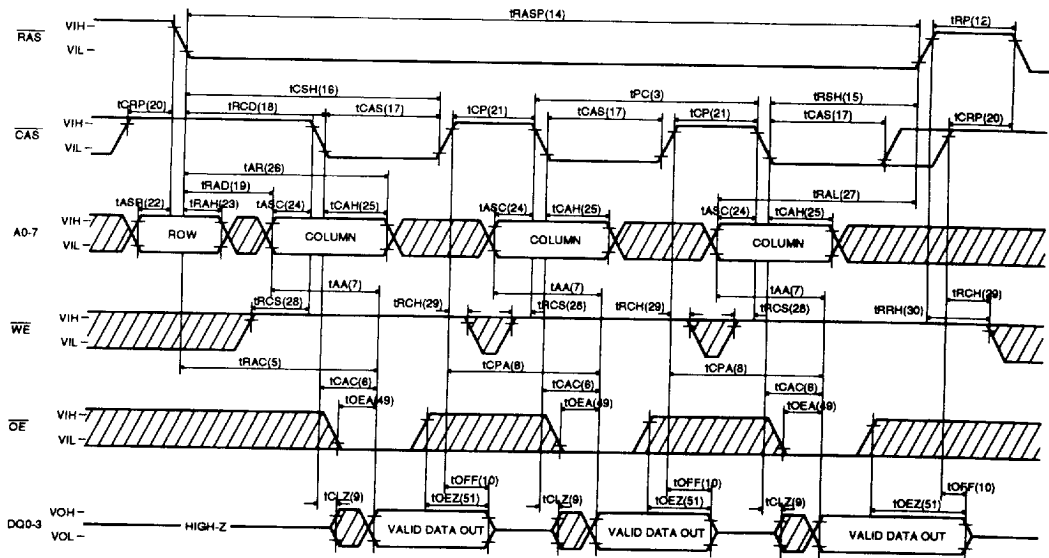
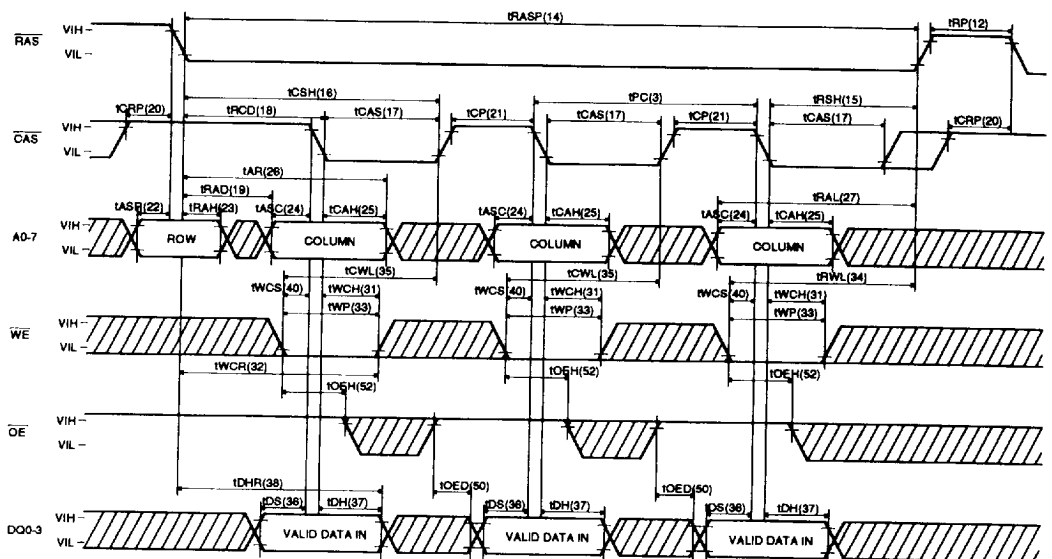

**FAST PAGE MODE READ CYCLE****FAST PAGE MODE EARLY WRITE CYCLE**

**FAST PAGE MODE READ-MODIFY-WRITE CYCLE**

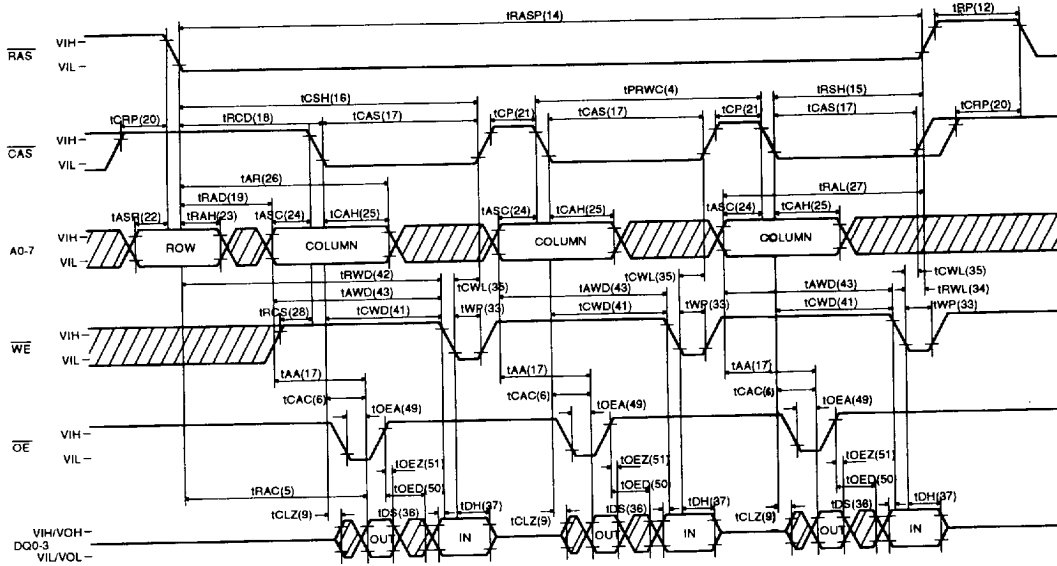

**RAS-ONLY REFRESH CYCLE**

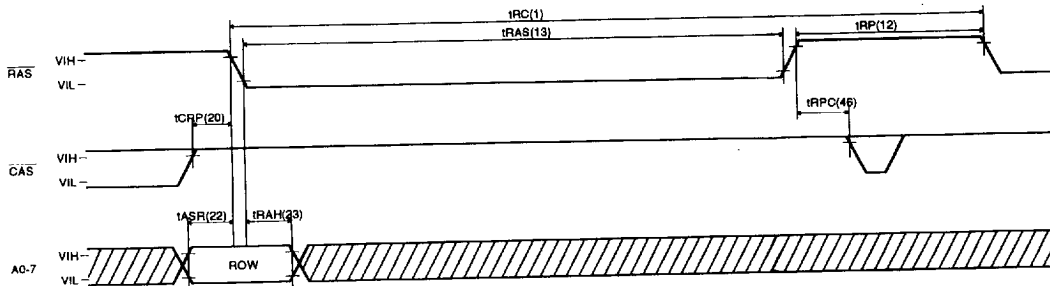

NOTE : OE and WE = "H" or "L"

**CAS-BEFORE-RAS REFRESH CYCLE**

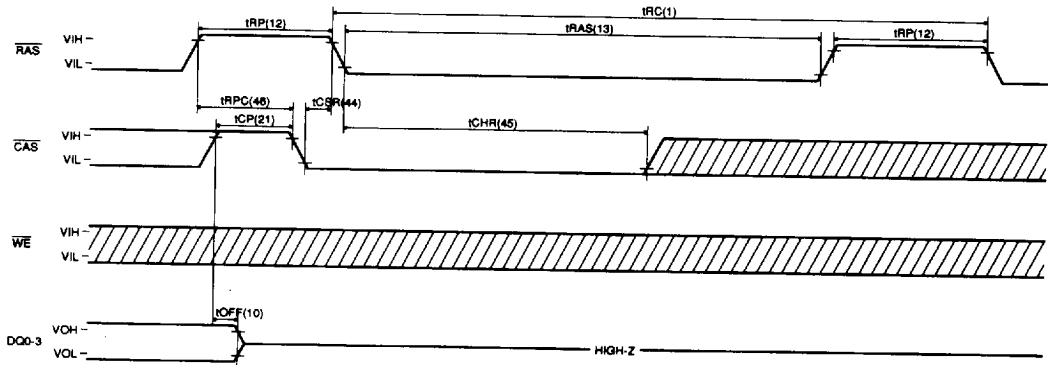

NOTE : A0-7 and OE = "H" or "L"

**HIDDEN REFRESH CYCLE (READ)**

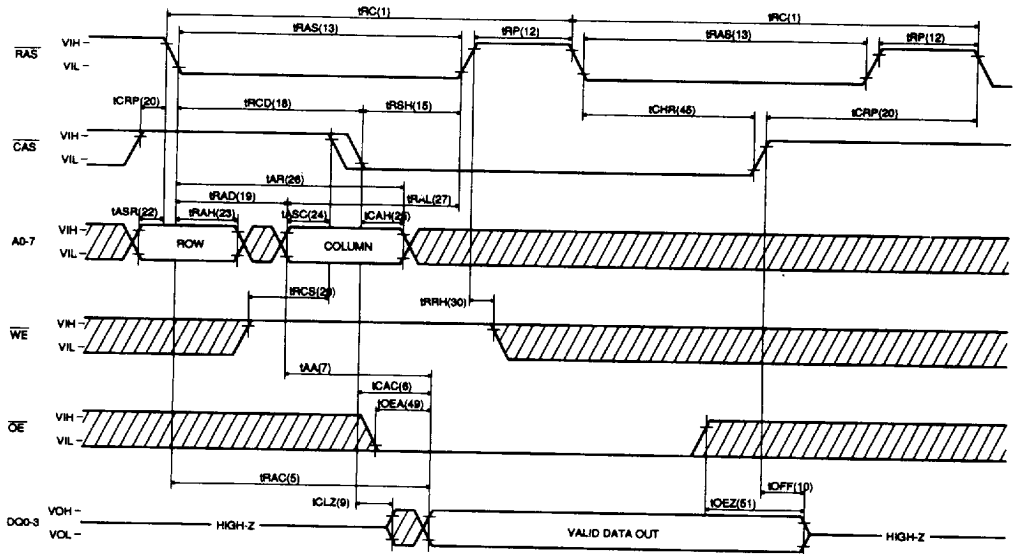

HIDDEN REFRESH CYCLE (WRITE)

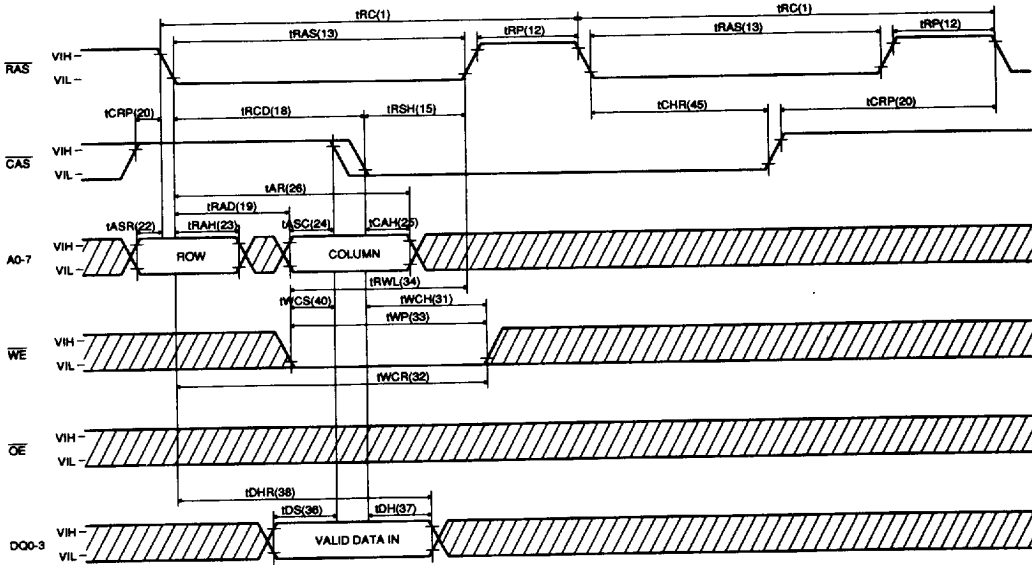

CAS-BEFORE-RAS REFRESH CYCLE TEST CYCLE

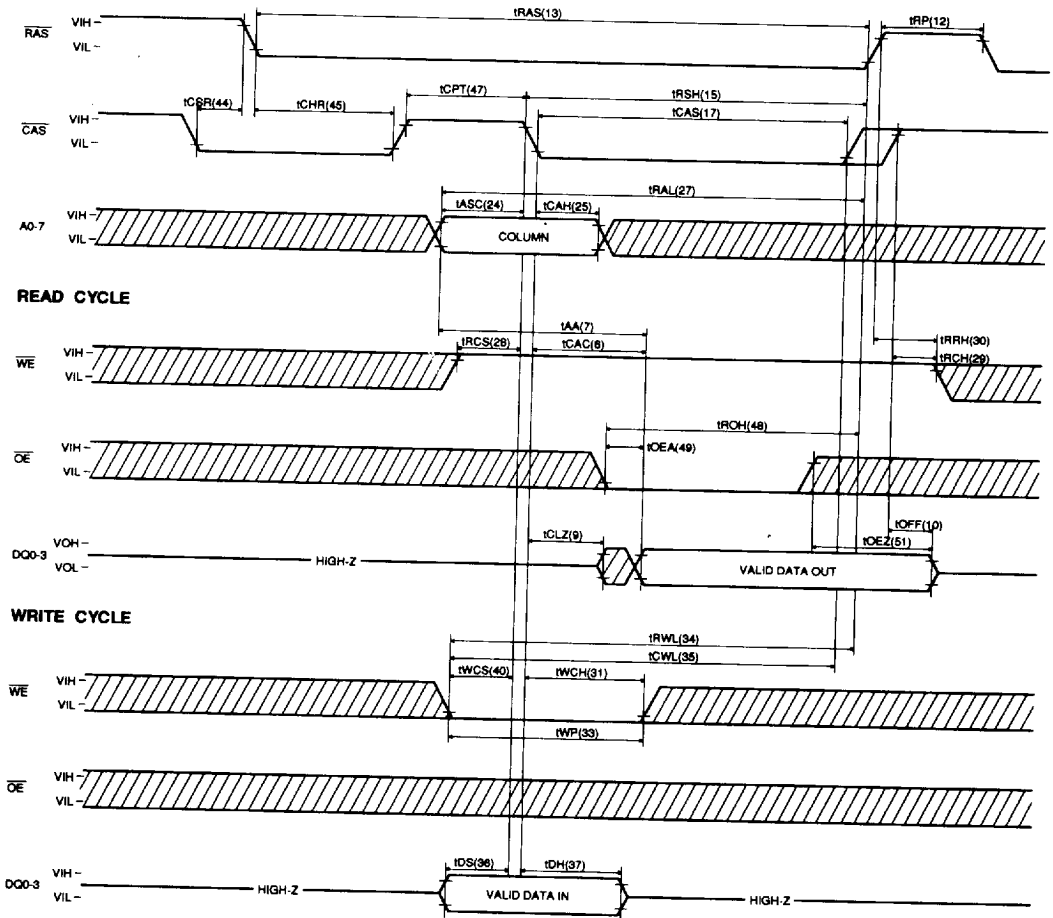

**PACKAGE INFORMATION**

**300 mil 18 Pin Dual In Line (S)**

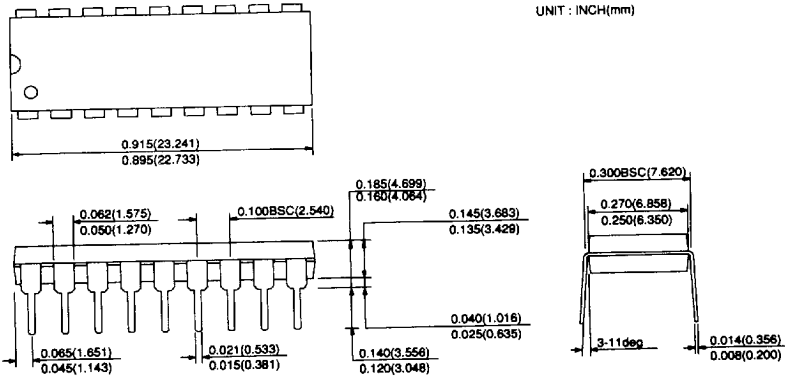

**330 mil 18 pin Plastic Leaded Chip Carrier (F)**

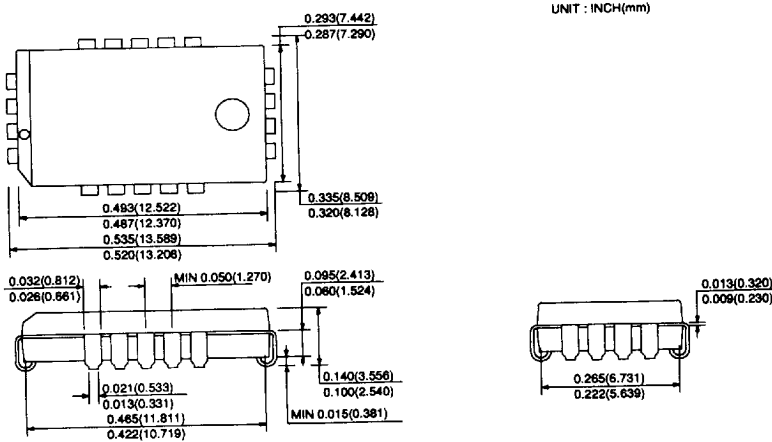

**ORDERING INFORMATION**

PART NUMBER	SPEED	POWER	PACKAGE
HY53C464S	70/80/10		PDIP
HY53C464LS	70/80/10	L-part	PDIP
HY53C464F	70/80/10		PLCC
HY53C464LF	70/80/10	L-part	PLCC