

90 Degree Hybrid 0.82–0.90 GHz



HY86-12

Features

- Low Cost
- Low Profile
- Small SOIC-8 Package
- Tape & Reel

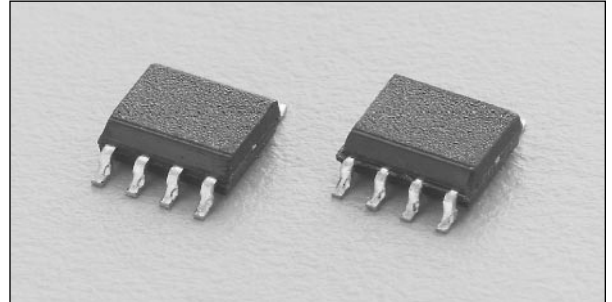

Description

The HY86-12 is a 90 degree hybrid tuned for the 0.82–0.90 GHz band. The monolithic circuitry is 100% passive and offers low loss, high isolation and exceptional phase/amplitude balance. It is available in the SOIC-8 leaded surface mount package.

Electrical Specifications at 25°C

Parameter	Min.	Typ.	Max.	Unit
Frequency	0.82		0.90	GHz
Insertion Loss ¹		.4	.5	dB
Isolation	25	30		dB
VSWR All Ports		1.15:1	1.2:1	
Amplitude Balance		±.5	±.8	dB
Phase Balance		±1.0	±2.0	Deg.

1. Less 3 dB power split.

Pin Out

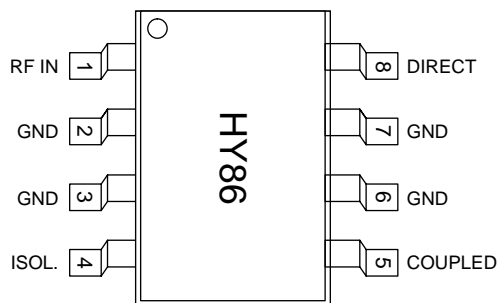

Block Diagram

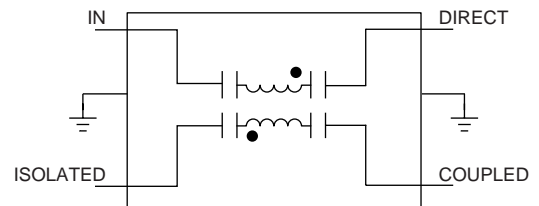

Typical Performance Data

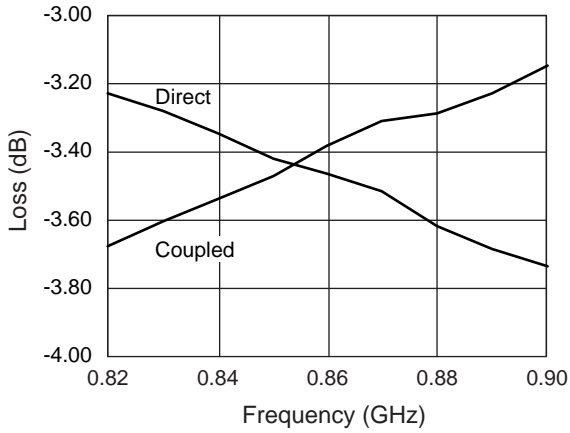

Path Losses vs. Frequency

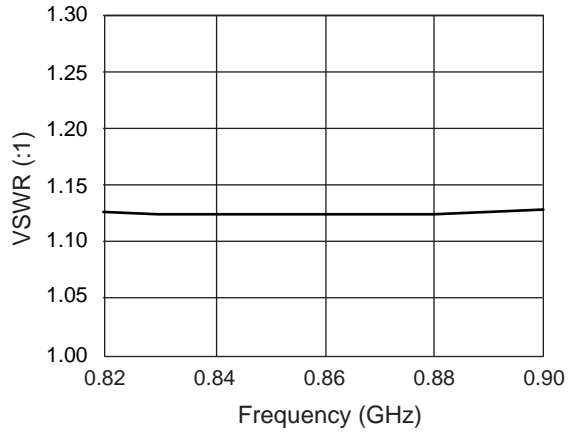

Input VSWR vs. Frequency

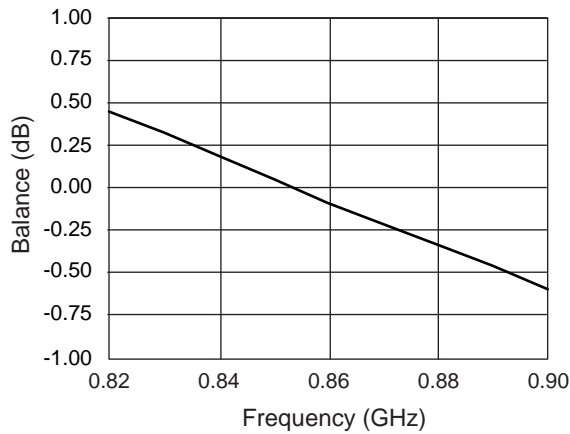

Amplitude Balance vs. Frequency

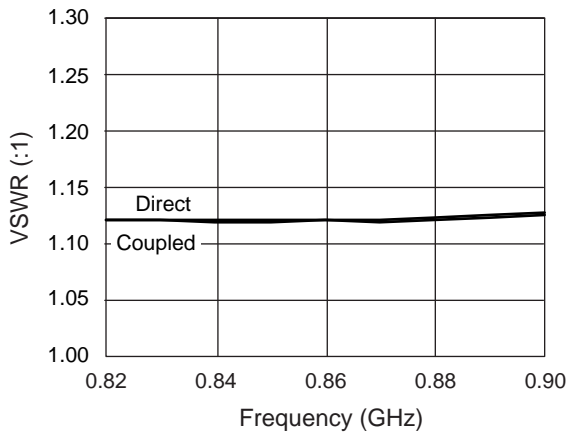

Output VSWR vs. Frequency

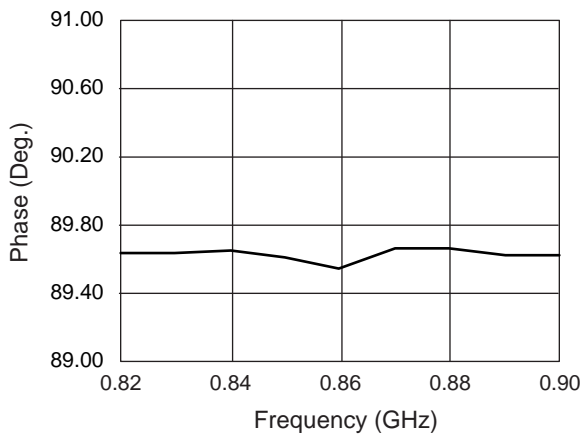

Coupled - Direct Phase vs. Frequency

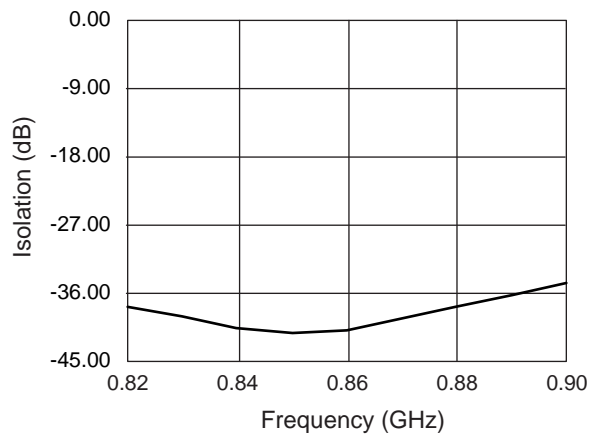

Isolation vs. Frequency

Absolute Maximum Ratings

Characteristic	Value
Input Power ¹	+4 W
Operating Temperature	-40°C to +85°C
Storage Temperature	-65°C to +150°C
Electrostatic Discharge	+125 V

1. Exceeding these parameters may cause irreversible damage.

Recommended Board Layout

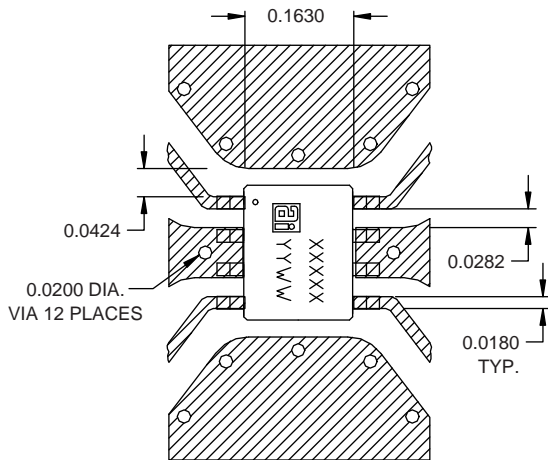

Materials 10 mil FR-4.
Dimensions are in inches.

SOIC-8

