



	IAD110P	Units
Load Voltage	350	V
Load Current	100	mA
Max R <sub>ON</sub>	35	Ω

### Features

- Three Functions in One Package
- Small 16 Pin SOIC Package (PCMCIA Compatible)
- Bi-Directional Current Sensing
- Bi-Directional Current Switching
- Replaces up to Three or Four Components
- 3750V<sub>RMS</sub> Input/Output Isolation
- FCC Compatible
- No EMI/RFI Generation
- Machine Insertable, Wave Solderable
- Tape & Reel Versions Available

### Applications

- Telecommunications
  - Telecom Switching
  - Tip/Ring Circuits
  - Modem Switching (Laptop, Notebook, Pocket Size)
  - Hookswitch
  - Dial Pulsing
  - Ground Start
  - Ringer Injection
- Instrumentation
  - Multiplexers
  - Data Acquisition
  - Electronic Switching
  - I/O Subsystems
  - Meters (Watt-Hour, Water, Gas)
- Medical Equipment-Patient/Equipment Isolation
- Security
- Aerospace
- Industrial Controls

### Description

The IAD110P Multifunction Telecom switch combines a 350V Form A relay and two optocouplers in a single package. The relay uses optically coupled MOSFET technology to provide 1500V of input to output isolation. The efficient MOSFET switch and photovoltaic die uses Clare's patented OptoMOS architecture. The optically coupled input uses highly efficient GaAIAs infrared LEDs. IAD110P's allow telecom circuit designers to combine three discrete functions in a single component. The IAD110P's small package uses less space than traditional discrete component solutions.

### Approvals

- UL Recognized: File Number E76270
- CSA Certified: File Number LR 43639-12
- VDE Compatible
- BSI Certified:
  - BS EN 60950:1992 (BS7002:1992) Certificate #:7969
  - BS EN 41003:1993 Certificate #:7969

### Ordering Information

Part #	Description
IAD110P	16 Pin SOIC (50/Tube)
IAD110PR	16 Pin SOIC (1000/Reel)

### Pin Configuration

Switching Characteristics of Normally Open (Form A) Devices

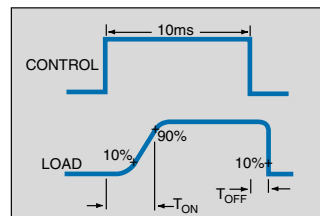

Switching Characteristics of Normally Closed (Form B) Devices

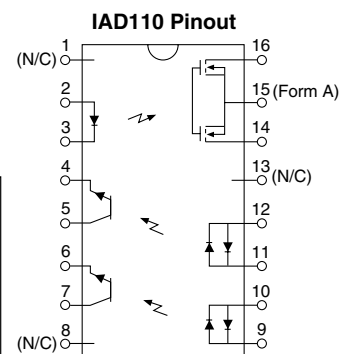
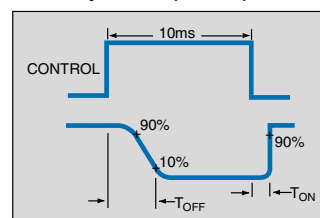

1. (N/C)
2. + LED - Relay Input
3. - LED - Relay Input
4. Emitter - Phototransistor #1
5. Collector - Phototransistor #1
6. Emitter - Phototransistor #2
7. Collector - Phototransistor #2
8. (N/C)
9. LED - Phototransistor +/- #2
10. LED - Phototransistor +/- #2
11. LED - Phototransistor +/- #1
12. LED - Phototransistor +/- #1
13. (N/C)
14. Output - Relay
15. Common - Relay
16. Output - Relay

### Absolute Maximum Ratings (@ 25° C)

Parameter	Min	Typ	Max	Units
Total Package Dissipation	-	-	1 <sup>1</sup>	W
Isolation Voltage Input to Output	3750	-	-	V <sub>RMS</sub>
Operational Temperature	-40	-	+85	°C
Storage Temperature	-40	-	+125	°C
Soldering Temperature (10 Seconds Max.)	-	-	+220	°C

<sup>1</sup> Above 25° derate linearly 1.67mw/°C

*Absolute Maximum Ratings are stress ratings. Stresses in excess of these ratings can cause permanent damage to the device. Functional operation of the device at these or any other conditions beyond those indicated in the operational sections of this data sheet is not implied. Exposure of the device to the absolute maximum ratings for an extended period may degrade the device and effect its reliability.*

### Electrical Characteristics

Parameter	Conditions	Symbol	Min	Typ	Max	Units
<b>Relay Portion</b>						
<b>Output Characteristics @ 25°C</b>						
Load Voltage (Peak)	I <sub>L</sub> = 1μA	V <sub>L</sub>	-	-	350	V
Load Current (Continuous)	-	I <sub>L</sub>	-	-	100	mA
Peak Load Current	10ms	I <sub>LPK</sub>	-	-	350	mA
On-Resistance	I <sub>L</sub> = 100mA	R <sub>ON</sub>	-	-	35	Ω
Off-State Leakage Current	V <sub>L</sub> = 350V; T <sub>J</sub> = 25°C	I <sub>LEAK</sub>	-	-	1	μA
Switching Speeds						
Turn-On	I <sub>F</sub> = 5mA, V <sub>L</sub> = 10V	T <sub>ON</sub>	-	-	3	ms
Turn-Off	I <sub>F</sub> = 5mA, V <sub>L</sub> = 10V	T <sub>OFF</sub>	-	-	3	ms
Output Capacitance	V <sub>L</sub> = 50V, f = 1MHz	-	-	25	-	pF
<b>Relay Portion</b>						
<b>Input Characteristics @ 25°C</b>						
Input Control Current	I <sub>L</sub> = 100mA	I <sub>F</sub>	5	-	50	mA
Input Dropout Current	I <sub>L</sub> = 1mA	I <sub>F</sub>	0.4	-	-	mA
Input Voltage Drop	I <sub>F</sub> = 5mA	V <sub>F</sub>	0.9	1.2	1.4	V
Reverse Input Voltage	-	V <sub>R</sub>	-	-	5	V
Reverse Input Current	V <sub>R</sub> = 5V	I <sub>R</sub>	-	-	10	μA
<b>Detector Portion</b>						
<b>Output Characteristics @ 25°C</b>						
Phototransistor Blocking Voltage	I <sub>C</sub> = 10μA	BV <sub>CEO</sub>	20	50	-	V
Phototransistor Dark Current	V <sub>CE</sub> = 5V, I <sub>F</sub> = 0mA	I <sub>CEO</sub>	-	50	500	nA
Saturation Voltage	I <sub>C</sub> = 2mA, I <sub>F</sub> = 16mA	V <sub>SAT</sub>	-	0.3	0.5	V
Current Transfer Ratio	I <sub>F</sub> = 6mA, V <sub>CE</sub> = 0.5V	C <sub>TR</sub>	33	-	-	%
<b>Detector Portion</b>						
<b>Input Characteristics @ 25°C</b>						
Input Control Current	I <sub>C</sub> = 2mA, V <sub>CE</sub> = 0.5V	I <sub>F</sub>	6	2	-	mA
Input Voltage Drop	I <sub>F</sub> = 5mA	I <sub>CEO</sub>	0.9	1.2	1.4	V
Input Current (Detector must be off)	I <sub>C</sub> = 1μA, V <sub>CE</sub> = 5V	-	5	25	-	μA
Input to Output Capacitance	V <sub>L</sub> = 50V, f = 1MHz	C <sub>I/O</sub>	-	3	-	pF
Input to Output Isolation	-	V <sub>I/O</sub>	3750	-	-	V <sub>RMS</sub>

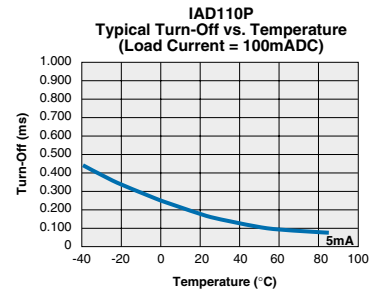
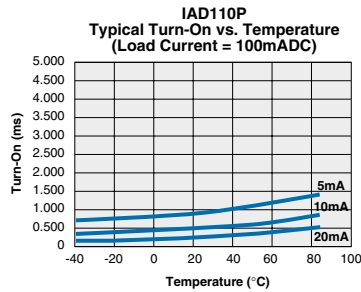
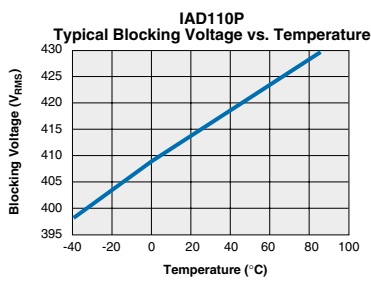
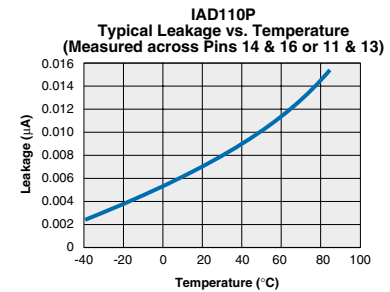
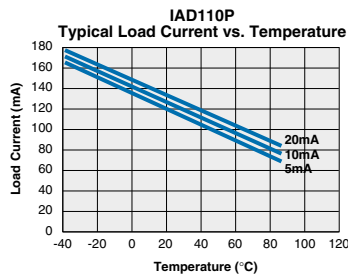
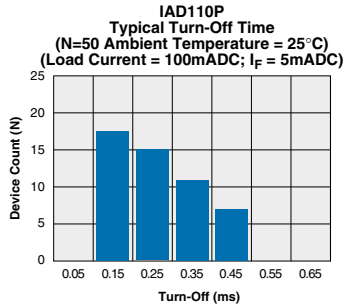
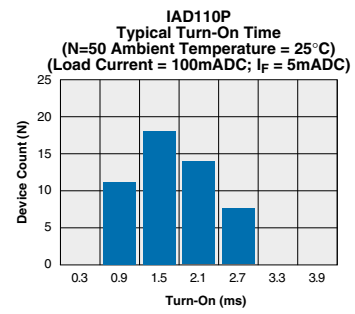
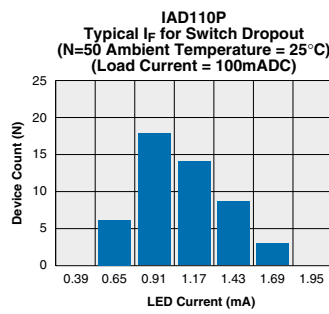
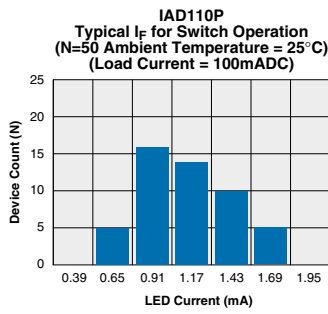
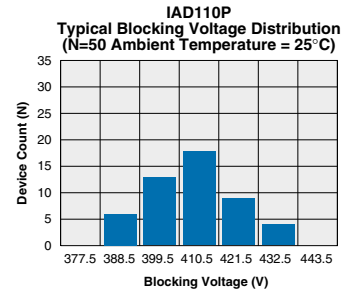
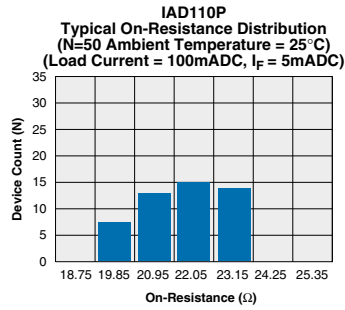
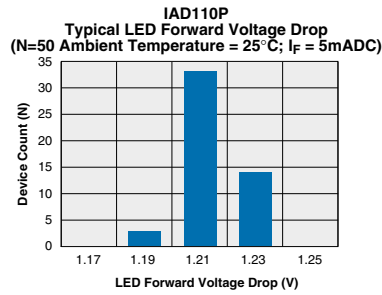
**PERFORMANCE DATA\***

The Performance data shown in the graphs above is typical of device performance. For guaranteed parameters not indicated in the written specifications, please contact our application department.

PERFORMANCE DATA\*

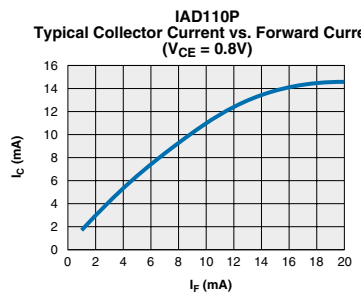
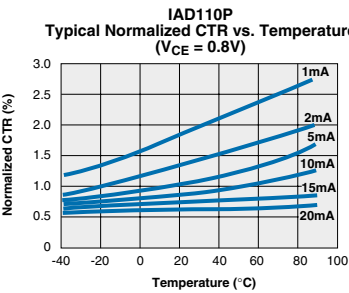
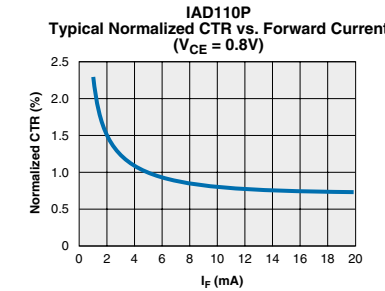
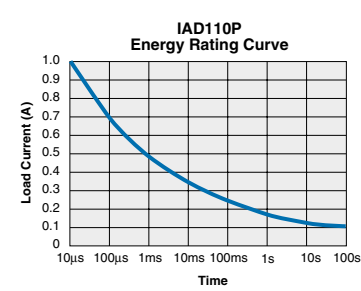
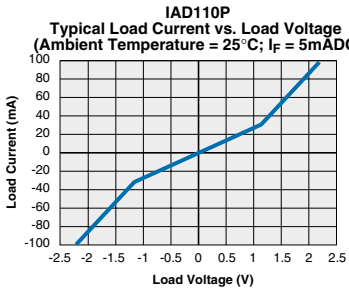
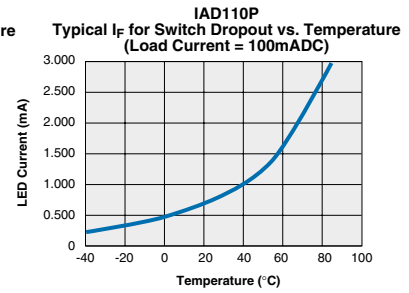
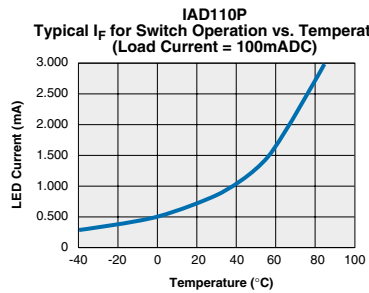
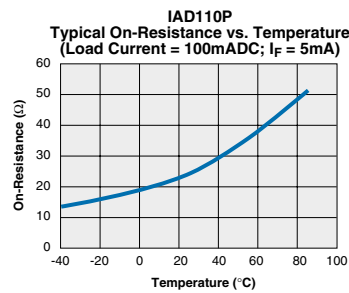
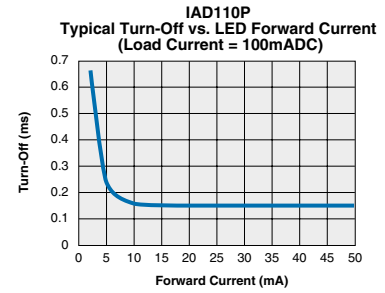
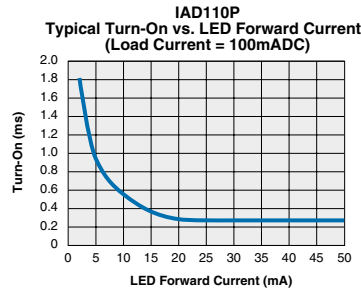
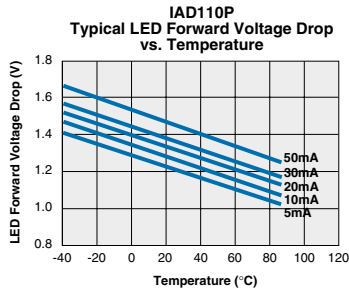

\*The Performance data shown in the graphs above is typical of device performance. For guaranteed parameters not indicated in the written specifications, please contact our application department.

Mechanical Dimensions

16 Pin SOIC ("P" Suffix)

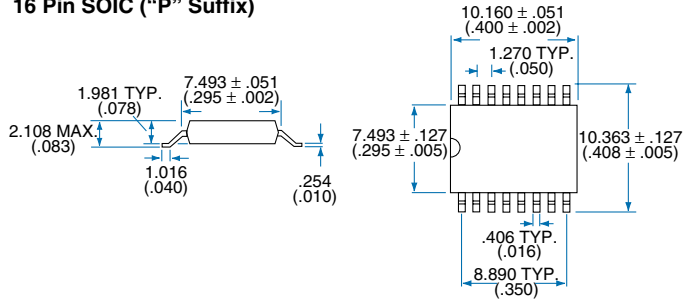

PC Board Pattern (Top View)

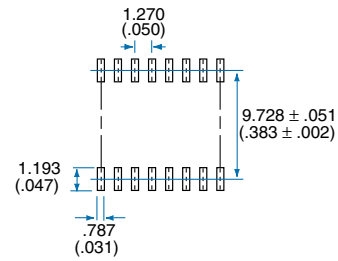

Tape and Reel Packaging for 16 Pin SOIC Package

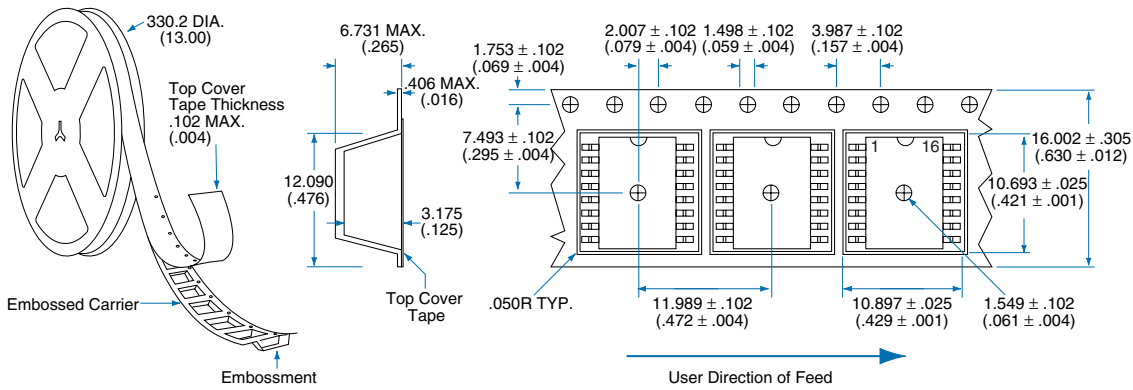

Dimensions  
mm  
(inches)

**CLARE LOCATIONS**

Clare Headquarters  
78 Cherry Hill Drive  
Beverly, MA 01915  
Tel: 1-978-524-6700  
Fax: 1-978-524-4900  
Toll Free: 1-800-27-CLARE

Clare Micronix Division  
145 Columbia  
Aliso Viejo, CA 92656-1490  
Tel: 1-949-831-4622  
Fax: 1-949-831-4628

**SALES OFFICES**

**AMERICAS**

**Americas Headquarters**

Clare  
78 Cherry Hill Drive  
Beverly, MA 01915  
Tel: 1-978-524-6700  
Fax: 1-978-524-4900  
Toll Free: 1-800-27-CLARE

**Eastern Region**

Clare  
P.O. Box 856  
Mahwah, NJ 07430  
Tel: 1-201-236-0101  
Fax: 1-201-236-8685  
Toll Free: 1-800-27-CLARE

**Central Region**

Clare Canada Ltd.  
3425 Harvester Road, Suite 202  
Burlington, Ontario L7N 3N1  
Tel: 1-905-333-9066  
Fax: 1-905-333-1824

**Western Region**

Clare  
1852 West 11th Street, #348  
Tracy, CA 95376  
Tel: 1-209-832-4367  
Fax: 1-209-832-4732  
Toll Free: 1-800-27-CLARE

**Canada**

Clare Canada Ltd.  
3425 Harvester Road, Suite 202  
Burlington, Ontario L7N 3N1  
Tel: 1-905-333-9066  
Fax: 1-905-333-1824

**EUROPE**

**European Headquarters**

CP Clare nv  
Bampslaan 17  
B-3500 Hasselt (Belgium)  
Tel: 32-11-300868  
Fax: 32-11-300890

**France**

Clare France Sales  
Lead Rep  
99 route de Versailles  
91160 Champlan  
France  
Tel: 33 1 69 79 93 50  
Fax: 33 1 69 79 93 59

**Germany**

Clare Germany Sales  
ActiveComp Electronic GmbH  
Mitterstrasse 12  
85077 Manching  
Germany  
Tel: 49 8459 3214 10  
Fax: 49 8459 3214 29

**Italy**

C.L.A.R.E.s.a.s.  
Via C. Colombo 10/A  
I-20066 Melzo (Milano)  
Tel: 39-02-95737160  
Fax: 39-02-95738829

**Sweden**

Clare Sales  
Comptronic AB  
Box 167  
S-16329 Spånga  
Tel: 46-862-10370  
Fax: 46-862-10371

**United Kingdom**

Clare UK Sales  
Marco Polo House  
Cook Way  
Bindon Road  
Taunton  
UK-Somerset TA2 6BG  
Tel: 44-1-823 352541  
Fax: 44-1-823 352797

**ASIA/PACIFIC**

**Asian Headquarters**

Clare  
Room N1016, Chia-Hsin, Bldg II,  
10F, No. 96, Sec. 2  
Chung Shan North Road  
Taipei, Taiwan R.O.C.  
Tel: 886-2-2523-6368  
Fax: 886-2-2523-6369

<http://www.clare.com>

---

*Clare cannot assume responsibility for use of any circuitry other than circuitry entirely embodied in this Clare product. No circuit patent licenses nor indemnity are expressed or implied. Clare reserves the right to change the specification and circuitry, without notice at any time. The products described in this document are not intended for use in medical implantation or other direct life support applications where malfunction may result in direct physical harm, injury or death to a person.*

---