

ICE13N65 N-Channel Enhancement Mode MOSFET

RoHS
compliant
2011/65/EU



HALOGEN
FREE

| Product Summary | | | |
|-----------------|------------------------|--------------|-----|
| I_D | $T_A=25^\circ\text{C}$ | 13A | Max |
| $V_{(BR)DSS}$ | $I_D=250\mu\text{A}$ | 650V | Min |
| $r_{DS(on)}$ | $V_{GS}=10\text{V}$ | 0.24Ω | Typ |
| Q_g | $V_{DS}=480\text{V}$ | 57nC | Typ |

Features

- Low $r_{DS(on)}$
- Ultra Low Gate Charge
- High dv/dt capability
- High Unclamped Inductive Switching (UIS) capability
- High peak current capability
- Increased transconductance performance
- Optimized design for high performance power systems

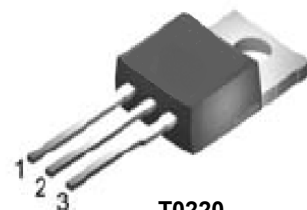
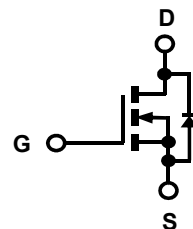

T0220

Standard Metal
Heatsink

1=Gate, 2=Drain,
3=Source.

ICEMOS AND ITS SISTER COMPANY 3D SEMI OWN THE FUNDAMENTAL PATENTS FOR SUPERJUNCTION MOSFETS. THE MAJORITY OF THESE PATENTS HAVE 17 to 20 YEARS OF REMAINING LIFE. THIS PORTFOLIO HAS GRANTED PATENTS ISSUED IN USA, CHINA, KOREA, JAPAN, TAIWAN & EUROPE.

Maximum ratings at $T_j=25^\circ\text{C}$, unless otherwise specified

| Parameter | Symbol | Conditions | Value | Unit |
|-----------------------------------|----------------|--|-------------|------------------|
| Continuous drain current | I_D | $T_c=25^\circ\text{C}$ $T_c=100^\circ\text{C}$ | 13 9 | A |
| Pulsed drain current | $I_{D, pulse}$ | $T_c=25^\circ\text{C}$ | 39 | A |
| Avalanche energy, single pulse | E_{AS} | $I_D=7.5\text{A}$ | 460 | mJ |
| Avalanche current, repetitive | I_{AR} | limited by $T_j\text{max}$ | 7.5 | A |
| MOSFET dv/dt ruggedness | dv/dt | $V_{DS}=480\text{V}$, $I_D=13\text{A}$, $T_j=125^\circ\text{C}$ | 50 | V/ns |
| Gate source voltage | V_{GS} | Static | ± 20 | V |
| | | AC ($f>1\text{Hz}$) | ± 30 | |
| Power dissipation | P_{tot} | $T_c=25^\circ\text{C}$ | 156 | W |
| Operating and storage temperature | T_j, T_{stg} | | -55 to +150 | $^\circ\text{C}$ |
| Mounting torque | | M3 & 3.5 screws | 60 | Ncm |

a When mounted on 1inch square 2oz copper clad FR-4

| Parameter | Symbol | Conditions | Values | | | Unit |
|---|------------|-------------------------------------|--------|-----|-----|------|
| | | | Min | Typ | Max | |
| Thermal characteristics | | | | | | |
| Thermal resistance, junction-case ^a | R_{thJC} | | - | - | 0.8 | °C/W |
| Thermal resistance, junction-ambient ^a | R_{thJA} | leaded | - | - | 62 | |
| Soldering temperature, wave soldering only allowed at leads | T_{sold} | 1.6mm (0.063in.) from case for 10 s | - | - | 260 | °C |

Electrical characteristics at $T_j=25^{\circ}\text{C}$, unless otherwise specified

Static characteristics

| | | | | | | |
|----------------------------------|---------------|---|-----|------|------|---------------|
| Drain-source breakdown voltage | $V_{(BR)DSS}$ | $V_{GS}=0\text{ V}, I_D=250\mu\text{A}$ | 650 | 675 | - | V |
| Gate threshold voltage | $V_{GS(th)}$ | $V_{DS}=V_{GS}, I_D=250\mu\text{A}$ | 2.1 | 3.2 | 3.9 | |
| Zero gate voltage drain current | I_{DSS} | $V_{DS}=650\text{V}, V_{GS}=0\text{V}, T_j=25^{\circ}\text{C}$ | - | 0.1 | 1 | μA |
| | | $V_{DS}=650\text{V}, V_{GS}=0\text{V}, T_j=150^{\circ}\text{C}$ | - | 50 | - | |
| Gate source leakage current | I_{GSS} | $V_{GS}=\pm 20\text{ V}, V_{DS}=0\text{V}$ | - | - | 100 | nA |
| Drain-source on-state resistance | $r_{DS(on)}$ | $V_{GS}=10\text{V}, I_D=6.5\text{A}, T_j=25^{\circ}\text{C}$ | - | 0.24 | 0.28 | Ω |
| | | $V_{GS}=10\text{V}, I_D=6.5\text{A}, T_j=150^{\circ}\text{C}$ | - | 0.65 | - | |
| Gate resistance | R_G | $f=1\text{ MHz}, \text{open drain}$ | - | 4.1 | - | Ω |

Dynamic characteristics

| | | | | | | |
|------------------------------|--------------|---|---|------|---|----|
| Input capacitance | C_{iss} | $V_{GS}=0\text{ V}, V_{DS}=25\text{ V}, f=1\text{ MHz}$ | - | 1734 | - | pF |
| Output capacitance | C_{oss} | | - | 200 | - | |
| Reverse transfer capacitance | C_{rss} | | - | 2.5 | - | |
| Transconductance | g_{fs} | $V_{DS}>2*I_D*R_{DS}, I_D=6.5\text{A}$ | - | 15 | - | S |
| Turn-on delay time | $t_{d(on)}$ | $V_{DS}=380\text{V}, V_{GS}=10\text{V}, I_D=13\text{A}, R_G=4\Omega \text{ (External)}$ | - | 33 | - | ns |
| Rise time | t_r | | - | 42 | - | |
| Turn-off delay time | $t_{d(off)}$ | | - | 105 | - | |
| Fall time | t_f | | - | 27 | - | |

| Parameter | Symbol | Conditions | Values | | | Unit |
|-----------|--------|------------|--------|-----|-----|------|
| | | | Min | Typ | Max | |

Gate charge characteristics

| | | | | | | |
|-----------------------|---------------|---|---|------|---|----|
| Gate to source charge | Q_{gs} | $V_{DS}=480\text{ V}, I_D=13\text{ A},$ $V_{GS}=0\text{ to }10\text{ V}$ | - | 9.5 | - | nC |
| Gate to drain charge | Q_{gd} | | - | 21.4 | - | |
| Gate charge total | Q_g | | - | 57 | - | |
| Gate plateau voltage | $V_{plateau}$ | | - | 5.3 | - | V |

Reverse Diode

| | | | | | | |
|-------------------------------|----------|---|---|------|-----|---------------|
| Continuous forward current | I_S | $V_{GS}=0\text{ V}$ | - | - | 13 | A |
| Diode forward voltage | V_{SD} | $V_{GS}=0\text{ V}, I_S=I_F$ | - | 0.9 | 1.2 | V |
| Reverse recovery time | t_{rr} | $V_{RR}=50\text{ V}, I_S=I_F,$ $d_{iF}/d_t=100\text{ A}/\mu\text{S}$ | - | 327 | - | ns |
| Reverse recovery charge | Q_{rr} | | - | 5.3 | - | μC |
| Peak reverse recovery current | I_{rm} | | - | 29.7 | - | A |

Output Characteristics

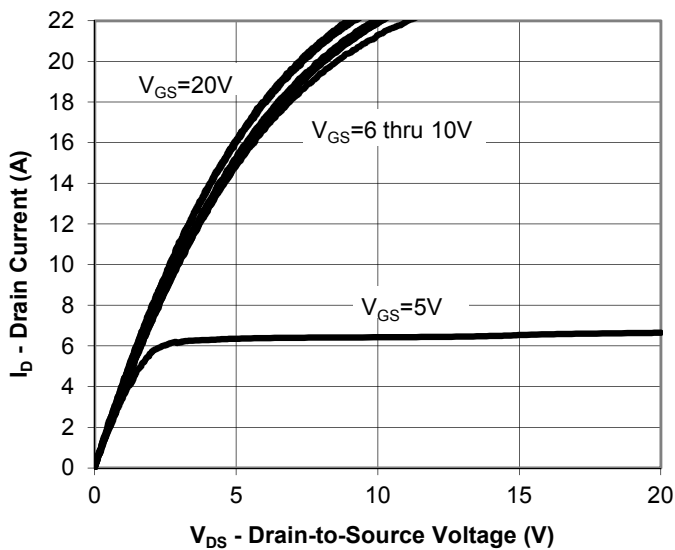

Transfer Characteristics

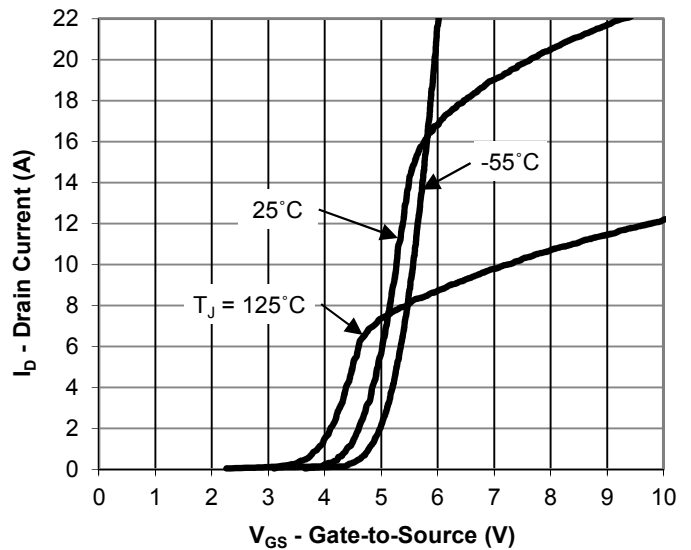

Drain-Source On-State Resistance vs. Drain Current

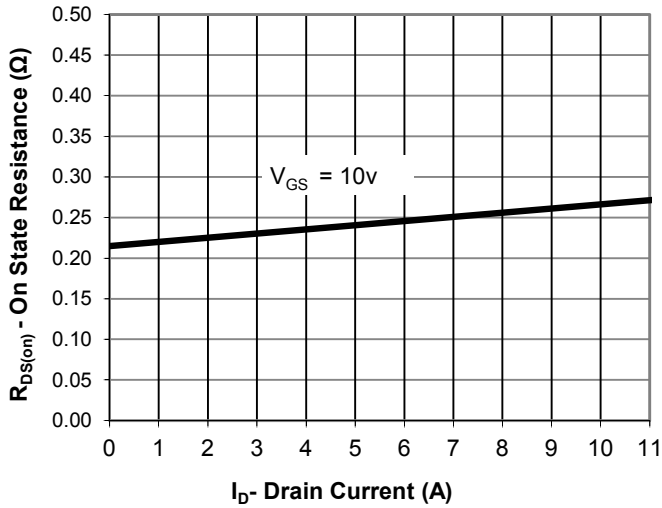

Drain-Source On-State Resistance vs. Gate-to-Source Voltage

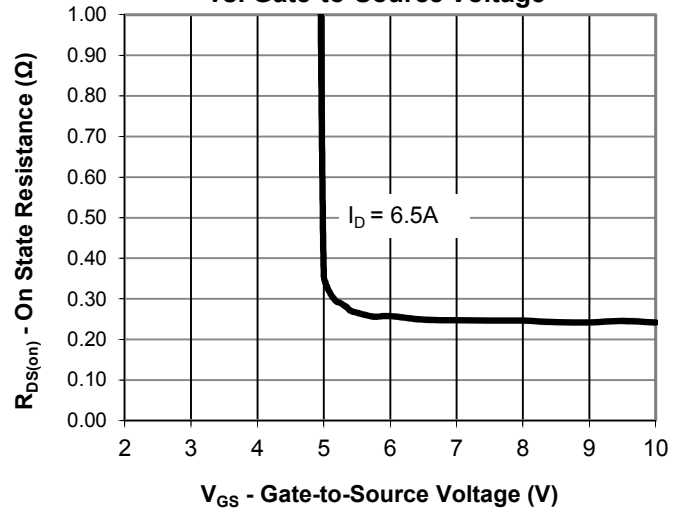

Drain-Source On State Resistance vs. Junction Temperature

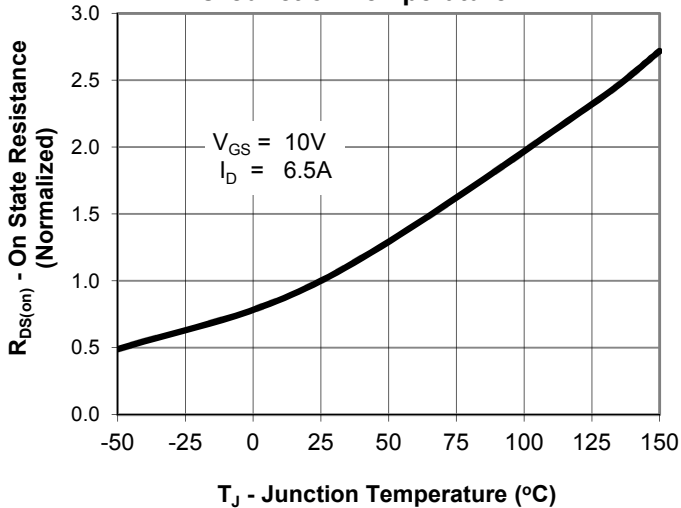

Gate Threshold Voltage vs. Junction Temperature

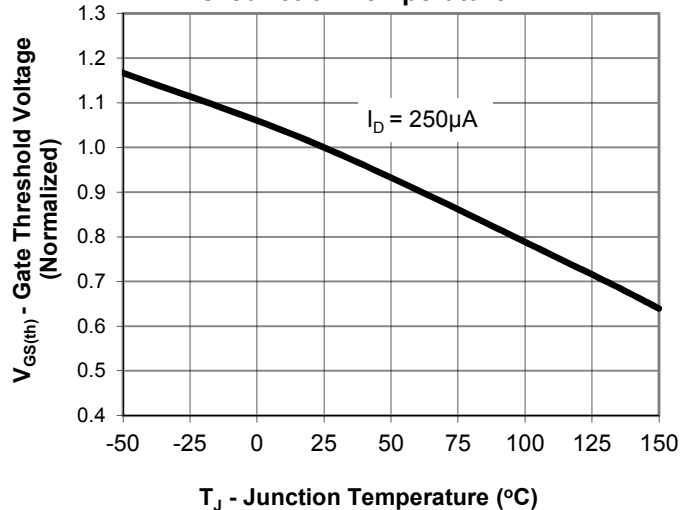

Gate Charge

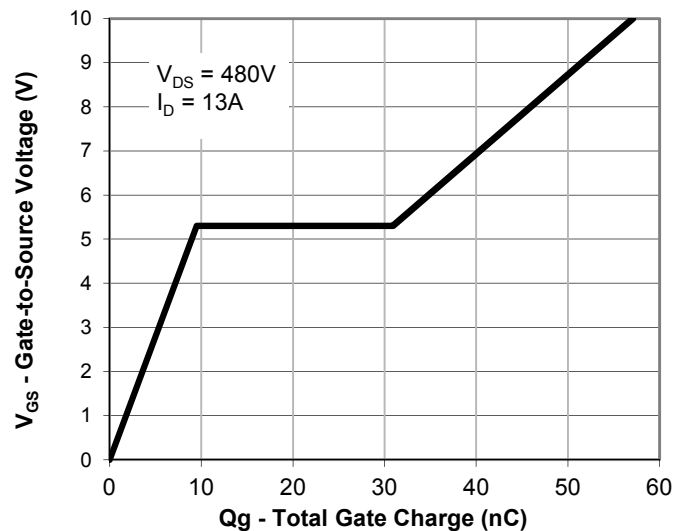

Drain-to-Source Breakdown Voltage vs. Junction Temperature

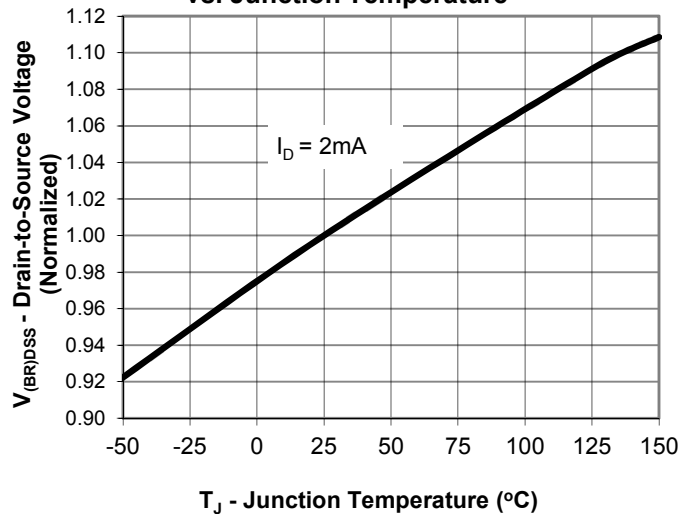



Capacitance

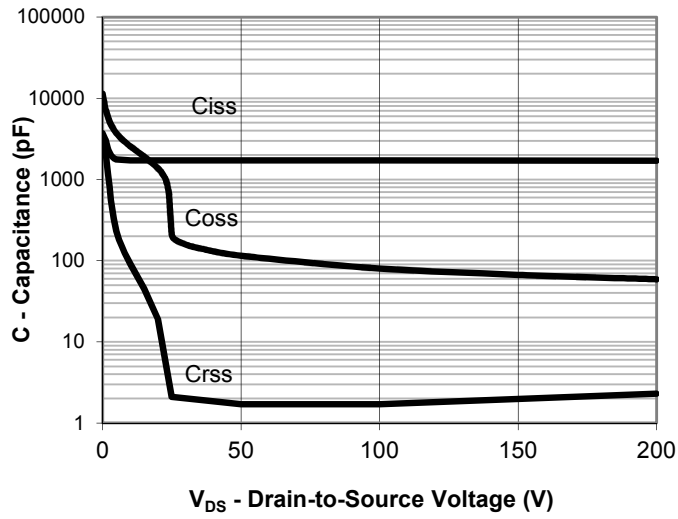

Source-Drain Diode Forward Voltage

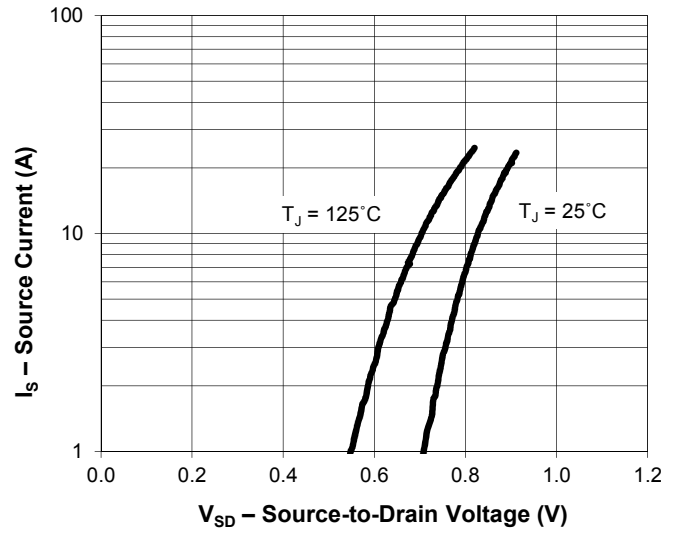

Maximum Rated Forward Biased Safe Operating Area

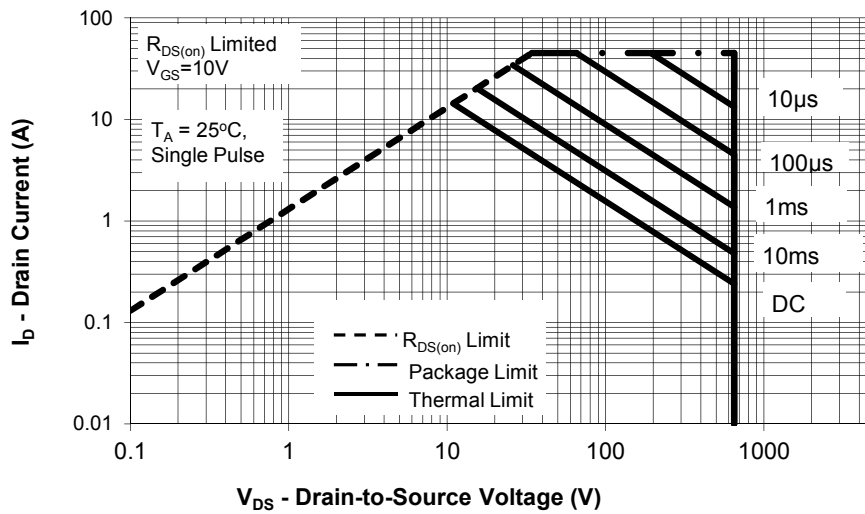

Transient Thermal Response, Junction-to-Ambient

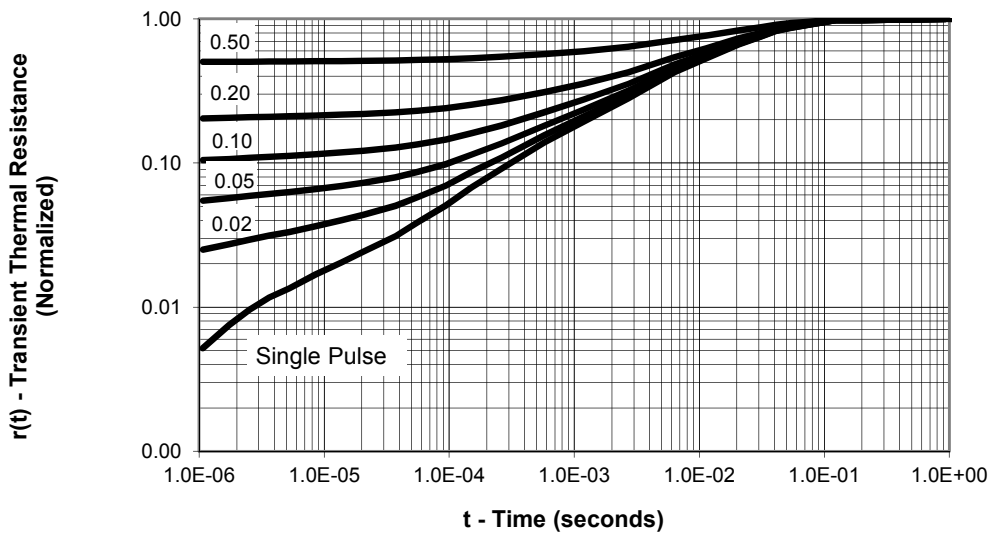

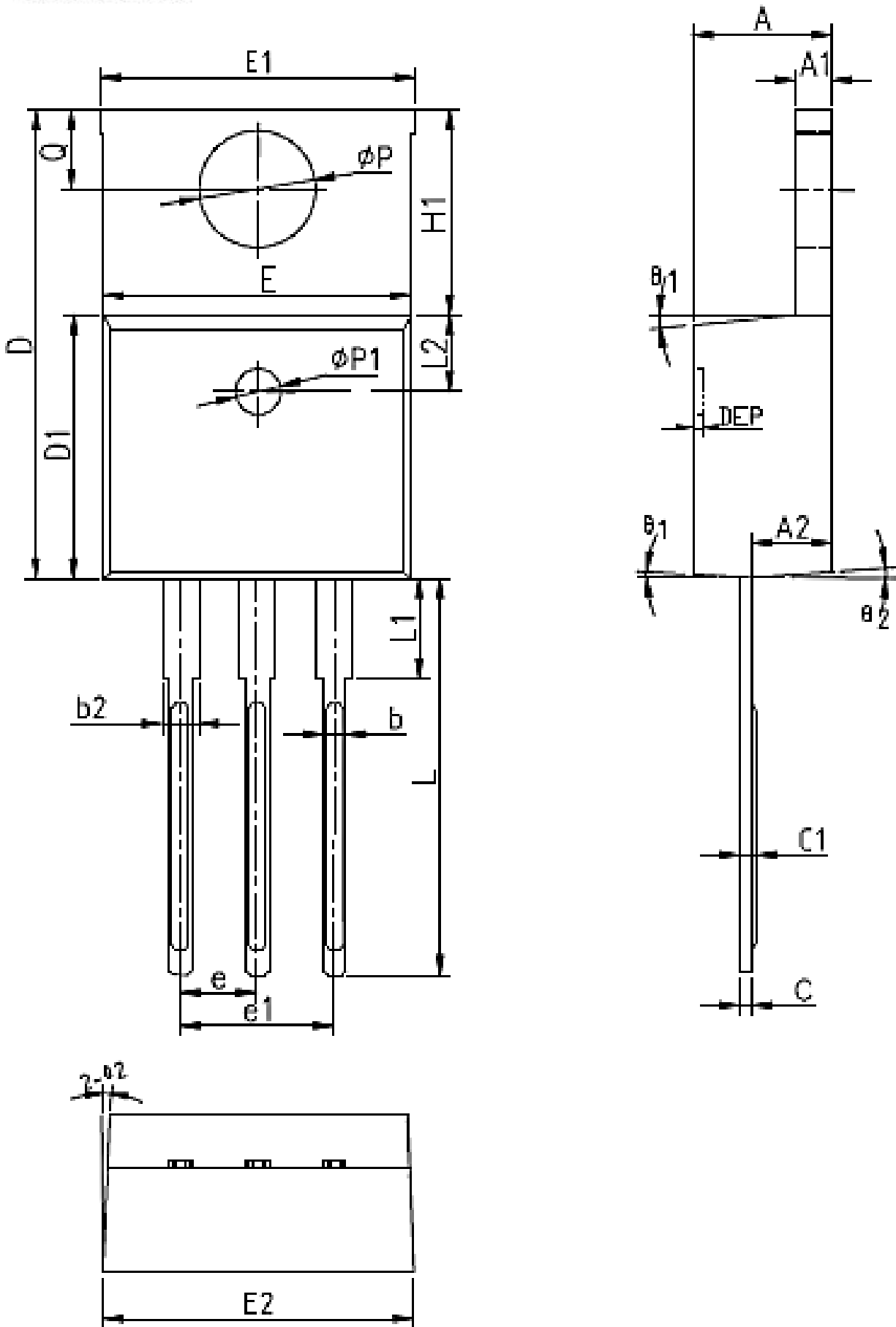

| COMMON DIMENSIONS | | | | | | |
|-------------------|----------|--------|--------|-----------|-------|-------|
| SYMBOL | MM | | | INCH | | |
| | MIN | NOM | MAX | MIN | NOM | MAX |
| A | 3.556 | 4.191 | 4.826 | 0.140 | 0.165 | 0.190 |
| A1 | 0.508 | 1.397 | 1.40 | 0.020 | 0.055 | 0.055 |
| A2 | 2.032 | 2.476 | 2.921 | 0.080 | 0.097 | 0.115 |
| b | 0.356 | 0.633 | 0.91 | 0.014 | 0.025 | 0.036 |
| b2 | 1.05 | 1.21 | 1.37 | 0.041 | 0.048 | 0.054 |
| c | 0.31 | 0.46 | 0.61 | 0.012 | 0.018 | 0.024 |
| c1 | 0.33 | 0.465 | 0.60 | 0.013 | 0.018 | 0.024 |
| D | 14.224 | 15.367 | 16.51 | 0.560 | 0.605 | 0.650 |
| D1 | 8.382 | 8.816 | 9.25 | 0.330 | 0.347 | 0.364 |
| E | 9.652 | 10.16 | 10.668 | 0.380 | 0.400 | 0.420 |
| E1 | 10.10 | 10.25 | 10.35 | 0.398 | 0.404 | 0.407 |
| E2 | 10.00 | 10.10 | 10.20 | 0.394 | 0.398 | 0.402 |
| e | 2.54 BSC | | | 0.100 BSC | | |
| e1 | 5.08 BSC | | | 0.200 BSC | | |
| H1 | 5.842 | 6.35 | 6.858 | 0.230 | 0.250 | 0.270 |
| L | 12.70 | 13.716 | 14.732 | 0.500 | 0.540 | 0.580 |
| L1 | 3.56 | 5.145 | 6.35 | 0.140 | 0.203 | 0.250 |
| L2 | 2.50 REF | | | 0.098 REF | | |
| ΦP | 3.55 | 3.72 | 3.89 | 0.140 | 0.146 | 0.153 |
| Q | 2.54 | 2.997 | 3.048 | 0.102 | 0.108 | 0.114 |
| θ1 | 5° | 7° | 9° | 5° | 7° | 9° |
| θ2 | 1° | 3° | 5° | 1° | 3° | 5° |
| ΦP1 | 1.40 | 1.75 | 2.10 | 0.055 | 0.069 | 0.083 |
| DEP | 0.05 | 0.10 | 0.20 | 0.002 | 0.004 | 0.008 |

ICEMOS SUPERJUNCTION PATENT PORTFOLIO

ICEMOS GRANTED PATENTS

US7,429,772

US7,439,178

US7,446,018

US7,579,607

US7,723,172

US7,795,045

US7,846,821

US7,944,018

US8,012,806

US8,030,133

3D SEMI PATENTS LICENSED TO ICEMOS

US7,041,560B2

US7,023,069B2

US7,364,994

US7,227,197B2

US7,304,944B2

US7,052,982B2

US7,339,252

US7,410,891

US7,439,583

US7,227,197B2

US6,635,906

US6,936,867

US7,015,104

US9,109,110

US7,271,067

US7,354,818

US7,052,982,

US7,199,006B2

Note: additional patents in China, Korea, Japan, Taiwan, Europe have also been granted to IceMOS and 3D Semi for Superjunction MOSFETs with 70 additional Patent applications in process in the USA and the above listed countries.

Marking Information

YY = Last two digits of the year

WW = Work week calendar on Icemos subcon assembly & test house

***** = Initial for Icemos subcon assembly and test house

XXXXXX = Lot ID

ICE13N65 = ICE is Icemos logo and 13N65 is a designated device part number

