

SONY

3-751-155-22 (1)

LW/MW/SW/FM Stereo
PLL Synthesized Receiver

ICF-SW7600

Operating Instructions

page 2

Before operating the unit, please read this manual thoroughly and retain it for future reference.

Owner's Record

The model number is located on the front panel and the serial number is under the rear stand. Record the serial number in the space provided below. Refer to these numbers whenever you call upon your Sony dealer regarding this product.

Model No. ICF-SW7600

Serial No. _____

PROPERTY OF THE
NATIONAL TECHNICAL DEPT.

Mode d'emploi

page 36

Avant de faire fonctionner cet appareil, prière de lire attentivement ce mode d'emploi et de le conserver à titre de référence ultérieure.

FILE COPY

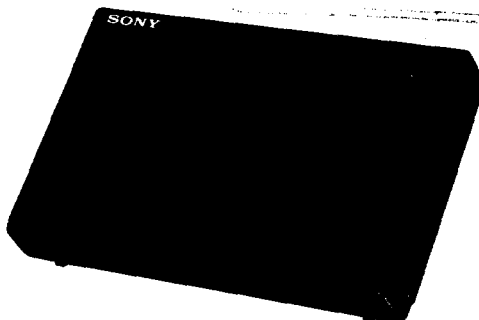

©1989 by Sony Corporation

WARNING

To prevent fire or shock hazard, do not expose the unit to rain or moisture.

To avoid electrical shock, do not open the cabinet. Refer servicing to qualified personnel only.

INFORMATION

This equipment generates and uses radio frequency energy and if not installed and used properly, that is, in strict accordance with the manufacturer's instructions, may cause interference to radio and television reception. It has been type tested and found to comply with the limits for a Class B computing device in accordance with the specifications in Subpart J of Part 15 of FCC Rules, which are designed to provide reasonable protection against such interference in a residential installation. However, there is no guarantee that interference will not occur in a particular installation. If this equipment does cause interference to radio or television reception, which can be determined by turning the equipment off and on, the user is encouraged to try to correct the interference by one or more of the following measures:

- Reorient the receiving antenna
- Relocate the equipment with respect to the receiver
- Move the equipment away from the receiver
- Plug the equipment into a different outlet so that equipment and receiver are on different branch circuits.

If necessary, the user should consult the dealer or an experienced radio/television technician for additional suggestions. The user may find the following booklet prepared by the Federal Communications Commission helpful:
 "How to Identify and Resolve Radio-TV Interference Problems". This booklet is available from the U.S. Government Printing Office, Washington, DC 20402, Stock No. 004-000-00345-4.

For the customers in Canada

This apparatus complies with the Class B limits for radio noise emissions set out in Radio Interference Regulations.

Table of Contents

Features	●
Precautions	●
Location and function of controls	●
Power sources	●
Batteries	●
House current	●
12 V car battery	●
How to set the clock	●
How to change the MW channel step	●
Direct tuning	●
Manual tuning	●
Scan tuning	●
Preset tuning	●
How to preset a station	●
To tune in a preset station	●
How to tune in precisely	●
How to tune in SSB transmissions	●
Having the radio turned on automatically	●
How to set the sleep timer	●
How to use the supplied SW compact antenna	●
How to use an optional antenna	●
Using the supplied antenna connector	●
For FM reception	●
For AM reception	●
Recording radio programs	●
To start recording at a desired time	●
Specifications	●
Troubleshooting guide	●

Features

Refer to the pages indicated in ● for details.

- An LW/MW/SW/FM stereo receiver with world-wide band coverage.
- Quartz controlled PLL (Phase Locked Loop) synthesizer system using a microcomputer for easy pinpoint tuning. The tuned frequency is digitally displayed.
- Fine tuning control for precise tuning ●
- SSB (Single side band) can be received ●
- Provided with a recording output and a remote control jack. Connecting the unit to the optional Sony TCM-27 cassette-corder using these jacks, you can start recording programs at a desired time ●.
- Various ways of tuning
 - Direct tuning** ... Tuning in the station by inputting the frequency of the station directly ●
 - Manual tuning** ... Even if you don't know the frequency of the station, you can tune in the station precisely ●
 - Scan tuning** ... An automatic searching of a station ●
 - Preset tuning** ... Up to 10 stations can be preset for button-touch tuning ●
- Other features
 - Timer standby** ... The function to receive a desired station at a desired time ●
 - Sleep timer** ... Turning the radio off automatically in 65 minutes ●
 - Power sources** ... Three different power sources: internal batteries, house current, car battery ●

Precautions

- Operate the unit only on 6 V DC.
 - For battery operation, use four size AA (R6) batteries.
 - For AC operation, use the AC power adaptor supplied with this unit; do not use any other type.
 - For car battery operation, use the car battery cord recommended for this unit; do not use any other type.
- Do not leave the unit in a location near heat sources, or in a place subject to direct sunlight, excessive dust, or mechanical shock.
- Use the unit within a temperature range of 0°C to 40°C (32°F to 104°F). If it is used in temperatures outside this range, there may be trouble with the frequency and clock display. If it is used in temperatures lower than this range, the displayed numbers may change very slowly. This is not an internal malfunction. The display will recover when the unit is used within the recommended temperature.
- Should any solid object or liquid fall into the unit, remove the batteries, and have the unit checked by qualified personnel before operating it any further.
- Since a strong magnet is used for the speaker, keep personal credit cards using magnetic coding or spring-wound watches away from the unit to prevent them from possible damage caused by the magnet.
- Reception around 1.8 MHz and 3.6 MHz may be difficult because of internal spurious signals generated by the built-in oscillators.
- When the casing becomes soiled, clean it with a soft cloth dampened with mild detergent solution. Never use abrasive cleansers or chemical solvents, as they may mar the casing.

If you have any question or problem concerning your unit that is not covered in this manual, please consult the nearest Sony dealer.

Location and Function of Controls

Refer to the pages indicated in ● for details.

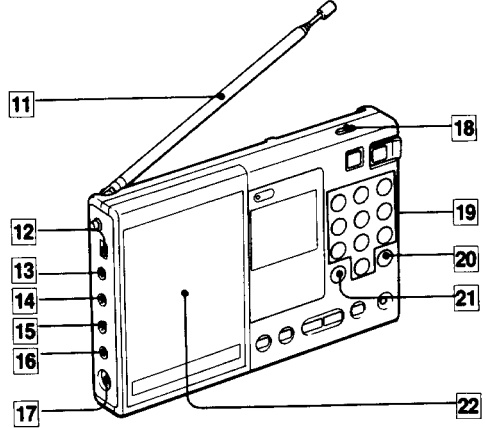
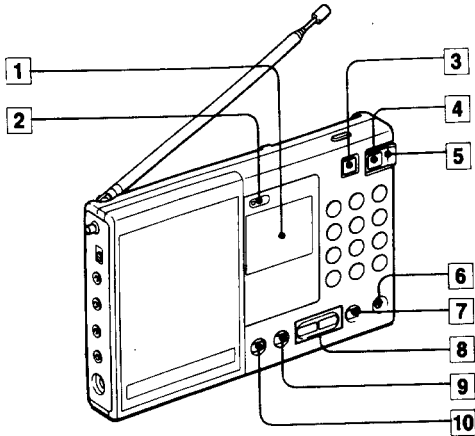

www.DataSheet4U.com

- 1 Display window
- 2 TUNE (tuning) indicator
Lights up when a station is tuned in.
- 3 SLEEP (sleep timer) button ●
- 4 ON/OFF (power) button
- 5 POWER/LOCK switch
Set this switch to POWER, then press the ON/OFF button to turn on the radio. Set the switch to LOCK when carrying the radio. When this switch is set to LOCK, the power will not be turned on even if you press the ON/OFF button.
- 6 KEY PROTECT button ●
- 7 SCAN TUNING START STOP/STANDBY button ● ●
- 8 MANUAL TUNING/SET button ● ● ●
- 9 BAND/ALARM (alarm set) button ● ● ●
- 10 ENTER/TIME (time set) button ● ●

- 11 Telescopic antenna
- 12 SENS DX • LOCAL (FM/AM sensitivity) selector ●
- 13 EXT ANT (external antenna) jack
- 14 TAPE REMOTE jack ●
- 15 TAPE REC OUT jack ●
- 16 (headphones) jack
- 17 DC IN 6 V (external power input) jack
- 18 LIGHT button
Press to illuminate the display window for about 15 seconds.
- 19 PRESET/DIRECT TUNING buttons ● ●
- 20 FM/EXECUTE button ●
- 21 AM/EXECUTE button ●
- 22 Speaker

Location and Function of Controls

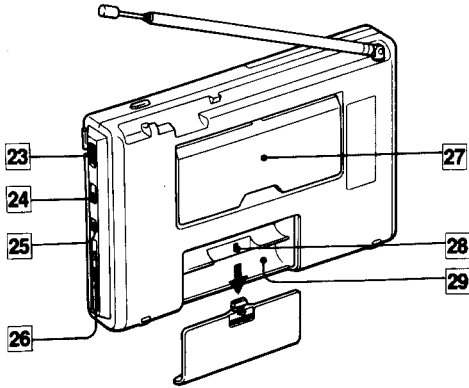

How to use the stand

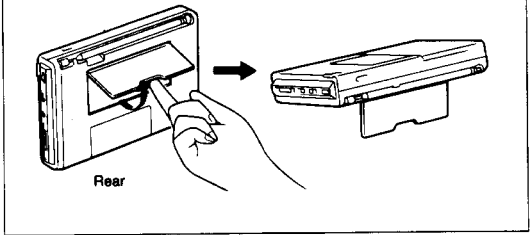

www.DataSheet4U.com

- 23 FINE TUNING control ● ●
- 24 AM MODE selector ● ●
- 25 TONE selector ●
MUSIC: for listening to music
NEWS: for listening to news
- 26 VOLUME control
- 27 Stand
- 28 MW CH STEP (MW channel step) selector ●
- 29 Battery compartment

Power Sources

Before installing the batteries, be sure to check that the MW CH STEP selector is set correctly (see page 6).

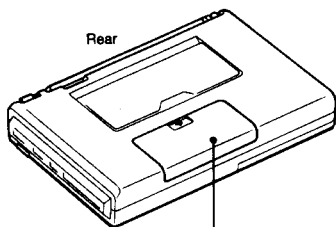

Four size AA (R6) batteries.

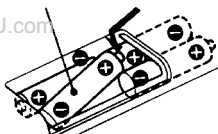

Battery replacement

Replace all the batteries with new ones when the sound becomes weak or distorted.

Do it within ten minutes since the preset stations and the current time will be erased when more than ten minutes have passed.

If they are erased, preset the stations and set the time again.

For the customers in the U.S.A.

Use the supplied AC-D4M AC power adaptor.

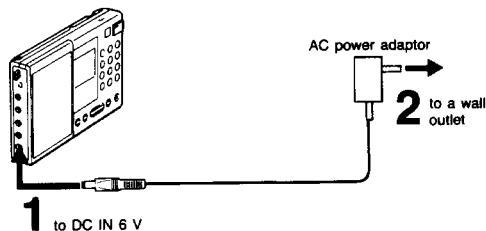

For the customers in Canada

Use the supplied AC-240 AC power adaptor. The adaptor operates on either 110 (99 - 121)*, 120 (108 - 132), 220 (198 - 242), or 240 V (216 - 264 V) AC, 50/60 Hz.

* Range of voltage allowable shown in parentheses.

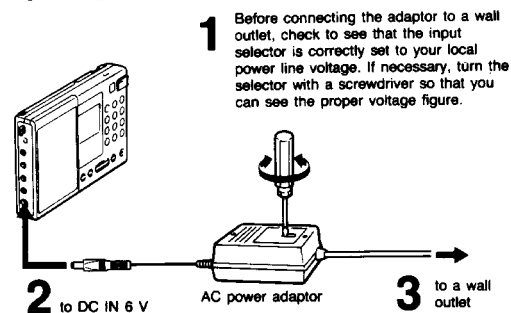

Notes

- Keep the batteries installed for the built-in computer back-up even if you use the external power sources. If you don't, the preset stations and current time will be erased.
- The internal batteries are automatically disconnected when the AC power adaptor or the car battery cord is connected to the DC IN 6 V jack.

For use on 12 V car battery, connect the Sony DCC-127A car battery cord (optional) to the DC IN 6 V jack.

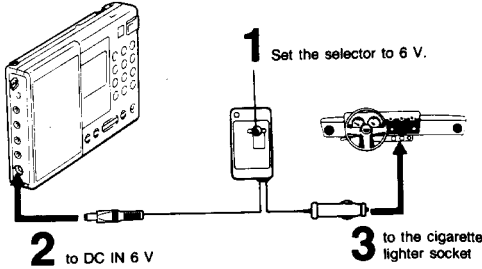

www.DataSheet4U.com

Note

Use only the recommended AC power adaptor or car battery cord manufactured by Sony. Polarity of the plugs of other manufacturers may be different.



Polarity of the Sony plug

How to Set the Clock

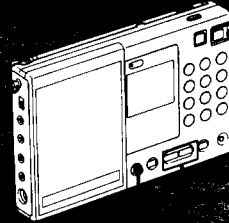

- 1 Set POWER/LOCK to POWER.
- 2 Press SET while keeping TIME pressed to adjust the clock to the current time. Each press on SET advances the time digit by one. To advance the time digits rapidly, keep SET pressed.



- 3 Release TIME. The clock will begin to operate.

Setting the clock while listening to the radio

You cannot set the clock while you are listening to the radio. Be sure to press ON/OFF to turn the radio off and set the clock.

The display when the radio is turned off

The current time is displayed.

Zero second adjustment

If you want to adjust the time exactly to the second with a telephone time signal, proceed as in the following example.

Example: To set to 15:15

- 1 Adjust the time indication to 15:15 and keep TIME pressed.
- 2 Release TIME simultaneously with the telephone time signal. The clock will then begin to show the precise time.

How to Change the MW Channel Step

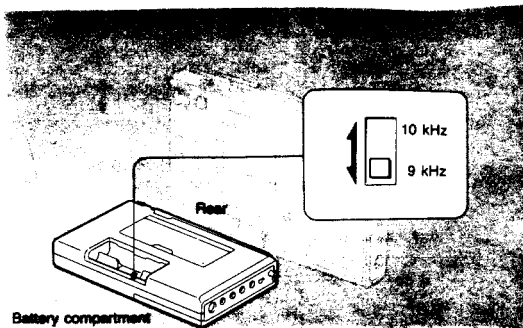

The frequency allocation of the area

Area	Frequency allocation system
North America, South America	10 kHz step
Other countries	9 kHz step

Notes

Change the MW CH STEP within 10 minutes

If more than 10 minutes have passed after batteries were removed, the current time will be erased. In this case, set the time again.

The preset stations will be erased

When you change the MW channel step, the preset stations will be erased. In such a case, preset the stations again.

The MW channel step is factory-set to 9 (10) kHz to match the frequency allocation system of the country. If you use the radio where the frequency allocation system is based on a 10 (9) kHz interval, set the MW CH STEP selector in the battery compartment to 10 (9) kHz.

- 1 Set POWER/LOCK to LOCK.
- 2 Open the battery compartment and take out the batteries.
- 3 Change MW CH STEP.
- 4 Install the batteries and close the battery compartment.
- 5 Set POWER/LOCK to POWER.

Direct Tuning — when you know the frequency

frequency of a desired station

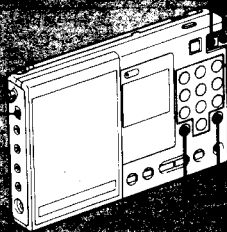

To improve receiving condition

MW/LW

FM

SW

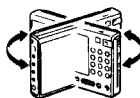

If you input a wrong frequency

Press **FM/EXECUTE** or **AM/EXECUTE** again and input the correct frequency.

If you do not press **FM** or **AM/EXECUTE** within 5 seconds after you input a frequency

The frequency indication turns to the previous one and you will hear the station of its frequency.

When the frequency near the input frequency is displayed

The frequencies which this radio receives are allocated in the following intervals depending on the broadcast band.

If you input a frequency that does not match these intervals, the frequency just below the one that you input will be tuned in and will be displayed.

FM	0.05 or 0.1 MHz	SW	5 kHz
MW	10 kHz*	LW	3 kHz

* Possible to change to 9 kHz depending on the country where used (see page 6).

If **TRY AGAIN!** indication appears

If you input the frequency outside the frequency range, **TRY AGAIN!** blinks. When you press **FM/EXECUTE** or **AM/EXECUTE** again, this indication will disappear. If you do not press the button, it will disappear after 5 seconds and the frequency of the previously tuned station will appear.

When the sound is distorted

Normally set **SENS** to **DX**, however, when the sound is distorted set it to **LOCAL**.

When you are listening to the news

Set **TONE** to **NEWS**. Human voice will be heard more clearly. When you are listening to music, set it to **MUSIC**.

- 1 Set **POWER/LOCK** to **POWER**.
- 2 Press **ON/OFF**.
The radio is turned on.
- 3 Press the desired band (**FM/EXECUTE** or **AM/EXECUTE**) button.
To receive **SW**, **MW**, **LW**, press **AM**.
- 4 Input the frequency of a desired station by pressing **PRESET/DIRECT TUNING**.
- 5 Press the same band button again within 5 seconds.
The station will be tuned in.
- 6 Adjust the volume.

eg. AM. 810 kHz



To turn off the radio, press **ON/OFF**.

Manual Tuning

— If you do not know the frequency of a desired station.

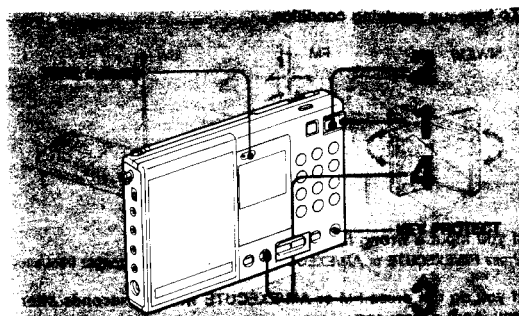

1 Set POWER/LOCK to POWER.

2 Press ON/OFF.

The radio is turned on.

3 Press MANUAL TUNING (+ or -) repeatedly while keeping BAND pressed to search for the approximate frequency of a desired station.

The lowest frequency of each band or the meter band of SW appears in the display.

If you keep MANUAL TUNING pressed, the band changes continuously.

4 Press MANUAL TUNING (+ or -) repeatedly to search for a desired station.

To prevent accidental change of the receiving station

Press KEY PROTECT. The  mark appears in the display window and all the buttons on the front panel will not work.

To release the KEY PROTECT function, press KEY PROTECT again.

When the station is tuned in

The TUNE indicator lights up.

Frequency band changes continuously

If you keep MANUAL TUNING (+) pressed, the frequency band being tuned in will change from LW to MW, SW, FM and then back to LW.

What is meter band?

SW is divided into 13 bands by the wave length (meter).

Each band is called meter band (see page .

Scan Tuning

— To have a station scanned automatically

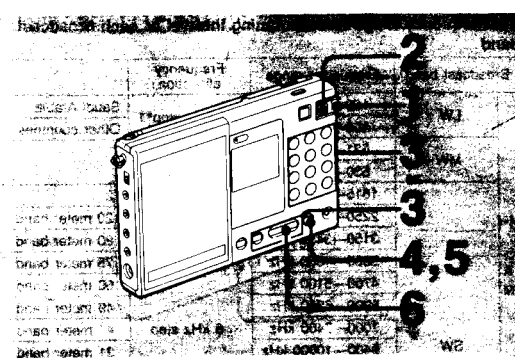

1 Set POWER/LOCK to POWER.

2 Press ON/OFF.

3 Receive a broadcast band by pressing MANUAL TUNING while keeping BAND pressed, or by pressing PRESET/DIRECT TUNING. (Refer to the table on the right page for the frequency range of each broadcast band.)

4 Press SCAN TUNING START/STOP.

Within the frequency range of the table on page , scan tuning will begin and stop automatically for 1.5 seconds when a station is received and then the tuning indicator lights up.

5 Press SCAN TUNING START/STOP again to listen to the station being received.

6 Tune in the station more precisely by MANUAL TUNING (+ or -), if necessary.

Scan Tuning

The frequency range and the tuning interval of each broadcast band

Broadcast band	Frequency range	Frequency allocation	
LW	150—285 kHz	3 kHz step*1	Saudi Arabia
	150—528 kHz		Other countries
MW	531—1611 kHz	9 kHz step	
	530—1610 kHz	10 kHz step	
AM	1615—2245 kHz	5 kHz step	*2
	2250—2550 kHz		120 meter band
	3150—3450 kHz		90 meter band
	3850—4050 kHz		75 meter band
	4700—5100 kHz		60 meter band
	5900—6250 kHz		49 meter band
	7000—7400 kHz		41 meter band
	9400—10000 kHz		31 meter band
	11500—12150 kHz		25 meter band
	13500—13900 kHz		21 meter band
	15000—15700 kHz		19 meter band
	17450—18000 kHz		16 meter band
	21400—21950 kHz		13 meter band
	25600—26100 kHz		11 meter band
FM	87.50—108.00 MHz	0.05 MHz step	*4
	76.00—108.00 MHz	0.1 MHz step	*5

*1 Some of the LW stations are not tuned in with the 3 kHz interval. When you try to tune in them, first tune in the frequency near them and then tune in precisely with FINE TUNING (see page 6).

*2 These frequencies can be tuned in either by direct tuning or manual tuning but cannot be selected by pressing both BAND and MANUAL TUNING.

*3 Except for Saudi Arabia

*4 France, Germany, Scandinavian countries and Saudi Arabia

*5 Countries other than *4

When scanning stops too often

Set SENS to LOCAL.

Preset Tuning — To preset the frequency of a desired station

How to Preset a Station

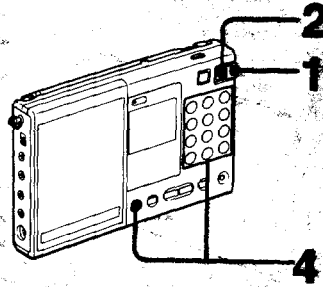

- 1 Set POWER/LOCK to POWER.
- 2 Press ON/OFF.
- 3 Tune in a desired station.
- 4 Press one of the PRESET/DIRECT TUNING buttons while keeping ENTER pressed. The desired station is stored on that button.

e.g. To preset FM 89.0 MHz on the button 1

Blinks while ENTER is pressed.

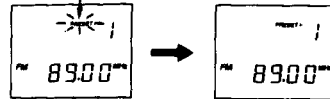

The number of the stations you can preset

Up to 10 FM and AM stations in total can be preset on the PRESET/DIRECT TUNING buttons. You can store only one station on each button.

To Tune in a Preset Station

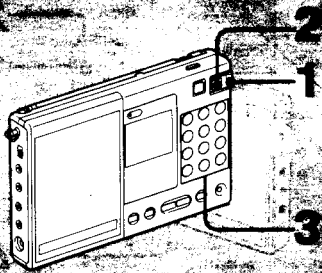

- 1 Set POWER/LOCK to POWER.
- 2 Press ON/OFF.
- 3 Press a desired PRESET/DIRECT TUNING button.
The preset station will be tuned in.

www.DataSheet4U.com

To check the preset station

Press PRESET/DIRECT TUNING while pressing BAND. The frequency of the preset station is displayed. You can check anytime even if another station is tuned in.

To change the preset station

Store a station on a desired PRESET/DIRECT TUNING button. The station previously stored on the button is erased.

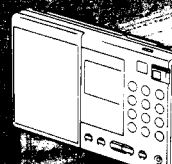
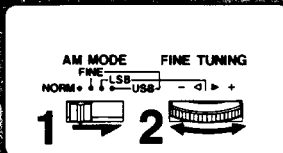

This radio receives the station at the interval of frequency shown in the list on pages ● and ●. To receive a station whose frequency does not coincide with this interval, it is necessary to adjust the tuning in approx. ± 5 kHz range by FINE TUNING. In this case, the frequency display will not change.

- 1 Set AM MODE to FINE.
- 2 Adjust the tuning with FINE TUNING.
+ : For a frequency up to approx. 5 kHz higher
- : For a frequency up to approx. 5 kHz lower

Note

FM band cannot be adjusted with FINE TUNING.

How to Tune in SSB Transmissions

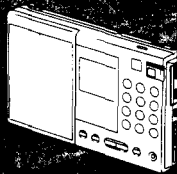
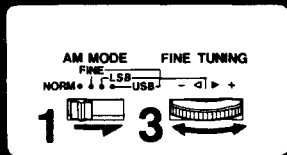

1 Set AM MODE to LSB or USB.

Position	Type of broadcast
NORM	When not using FINE TUNING or when not listening to SSB transmissions
FINE	When adjusting LW, MW, or SW band (DSB-Double Side Band) precisely with FINE TUNING
LSB ^{*1}	When tuning in ham and CW transmissions below 10 MHz
USB ^{*2}	When tuning in ham and business radio above 10 MHz

*1 Lower Side Band

*2 Upper Side Band

2 Tune in a frequency near the broadcast you want to listen to by using manual tuning (Page 10), direct tuning (Page 11), or preset tuning (Page 12).

3 Adjust the tuning with FINE TUNING.

SSB (Single Side Band)

SSB is very popular among ham and business radio and will be found on all of the amateur bands because of its signal intelligibility. This results from that it transmits signals with half bandwidth of DSB (Double Side Band).

Typical AM (MW, LW, SW) band uses DSB. In DSB transmission, the amplitude of a carrier is modulated according to transmitted frequencies as shown below.

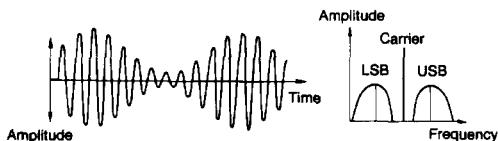

Audio signals are included both in USB and LSB. These signals included in USB and LSB are the same ones except that they are in the opposite phase relation.

This means that transmission can be done using only one of USB and LSB. SSB transmission is the system in which such a method is used. In general, SSB transmissions up to 10 MHz shall employ LSB modulation, and those above this frequency shall use USB. To receive SSB transmission, the unit with the BFO (Beat Frequency Oscillator) circuits is needed to convert SSB signals into audio signals. SSB cannot be heard with the radio which has no such circuits.

CW (Continuous Wave)

CW is also popular among ham and business radio. In CW transmission, the amplitude of a carrier is not modulated while that of other systems is modulated. CW conveys information by interrupting a carrier using Morse code. It can be heard as a beat sound only with the unit equipped with the BFO circuits. To understand information transmitted by CW, you need to learn the Morse code.

Having the Radio Turned on

Automatically—Timer standby function

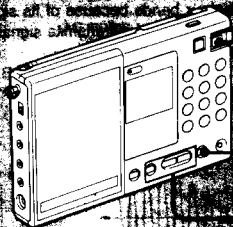

- 1 Tune in the station which you want to listen to at a desired time.
- 2 Adjust the volume.
- 3 Press ON/OFF to turn off the radio.



Note
After setting the timer, if you tune in another station and turn off the radio, the station tuned in last will be received when the timer turns the radio on.

Once you set the time
The radio is turned on at the same time everyday.

- 4 Set the time by pressing SET (+ or -) while keeping ALARM pressed.
If you keep SET pressed, the time will change continuously.

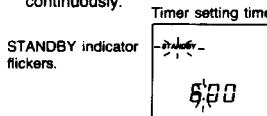

- 5 Release ALARM. The current time appears in the display.
- 6 Press STANDBY. The STANDBY indicator stops flickering.



When the radio is turned on at the preset time

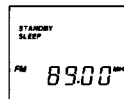

The radio will be turned off after about 65 minutes.

To cancel the standby mode
Press STANDBY.

To check the preset time
Press ALARM.

To change the preset time
Set the desired alarm time. The time previously set is erased.

When POWER/LOCK is set to LOCK
The timer standby function does not work.

How to Set the Sleep Timer

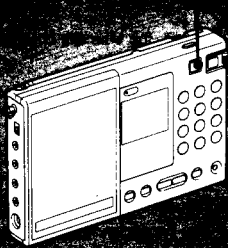

1 Set POWER/LOCK to POWER.

2 Press SLEEP.

The radio is turned on.

Current time

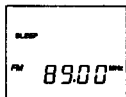

3 Tune in the desired station and adjust the volume.

The radio will be turned off automatically after about 65 minutes.

When you press SLEEP while listening to the radio

The radio will be turned off automatically after about 65 minutes.

To turn off the radio before the sleep time

Press ON/OFF.

How to have the radio turned off and turned on automatically

You can have the radio turned off and turned on automatically using both the sleep timer and timer standby function. First set the standby function (page ●), then press SLEEP.

How to Use the Supplied SW Compact Antenna — For better SW reception

Usually the telescopic antenna is sufficient for SW reception. However, in a metal or concrete building, the use of the supplied SW compact antenna is commended.

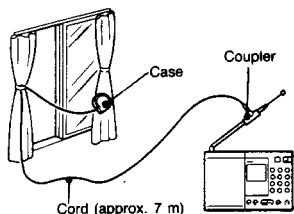

- 1 Fully pull out the cord from the case.
 - 2 Attach the coupler to the telescopic antenna.
 - 3 When the window can be opened:
 - Extend the cord and the case out through the window, after making sure there is no danger.
- When the window cannot be opened:
Fully extend the cord along the frame of the window.

After using



How to Use an Optional Antenna

Using the Supplied Antenna Connector

Connect an optional coaxial cable to the supplied antenna connector. Connect the antenna connector to the EXT ANT jack of the ICF-SW7600.

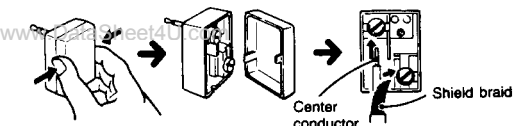

For FM Reception

In a steel-frame building, a mountainous area, at a distance from the transmitter or in a location where ignition noise is severe, FM reception may be unsatisfactory with the telescopic antenna. In this case, connect a commercially available external FM antenna with a 75-ohm coaxial cable.

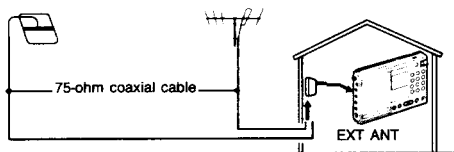

na

For All Weather Reception
 AN-1 or AN-102 with range extension is used

Method A

With a connecting cord, connect the OUTPUT jack of the antenna controller (supplied with the AN-1 or the AN-102) and the EXT ANT jack of the ICF-SW7600.

Method B (for LW/MW reception only)

- 1 With a connecting cord, connect the OUTPUT jack of the antenna controller and the INPUT jack of the antenna coupler (supplied with the AN-1 or AN-102).
- 2 Put the antenna coupler near the ICF-SW7600.

Example: When the AN-1 is used.

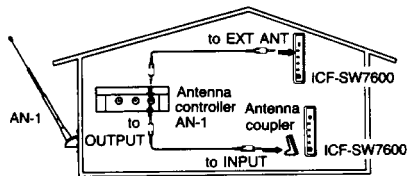

Notes

- When receiving MW or LW broadcasts without an external antenna, be sure to disconnect a SW external antenna. Otherwise, you cannot receive them as the built-in ferrite bar antenna does not function.
- If there is lightning, do not touch the wire of an external antenna and disconnect its AC power adaptor (if connected) immediately.
- When using an external antenna, retract the telescopic antenna.
- Locate an outdoor antenna as far away from the street as possible.
- For details about an external antenna, refer to its instruction manual.

Recording Radio Programs

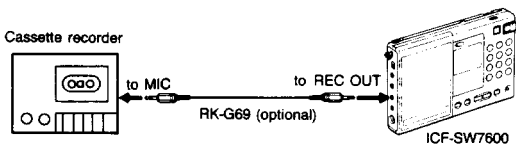

Recording at a Desired Time

You can start recording programs at the desired time by connecting the radio to the Sony TCM-27 cassette-corder.

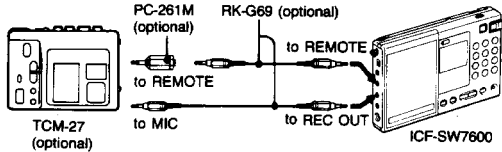

- 1 Tune in a desired station.
 - 2 Set the standby function (page 6).
 - 3 Connect the radio to the cassette-corder as shown above.
 - 4 Set the standby function of the cassette-corder.
- For details, see the operating instructions of the cassette-corder.

Notes on recording with the timer

- You cannot start recording at a desired time if you use the cassette-corder not equipped with the timer standby switch.
- When you use the Sony TCM-25, the optional RM-43 synchronizing recording unit is required.

Specifications

Circuit system

FM: Superheterodyne

AM: Dual conversion superheterodyne

Frequency range

FM*	France, Germany, Scandinavian countries and Saudi Arabia	87.5 - 108 MHz
	Other countries	76 - 108 MHz
LW	Saudi Arabia	150 - 285 kHz
	Other countries	150 - 528 kHz
MW	With the MW CH STEP selector at 9 kHz	531 - 1611 kHz
	With the MW CH STEP selector at 10 kHz	530 - 1610 kHz
SW	Saudi Arabia	1615 - 26100 kHz
	Other countries	1615 - 29995 kHz

*Stereo reception when using stereo earphones

Antennas

Telescopic antenna (FM/SW)

Built-in ferrite bar antenna (MW/LW)

Speaker

Approx. 77 mm (3 1/8 inches) dia. 8 ohms

Power output

400 mW (at 10% harmonic distortion)

Recording output jack (minijack)

output level 0.775 mV (-80 dB)

output impedance 1 kilohm

Headphone jack (stereo minijack) for 16 ohm stereo earphones

Power requirements

6 V DC

Four size AA (R6) batteries

Supplied AC power adaptor

For the U.S.A. model: 120 V AC, 50/60 Hz

For the Canadian model: 110, 120, 220, or 240 V AC adjustable, 50/60 Hz

Optional DCC-127A car battery cord for use with 12 V car battery

Optional DCC-240 car battery cord for use with 24 V car battery

Battery life

Approx. 10 hours of listening for four hours a day at a normal volume, using Sony SUM-3 (NS) batteries

Dimensions

Approx. 191.2 x 118 x 32.3 mm (w/h/d)

(7 5/8 x 4 9/16 x 1 5/16 inches)

including projecting parts and controls

Weight

Approx. 615 g (1 lb. 5.7 oz.) including batteries

Accessories supplied

Stereo earphones (1), Ear adaptor (2), AC power adaptor (1), Compact antenna (1), Antenna connector (1), Carrying case (1), Wave handbook (1)

Design and specifications subject to change without notice.

Optional accessories

Car battery cord DCC-127A, DCC-240

Connecting cord RK-G69 (miniplug to miniplug, no resistor type)

Plug adaptor PC-261M

Cassette-corder TCM-27

LW/MW/SW wide range antenna AN-1, AN-102

Troubleshooting Guide

The power is not turned on even if you press the ON/OFF button.

- Weak batteries.
- Incorrect polarity of batteries. See page 10.
- The POWER/LOCK switch is set to LOCK.
- The AC power adaptor or a car battery cord is not connected on AC operation.
- Battery operation is attempted while an AC power adaptor or a car battery cord is connected to the unit, but not to a wall outlet or cigarette lighter socket.

No display in the time display

- Incorrect polarity of batteries. See page 10.
- Weak batteries.

Display is dim.

- Weak batteries.
⇒ Replace all batteries with new ones for the frequency display or the time display.
- The unit is being used in extremely high temperatures or in a place will excessive moisture.

Sound is not heard at all.

- The VOLUME control is turned down completely.
- The stereo earphones are plugged in.
- Incorrect polarity of batteries. See page 10.

Very weak or interrupted sound, or unsatisfactory reception.

- Weak batteries.
- Tuning or antenna adjustment is not correct.
⇒ Tune in correctly with manual tuning. See page 10. For antenna adjustment, see page 10.
- Weak signal. ⇒ When in a vehicle or in a building, listen near a window.
- Figures on the frequency display differ a little from the acted station frequency. ⇒ Tune more precisely with the FINE TUNING control. See page 10.
- The SENS selector is set to LOCAL ⇒ Set to DX.
- The AM MODE selector is set to FINE, LSB or USB. ⇒ Set to NORM.

Frequency cannot be input during direct tuning.

FM or AM/EXECUTE was not pressed within 5 seconds after the preset keys have been pressed.

Stations have not been stored.

You made wrong operation when you store stations. ⇒ To store stations, press one of the PRESET/DIRECT TUNING buttons while holding down the ENTER button.

No key input is acceptable.

The KEY PROTECT button has been pressed. ⇒ Press this button again to make  mark disappear.

The preset station cannot be received during preset tuning.

- Incorrect PRESET/DIRECT TUNING button has been preset.
- The preset station was erased. ⇒ After replacing the batteries, store the station again.

The radio is not turned on at the timer-setting time.

- The STANDBY button has not been pressed.
- When it took more than 10 minutes to replace batteries, the timer setting-time was erased.
⇒ After replacing the batteries, set the timer again.
- The POWER/LOCK switch is set to LOCK.