

ICL8007

ICL8007 JFET Input Operational Amplifier



GENERAL DESCRIPTION

The Intersil ICL8007 is a low input current JFET input operational amplifier. The ICL8007A is selected for 4 pA max input current.

The devices are designed for use in very high input impedance applications. Because of their high slew rate, high common mode voltage range and absence of "latch-up", they are ideal for use as a voltage follower.

The Intersil 8007 and 8007A are short circuit protected. They require no external components for frequency compensation because the internal 6 dB/roll-off insures stability in closed loop applications. A unique bootstrap circuit insures unusually good common mode rejection for a JFET input op-amp and prevents large input currents as seen in some amplifiers at high common mode voltage.

FEATURES

- Ultra Low Input Current
- High Slew Rate — 6V/μs
- Wide Input Common Mode Voltage
- 1MHz Band Width
- Excellent Stability
- Ideal for Unity Gain Applications

ORDERING INFORMATION

Part Number	Temperature Range	Package
ICL8007CTY ICL8007ACTV	0°C to +70°C	8 LEAD TO-99 METAL CAN
ICL8007MTY ICL8007AMTV	-55°C to +125°C	

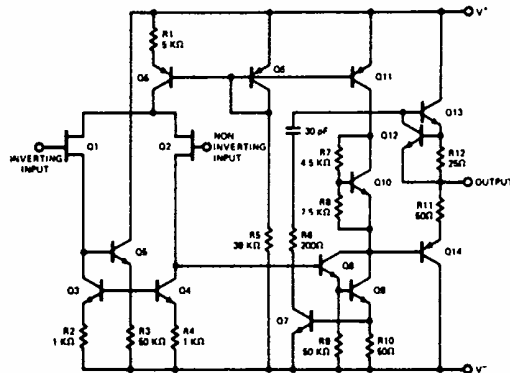
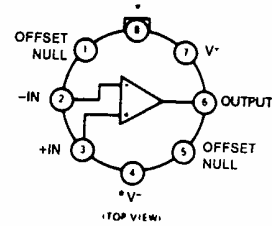

Figure 1: Functional Diagram

0310-1



0310-2

ICL8007 pin 4 connected to case (TY package)
ICL8007A pin 8 connected to case (TV package)
Figure 2: Pin Configuration

ICL8007



ICL8007

T-79-15

ABSOLUTE MAXIMUM RATINGS

Supply Voltage	± 18V
Power Dissipation (Note 1)	500mW
Differential Input Voltage	± 30V
Input Voltage (Note 2)	± 15V
Storage Temperature Range	-65°C to +150°C

Operating Temperature Range	
8007M, 8007AM	-55°C to +125°C
8007C, 8007AC	0°C to +70°C
Lead Temperature (Soldering, 10sec)	300°C
Output Short-Circuit Duration (Note 3)	Indefinite

NOTES:

1. Rating applies for case temperatures to 125°C; derate linearly at 6.5 mW/°C for ambient temperatures above +75°C.
2. For supply voltages less than ± 15V, the absolute maximum input voltage is equal to the supply voltage.
3. Short circuit may be to ground or either supply. Rating applies to +125°C case temperature or +75°C ambient temperature.
4. For Design only, not 100% tested.

NOTE: Stresses above those listed under "Absolute Maximum Ratings" may cause permanent damage to the device. These are stress ratings only and functional operation of the device at these or any other conditions above those indicated in the operational sections of the specifications is not implied. Exposure to absolute maximum rating conditions for extended periods may affect device reliability.

ELECTRICAL CHARACTERISTICS (V_S = ± 15V unless otherwise specified)

Characteristics	Test Conditions	8007M			8007C			8007AM & 8007AC			Units
		Min	Typ	Max	Min	Typ	Max	Min	Typ	Max	
The following specifications apply for T_A = 25°C:											
Input Offset Voltage	R _S ≤ 100kΩ		10	20		20	50		15	30	mV
Input Offset Current			0.5			0.5			0.2		pA
Input Bias Current (either input)			2.0	20		3.0	50		0.5	4.0	pA
Input Resistance			10 ⁶			10 ⁶			10 ⁶		MΩ
Input Capacitance			2.0			2.0			2.0		pF
Large Signal Voltage Gain	R _L ≥ 2kΩ, V _{OUT} = ± 10V	50,000			20,000			20,000			V/V
Output Resistance			75			75			75		Ω
Output Short-Circuit Current			25			25			25		mA
Supply Current			3.4	5.2		3.4	6.0		3.4	6.0	mA
Power Consumption			102	156		102	180		102	180	mW
Slew Rate			6.0			6.0		2.5	6.0		V/μs
Unity Gain Bandwidth			1.0			1.0			1.0		MHz
Risetime	C _L ≤ 100pF, R _L = 2kΩ		300			300			300		ns
Overshoot	C _L ≤ 100pF, R _L = 2kΩ		10			10			10		%
The following specifications apply for 0°C ≤ T_A ≤ +70°C (8007C and 8007AC), and -55°C ≤ T_A ≤ +125°C (8007M and 8007AM):											
Input Voltage Range			± 10	± 12		± 10	± 12		± 10	± 12	V
Common Mode Rejection Ratio			70	90		70	90		86	95	dB
Supply Voltage Rejection Ratio			70	300		70	600		70	200	μV/V
Large Signal Voltage Gain			25,000			15,000			15,000		V/V
Output Voltage Swing	R _L ≥ 10kΩ		± 12	± 14		± 12	± 14		± 12	± 14	V
	R _L ≥ 2kΩ		± 10	± 13		± 10	± 13		± 10	± 13	V
Input Bias Current (either input)	T _A = +125°C			2.0					1.0		nA
	T _A = +70°C					50			30		pA
Average Temperature Coefficient of Input Offset Voltage	(Note 4)			75			75			50	μV/°C

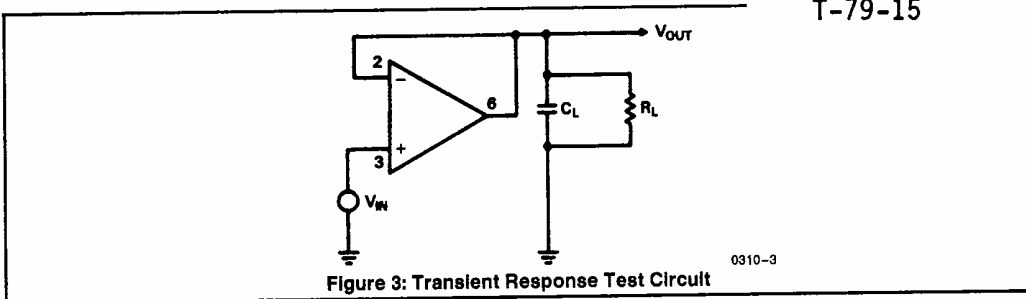
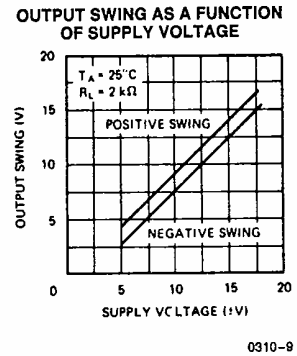
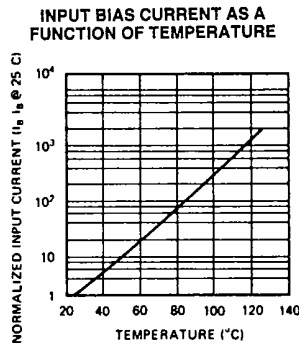
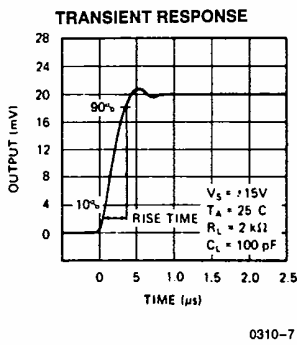
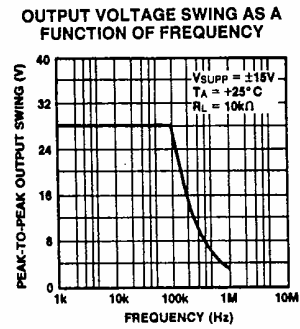
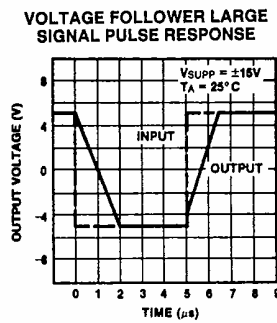
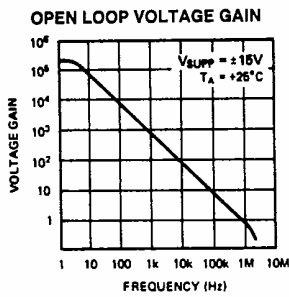

Figure 3: Transient Response Test Circuit

TYPICAL PERFORMANCE CHARACTERISTICS



ICL8007



ICL8007

T-79-15

TYPICAL PERFORMANCE CHARACTERISTICS (Continued)

OPEN LOOP VOLTAGE GAIN AS A FUNCTION OF SUPPLY VOLTAGE

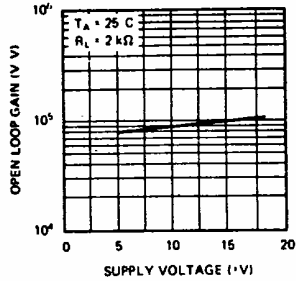

0310-10

INPUT VOLTAGE RANGE AS A FUNCTION OF SUPPLY VOLTAGE

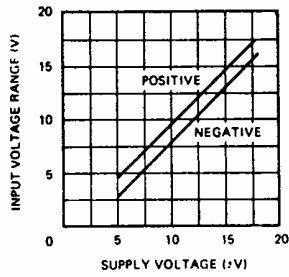

0310-11

QUIESCENT SUPPLY CURRENT AS A FUNCTION OF SUPPLY VOLTAGE

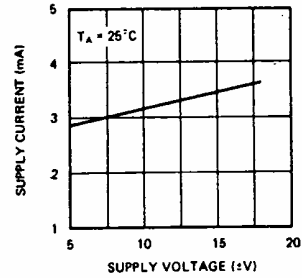

0310-12

QUIESCENT SUPPLY CURRENT AS A FUNCTION OF TEMPERATURE

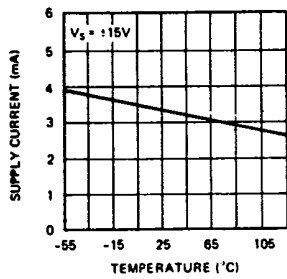

0310-13

INPUT VOLTAGE NOISE AS A FUNCTION OF FREQUENCY

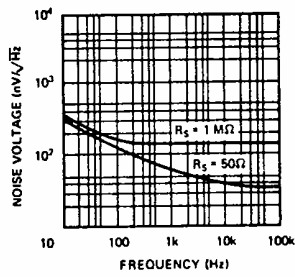

0310-14

WIDEBAND NOISE AS A FUNCTION OF SOURCE RESISTANCE

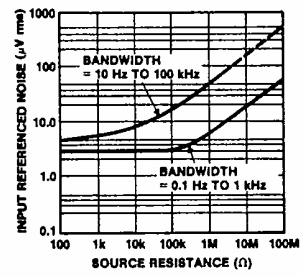

0310-15

For additional information, see Application Note A005.