



**GENERAL DESCRIPTION**



The ICS83054I-01 is a 4-bit, 2:1, Single-ended Multiplexer and a member of the HiPerClockS™ family of High Performance Clock Solutions from ICS. The ICS83054I-01 has two selectable single-ended clock inputs and four single-ended clock outputs.

The output has a  $V_{DDO}$  pin which may be set at 3.3V, 2.5V, or 1.8V, making the device ideal for use in voltage translation applications. An output enable pin places the output in a high impedance state which may be useful for testing or debug. Possible applications include systems with up to four transceivers which need to be independently set for different rates. For example, a board may have four transceivers, each of which need to be independently configured for 1 Gigabit Ethernet or 1 Gigabit Fibre Channel rates. Another possible application may require the ports to be independently set for FEC (Forward Error Correction) or non-FEC rates. The device operates up to 250MHz and is packaged in a 16 TSSOP.

**FEATURES**

- 4-bit, 2:1 single-ended multiplexer
- Nominal output impedance:  $15\Omega$  ( $V_{DDO} = 3.3V$ )
- Maximum output frequency: 250MHz
- Propagation delay: 2.5ns (typical)
- Input skew: 45ps (typical)
- Part-to-part skew: TBD
- Additive phase jitter, RMS (12KHz - 20MHz): 0.07ps (typical)
- Operating supply modes:  
 $V_{DD}/V_{DDO}$   
 3.3V/3.3V  
 3.3V/2.5V  
 3.3V/1.8V  
 2.5V/2.5V  
 2.5V/1.8V
- -40°C to 85°C ambient operating temperature

**BLOCK DIAGRAM**

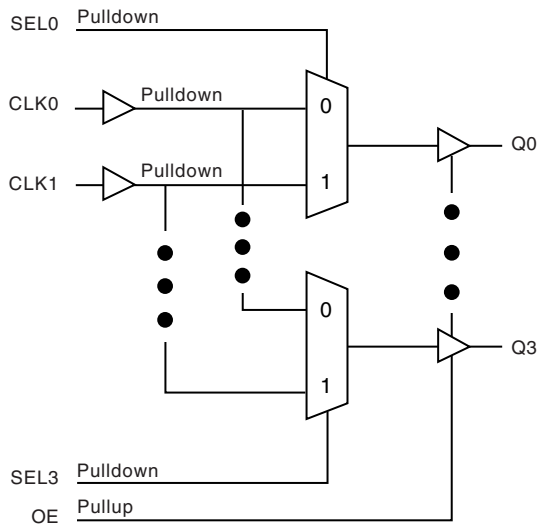

**PIN ASSIGNMENT**

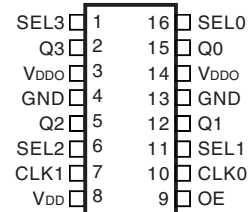

**ICS83054I-01**  
**16-Lead TSSOP**  
 4.4mm x 3.0mm x 0.92mm package body  
**G Package**  
 Top View

The Preliminary Information presented herein represents a product in prototyping or pre-production. The noted characteristics are based on initial product characterization. Integrated Circuit Systems, Incorporated (ICS) reserves the right to change any circuitry or specifications without notice.



**TABLE 1. PIN DESCRIPTIONS**

Number	Name	Type		Description
1, 6 11, 16	SEL3, SEL2, SEL1, SEL0	Input	Pulldown	Clock select inputs. See Control Input Function Table. LVCMOS / LVTTTL interface levels.
2, 5, 9, 12, 15	Q3, Q2, Q1, Q0	Output		Single-ended clock output. LVCMOS/LVTTTL interface levels.
3, 14	V <sub>DDO</sub>	Power		Output supply pins.
4, 13	GND	Power		Power supply ground.
7, 10	CLK1, CLK0	Input	Pulldown	Single-ended clock inputs. LVCMOS/LVTTTL interface levels.
8	V <sub>DD</sub>	Power		Core supply pin.
9	OE	Input	Pullup	Output enable. When LOW, outputs are in HIGH impedance state. When HIGH, outputs are active. LVCMOS / LVTTTL interface levels.

NOTE: *Pullup* and *Pulldown* refer to internal input resistors. See Table 2, Pin Characteristics, for typical values.

**TABLE 2. PIN CHARACTERISTICS**

Symbol	Parameter	Test Conditions	Minimum	Typical	Maximum	Units
C <sub>IN</sub>	Input Capacitance			4		pF
R <sub>PULLUP</sub>	Input Pullup Resistor			51		KΩ
R <sub>PULLDOWN</sub>	Input Pulldown Resistor			51		KΩ
C <sub>PD</sub>	Power Dissipation Capacitance (per output)			11		pF
R <sub>OUT</sub>	Output Impedance			15		Ω

**TABLE 3. CONTROL INPUT FUNCTION TABLE**

Control Inputs				Outputs			
SEL3	SEL2	SEL1	SEL0	Q3	Q2	Q1	Q0
0	0	0	0	CLK0	CLK0	CLK0	CLK0
0	0	0	1	CLK0	CLK0	CLK0	CLK1
0	0	1	0	CLK0	CLK0	CLK1	CLK0
		•				•	
		•				•	
		•				•	
1	1	0	1	CLK1	CLK1	CLK0	CLK1
1	1	1	0	CLK1	CLK1	CLK1	CLK0
1	1	1	1	CLK1	CLK1	CLK1	CLK1



**ABSOLUTE MAXIMUM RATINGS**

Supply Voltage, $V_{DD}$	4.6V
Inputs, $V_I$	-0.5V to $V_{DD} + 0.5 V$
Outputs, $V_O$	-0.5V to $V_{DDO} + 0.5V$
Package Thermal Impedance, $\theta_{JA}$	89°C/W (0 lfpm)
Storage Temperature, $T_{STG}$	-65°C to 150°C

NOTE: Stresses beyond those listed under Absolute Maximum Ratings may cause permanent damage to the device. These ratings are stress specifications only. Functional operation of product at these conditions or any conditions beyond those listed in the *DC Characteristics* or *AC Characteristics* is not implied. Exposure to absolute maximum rating conditions for extended periods may affect product reliability.

www.DataSheet4U.com

**TABLE 4A. POWER SUPPLY DC CHARACTERISTICS,  $V_{DD} = 3.3V \pm 5\%$ ,  $V_{DDO} = 3.3V \pm 5\%$ , OR  $2.5V \pm 5\%$ , OR  $1.8V \pm 0.2V$ ,  $T_A = -40^\circ C$  TO  $85^\circ C$**

Symbol	Parameter	Test Conditions	Minimum	Typical	Maximum	Units
$V_{DD}$	Core Supply Voltage		3.135	3.3	3.465	V
$V_{DDO}$	Output Supply Voltage		3.135	3.3	3.465	V
			2.375	2.5	2.625	V
			1.6	1.8	2.0	V
$I_{DD}$	Power Supply Current		32		mA	
$I_{DDO}$	Output Supply Current			4		mA

**TABLE 4B. POWER SUPPLY DC CHARACTERISTICS,  $V_{DD} = 2.5V \pm 5\%$ ,  $V_{DDO} = 2.5V \pm 5\%$ , OR  $1.8V \pm 0.2V$ ,  $T_A = -40^\circ C$  TO  $85^\circ C$**

Symbol	Parameter	Test Conditions	Minimum	Typical	Maximum	Units
$V_{DD}$	Core Supply Voltage		2.375	2.5	2.625	V
$V_{DDO}$	Output Supply Voltage		2.375	2.5	2.625	V
			1.6	1.8	2.0	V
$I_{DD}$	Power Supply Current		30		mA	
$I_{DDO}$	Output Supply Current			4		mA



**TABLE 4C. LVCMOS/LVTTL DC CHARACTERISTICS,  $T_A = -40^{\circ}\text{C}$  TO  $85^{\circ}\text{C}$**

Symbol	Parameter	Test Conditions	Minimum	Typical	Maximum	Units	
$V_{IH}$	Input High Voltage	CLK0, CLK1	$V_{DD} = 3.3\text{V} \pm 5\%$	2		$V_{DD} + 0.3$	V
			$V_{DD} = 2.5\text{V} \pm 5\%$	1.7		$V_{DD} + 0.3$	V
		OE, SELO:SEL3	$V_{DD} = 3.3\text{V} \pm 5\%$	2		$V_{DD} + 0.3$	V
			$V_{DD} = 2.5\text{V} \pm 5\%$	1.7		$V_{DD} + 0.3$	V
$V_{IL}$	Input Low Voltage	CLK0, CLK1	$V_{DD} = 3.3\text{V} \pm 5\%$	-0.3		1.3	V
			$V_{DD} = 2.5\text{V} \pm 5\%$	-0.3		0.7	V
		OE, SELO:SEL3	$V_{DD} = 3.3\text{V} \pm 5\%$	-0.3		1.3	V
			$V_{DD} = 2.5\text{V} \pm 5\%$	-0.3		0.7	V
$I_{IH}$	Input High Current	CLK0, CLK1, SELO:SEL3	$V_{DD} = 3.3\text{V}$ or $2.5\text{V} \pm 5\%$		150	$\mu\text{A}$	
		OE	$V_{DD} = 3.3\text{V}$ or $2.5\text{V} \pm 5\%$		5	$\mu\text{A}$	
$I_{IL}$	Input Low Current	CLK0, CLK1, SELO:SEL3	$V_{DD} = 3.3\text{V}$ or $2.5\text{V} \pm 5\%$	-5		$\mu\text{A}$	
		OE	$V_{DD} = 3.3\text{V}$ or $2.5\text{V} \pm 5\%$	-150		$\mu\text{A}$	
$V_{OH}$	Output High Voltage	$V_{DDO} = 3.3\text{V} \pm 5\%$ ; NOTE 1	2.6			V	
		$V_{DDO} = 2.5\text{V} \pm 5\%$ ; NOTE 1	1.8			V	
		$V_{DDO} = 1.8\text{V} \pm 0.2\text{V}$ ; NOTE 1	$V_{DD} - 0.3$			V	
$V_{OL}$	Output Low Voltage	$V_{DDO} = 3.3\text{V} \pm 5\%$ ; NOTE 1			0.5	V	
		$V_{DDO} = 2.5\text{V} \pm 5\%$ ; NOTE 1			0.45	V	
		$V_{DDO} = 1.8\text{V} \pm 0.2\text{V}$ ; NOTE 1			0.35	V	

NOTE 1: Outputs terminated with  $50\Omega$  to  $V_{DDO}/2$ . See Parameter Measurement section, "Load Test Circuit" diagrams.

**TABLE 5A. AC CHARACTERISTICS,  $V_{DD} = V_{DDO} = 3.3\text{V} \pm 5\%$ ,  $T_A = -40^{\circ}\text{C}$  TO  $85^{\circ}\text{C}$**

Symbol	Parameter	Test Conditions	Minimum	Typical	Maximum	Units
$f_{MAX}$	Output Frequency				250	MHz
$tp_{LH}$	Propagation Delay, Low to High; NOTE 1			2.5		ns
$tp_{HL}$	Propagation Delay, High to Low; NOTE 1			2.65		ns
$t_{sk}(i)$	Input Skew; NOTE 5			45		ps
$t_{sk}(pp)$	Part-to-Part Skew; NOTE 2, 5			TBD		ps
$t_{jit}$	Buffer Additive Phase Jitter, RMS; refer to Additive Phase Jitter section, NOTE 4	Integration Range: 12KHz - 20MHz		0.07		ps
$t_R / t_F$	Output Rise/Fall Time	20% to 80%		535		ps
odc	Output Duty Cycle			50		%
$t_{EN}$	Output Enable Time; NOTE 3				5	ns
$t_{DIS}$	Output Disable Time; NOTE 3				5	ns
$MUX_{ISOL}$	MUX Isolation	@ 100MHz		45		dB

NOTE 1A: Measured from  $V_{DD}/2$  of the input to  $V_{DDO}/2$  of the output.

NOTE 2: Defined as skew between outputs on different devices operating at the same supply voltages and with equal load conditions. Using the same type of input on each device, the output is measured at  $V_{DDO}/2$ .

NOTE 3: These parameters are guaranteed by characterization. Not tested in production.

NOTE 4: Driving only one input clock.

NOTE 5: This parameter is defined in accordance with JEDEC Standard 65.



**TABLE 5B. AC CHARACTERISTICS,  $V_{DD} = 3.3V \pm 5\%$ ,  $V_{DDO} = 2.5V \pm 5\%$ ,  $T_A = -40^\circ C$  TO  $85^\circ C$**

Symbol	Parameter	Test Conditions	Minimum	Typical	Maximum	Units
$f_{MAX}$	Output Frequency				250	MHz
$tp_{LH}$	Propagation Delay, Low to High; NOTE 1			2.7		ns
$tp_{HL}$	Propagation Delay, High to Low; NOTE 1			2.7		ns
$tsk(i)$	Input Skew; NOTE 5			38		ps
$tsk(pp)$	Part-to-Part Skew; NOTE 2, 5			TBD		ps
$f_{jit}$	Buffer Additive Phase Jitter, RMS; refer to Additive Phase Jitter section, NOTE 4	Integration Range: 12KHz - 20MHz		0.04		ps
$t_R / t_F$	Output Rise/Fall Time	20% to 80%		550		ps
odc	Output Duty Cycle			50		%
$t_{EN}$	Output Enable Time; NOTE 3				5	ns
$t_{DIS}$	Output Disable Time; NOTE 3				5	ns
$MUX_{ISOL}$	MUX Isolation	@100MHz		45		dB

NOTE 1A: Measured from  $V_{DD}/2$  of the input to  $V_{DDO}/2$  of the output.

NOTE 2: Defined as skew between outputs on different devices operating at the same supply voltages and with equal load conditions. Using the same type of input on each device, the output is measured at  $V_{DDO}/2$ .

NOTE 3: These parameters are guaranteed by characterization. Not tested in production.

NOTE 4: Driving only one input clock.

NOTE 5: This parameter is defined in accordance with JEDEC Standard 65.

**TABLE 5C. AC CHARACTERISTICS,  $V_{DD} = 3.3V \pm 5\%$ ,  $V_{DDO} = 1.8V \pm 0.2V$ ,  $T_A = -40^\circ C$  TO  $85^\circ C$**

Symbol	Parameter	Test Conditions	Minimum	Typical	Maximum	Units
$f_{MAX}$	Output Frequency				250	MHz
$tp_{LH}$	Propagation Delay, Low to High; NOTE 1			3		ns
$tp_{HL}$	Propagation Delay, High to Low; NOTE 1			3		ns
$tsk(i)$	Input Skew; NOTE 5			38		ps
$tsk(pp)$	Part-to-Part Skew; NOTE 2, 5			TBD		ps
$f_{jit}$	Buffer Additive Phase Jitter, RMS; refer to Additive Phase Jitter section, NOTE 4	Integration Range: 12KHz - 20MHz		0.05		ps
$t_R / t_F$	Output Rise/Fall Time	20% to 80%		595		ps
odc	Output Duty Cycle			50		%
$t_{EN}$	Output Enable Time; NOTE 3				5	ns
$t_{DIS}$	Output Disable Time; NOTE 3				5	ns
$MUX_{ISOL}$	MUX Isolation	@100MHz		45		dB

NOTE 1A: Measured from  $V_{DD}/2$  of the input to  $V_{DDO}/2$  of the output.

NOTE 2: Defined as skew between outputs on different devices operating at the same supply voltages and with equal load conditions. Using the same type of input on each device, the output is measured at  $V_{DDO}/2$ .

NOTE 3: These parameters are guaranteed by characterization. Not tested in production.

NOTE 4: Driving only one input clock.

NOTE 5: This parameter is defined in accordance with JEDEC Standard 65.



**TABLE 5D. AC CHARACTERISTICS,  $V_{DD} = V_{DDO} = 2.5V \pm 5\%$ ,  $T_A = -40^\circ C$  TO  $85^\circ C$**

Symbol	Parameter	Test Conditions	Minimum	Typical	Maximum	Units
$f_{MAX}$	Output Frequency				250	MHz
$tp_{LH}$	Propagation Delay, Low to High; NOTE 1			2.7		ns
$tp_{HL}$	Propagation Delay, High to Low; NOTE 1			2.9		ns
$t_{sk(i)}$	Input Skew; NOTE 5			45		ps
$t_{sk(pp)}$	Part-to-Part Skew; NOTE 2, 5			TBD		ps
$f_{jit}$	Buffer Additive Phase Jitter, RMS; refer to Additive Phase Jitter section, NOTE 4	Integration Range: 12KHz - 20MHz		0.10		ps
$t_R / t_F$	Output Rise/Fall Time	20% to 80%		540		ps
odc	Output Duty Cycle			50		%
$t_{EN}$	Output Enable Time; NOTE 3				5	ns
$t_{DIS}$	Output Disable Time; NOTE 3				5	ns
$MUX_{ISOL}$	MUX Isolation	@100MHz		45		dB

NOTE 1A: Measured from  $V_{DD}/2$  of the input to  $V_{DDO}/2$  of the output.

NOTE 2: Defined as skew between outputs on different devices operating a the same supply voltages and with equal load conditions. Using the same type of input on each device, the output is measured at  $V_{DDO}/2$ .

NOTE 3: These parameters are guaranteed by characterization. Not tested in production.

NOTE 4: Driving only one input clock.

NOTE 5: This parameter is defined in accordance with JEDEC Standard 65.

**TABLE 5E. AC CHARACTERISTICS,  $V_{DD} = 2.5V \pm 5\%$ ,  $V_{DDO} = 1.8V \pm -0.2V$ ,  $T_A = -40^\circ C$  TO  $85^\circ C$**

Symbol	Parameter	Test Conditions	Minimum	Typical	Maximum	Units
$f_{MAX}$	Output Frequency				250	MHz
$tp_{LH}$	Propagation Delay, Low to High; NOTE 1			2.9		ns
$tp_{HL}$	Propagation Delay, High to Low; NOTE 1			3		ns
$t_{sk(i)}$	Input Skew; NOTE 5			43		ps
$t_{sk(pp)}$	Part-to-Part Skew; NOTE 2, 5			TBD		ps
$f_{jit}$	Buffer Additive Phase Jitter, RMS; refer to Additive Phase Jitter section, NOTE 4	Integration Range: 12KHz - 20MHz		0.07		ps
$t_R / t_F$	Output Rise/Fall Time	20% to 80%		590		ps
odc	Output Duty Cycle			50		%
$t_{EN}$	Output Enable Time; NOTE 3				5	ns
$t_{DIS}$	Output Disable Time; NOTE 3				5	ns
$MUX_{ISOL}$	MUX Isolation	@100MHz		45		dB

NOTE 1A: Measured from  $V_{DD}/2$  of the input to  $V_{DDO}/2$  of the output.

NOTE 2: Defined as skew between outputs on different devices operating a the same supply voltages and with equal load conditions. Using the same type of input on each device, the output is measured at  $V_{DDO}/2$ .

NOTE 3: These parameters are guaranteed by characterization. Not tested in production.

NOTE 4: Driving only one input clock.

NOTE 5: This parameter is defined in accordance with JEDEC Standard 65.



ADDITIVE PHASE JITTER

The spectral purity in a band at a specific offset from the fundamental compared to the power of the fundamental is called the **dBc Phase Noise**. This value is normally expressed using a Phase noise plot and is most often the specified plot in many applications. Phase noise is defined as the ratio of the noise power present in a 1Hz band at a specified offset from the fundamental frequency to the power value of the fundamental. This ratio is expressed in decibels (dBm) or a ratio of the power in

the 1Hz band to the power in the fundamental. When the required offset is specified, the phase noise is called a **dBc** value, which simply means dBm at a specified offset from the fundamental. By investigating jitter in the frequency domain, we get a better understanding of its effects on the desired application over the entire time record of the signal. It is mathematically possible to calculate an expected bit error rate given a phase noise plot.

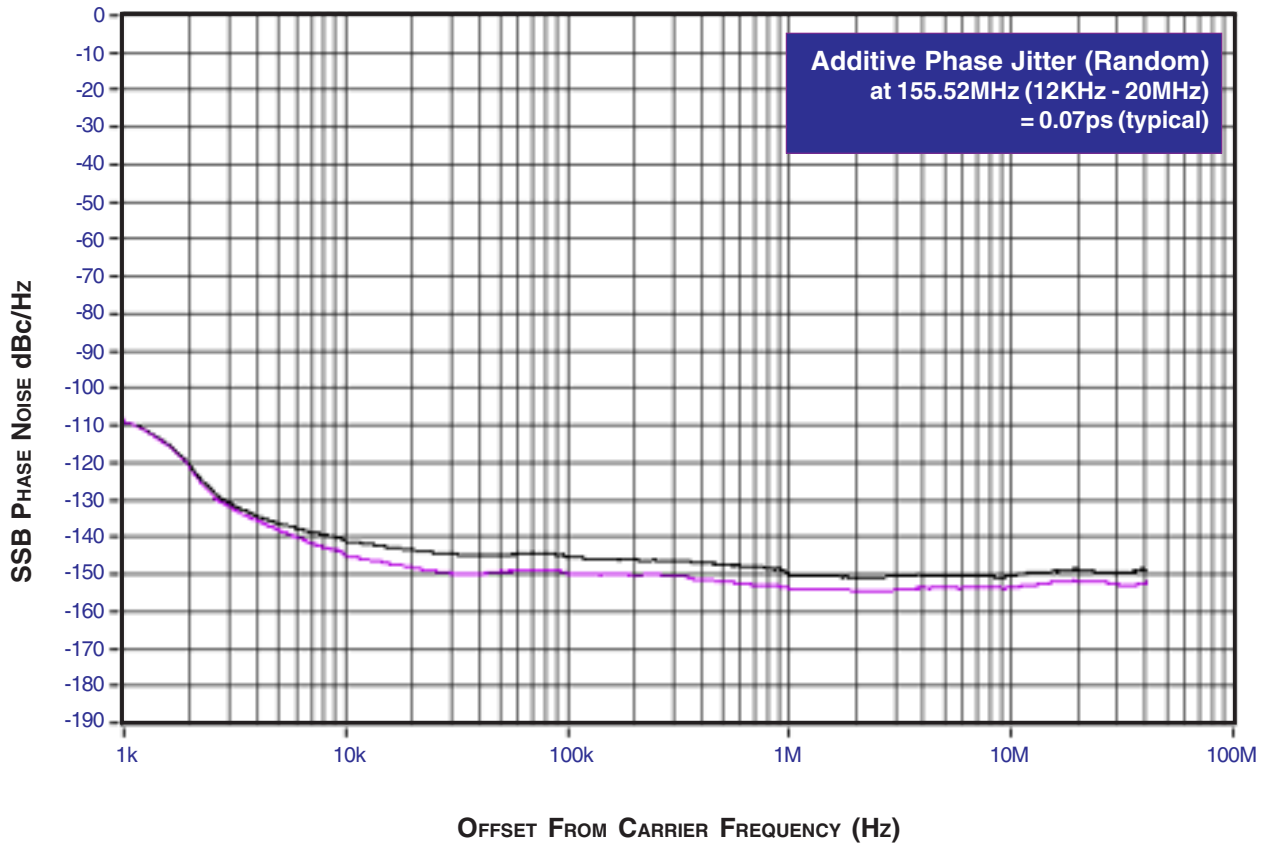

As with most timing specifications, phase noise measurements have issues. The primary issue relates to the limitations of the equipment. Often the noise floor of the equipment is higher than the noise floor of the device. This is illustrated

above. The device meets the noise floor of what is shown, but can actually be lower. The phase noise is dependant on the input source and measurement equipment.



**PARAMETER MEASUREMENT INFORMATION**

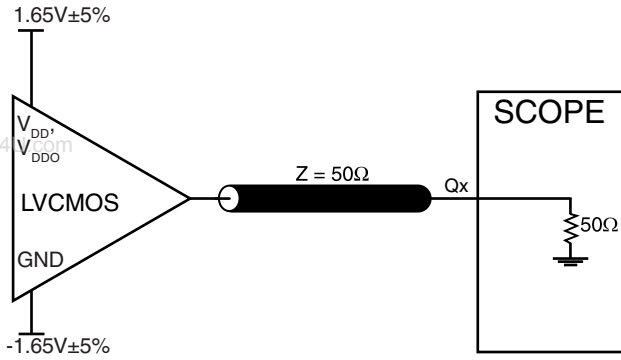

**3.3V CORE/3.3V OUTPUT LOAD AC TEST CIRCUIT**

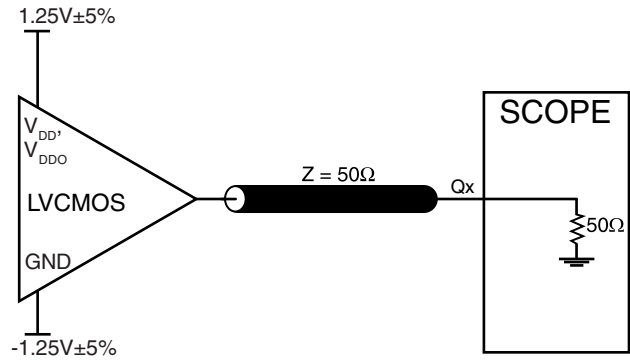

**2.5V CORE/2.5V OUTPUT LOAD AC TEST CIRCUIT**

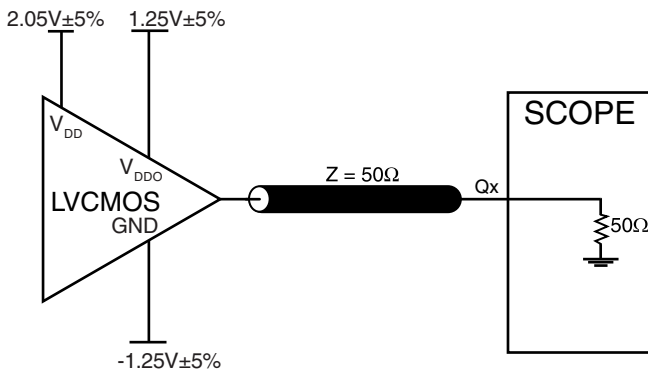

**3.3V CORE/2.5V OUTPUT LOAD AC TEST CIRCUIT**

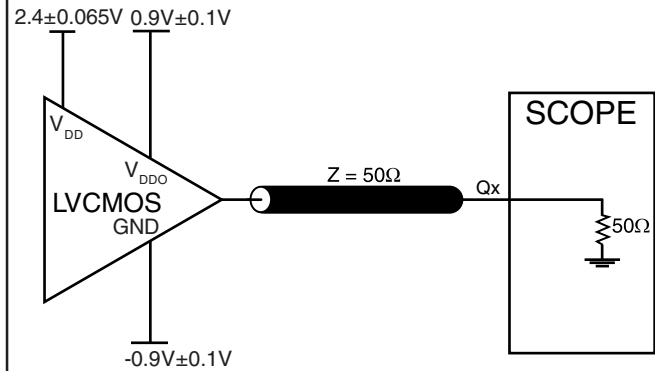

**3.3V CORE/1.8V OUTPUT LOAD AC TEST CIRCUIT**

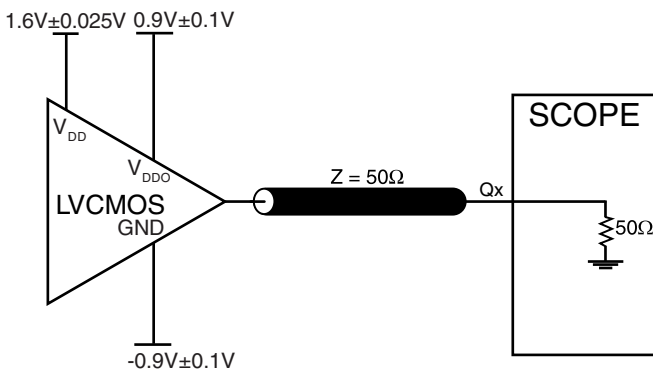

**2.5 CORE/1.8V OUTPUT LOAD AC TEST CIRCUIT**

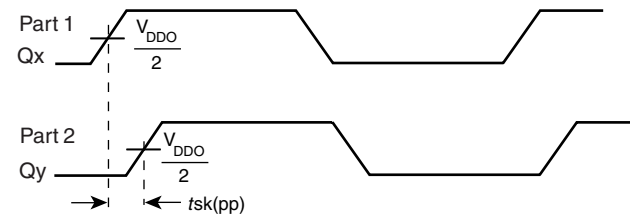

**PART-TO-PART SKEW**





www.DataSheet4U.com

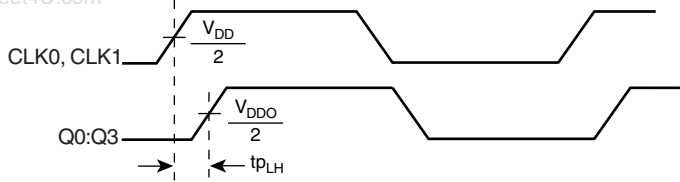

**PROPAGATION DELAY**

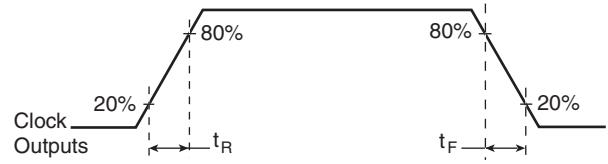

**OUTPUT RISE/FALL TIME**

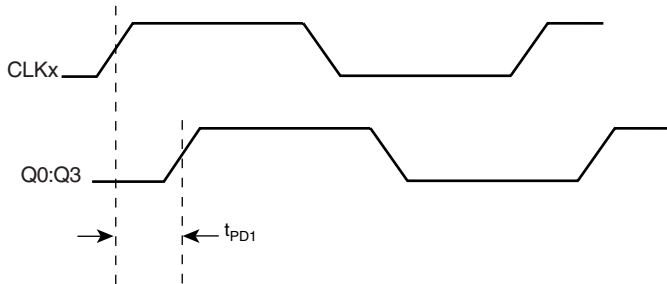

**INPUT SKEW**

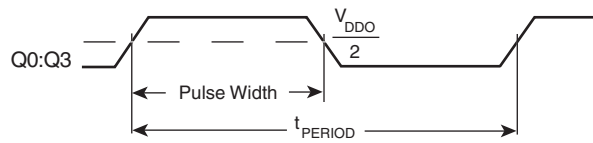

$$odc = \frac{t_{PW}}{t_{PERIOD}}$$

**OUTPUT DUTY CYCLE/PULSE WIDTH/PERIOD**



**RELIABILITY INFORMATION**

**TABLE 5.  $\theta_{JA}$  vs. AIR FLOW TABLE FOR 16 LEAD TSSOP**

www.DataSheet4U.com

$\theta_{JA}$ by Velocity (Linear Feet per Minute)			
	<b>0</b>	<b>200</b>	<b>500</b>
Single-Layer PCB, JEDEC Standard Test Boards	137.1°C/W	118.2°C/W	106.8°C/W
Multi-Layer PCB, JEDEC Standard Test Boards	89.0°C/W	81.8°C/W	78.1°C/W

**NOTE:** Most modern PCB designs use multi-layered boards. The data in the second row pertains to most designs.

**TRANSISTOR COUNT**

The transistor count for ICS83054I-01 is: 967



PACKAGE OUTLINE - G SUFFIX FOR 16 LEAD TSSOP

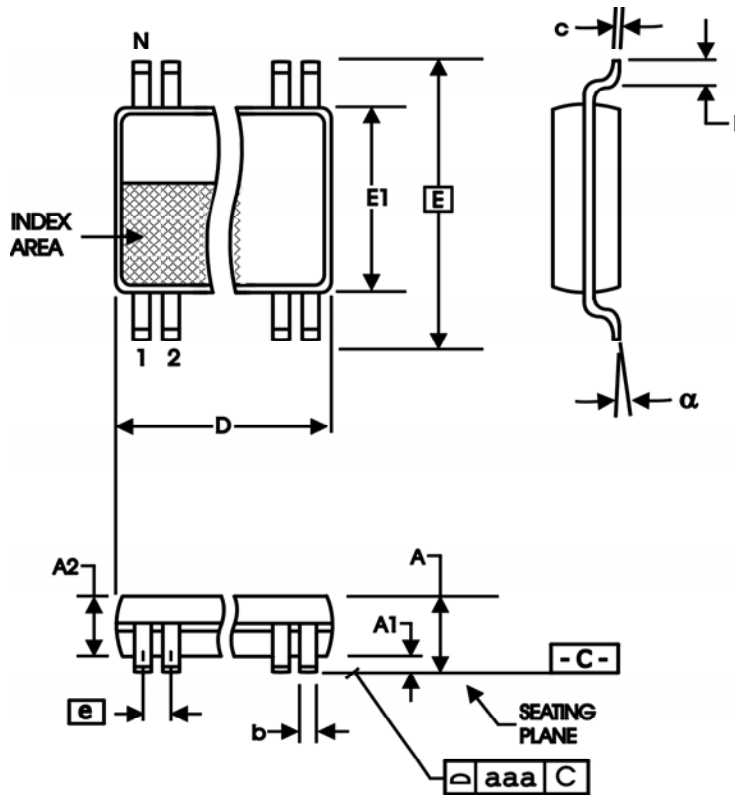

TABLE 6. PACKAGE DIMENSIONS

SYMBOL	Millimeters	
	Minimum	Maximum
N	16	
A	--	1.20
A1	0.05	0.15
A2	0.80	1.05
b	0.19	0.30
c	0.09	0.20
D	4.90	5.10
E	6.40 BASIC	
E1	4.30	4.50
e	0.65 BASIC	
L	0.45	0.75
alpha	0°	8°
aaa	--	0.10

Reference Document: JEDEC Publication 95, MO-153



Integrated  
Circuit  
Systems, Inc.

**PRELIMINARY**

**ICS83054I-01**  
4-BIT, 2:1,  
SINGLE-ENDED MULTIPLEXER

**TABLE 7. ORDERING INFORMATION**

Part/Order Number	Marking	Package	Count	Temperature
ICS83054AGI-01	3054AI01	16 Lead TSSOP	94 per tube	-40°C to 85°C
ICS83054AGI-01	3054AI01	16 Lead TSSOP on Tape and Reel	2500	-40°C to 85°C

www.DataSheet4U.com

The aforementioned trademark, HiPerClockS™ is a trademark of Integrated Circuit Systems, Inc. or its subsidiaries in the United States and/or other countries. While the information presented herein has been checked for both accuracy and reliability, Integrated Circuit Systems, Incorporated (ICS) assumes no responsibility for either its use or for infringement of any patents or other rights of third parties, which would result from its use. No other circuits, patents, or licenses are implied. This product is intended for use in normal commercial and industrial applications. Any other applications such as those requiring high reliability or other extraordinary environmental requirements are not recommended without additional processing by ICS. ICS reserves the right to change any circuitry or specifications without notice. ICS does not authorize or warrant any ICS product for use in life support devices or critical medical instruments.