



GENERAL DESCRIPTION



The ICS840-125 is a Gigabit Ethernet Oscillator Replacement and a member of the HiPerClocks™ family of high performance devices from ICS. The ICS840-125 uses a 25MHz crystal to synthesize 125MHz. The ICS840-125 has excellent jitter performance. The ICS840-125 is packaged in a small 8-pin TSSOP, making it ideal for use in systems with limited board space.

www.DataSheet4U.com

FEATURES

- One LVCMOS/LVTTL output, 15Ω output impedance
- Crystal oscillator interface designed for 25MHz, 18pF parallel resonant crystal
- Output frequency: 125MHz
- Random jitter: 3.7ps (typical)
- Deterministic jitter: 0.1ps (typical)
- 3.3V operating supply
- 0°C to 70°C ambient operating temperature
- Available in both standard and lead-free RoHS-compliant packages

BLOCK DIAGRAM

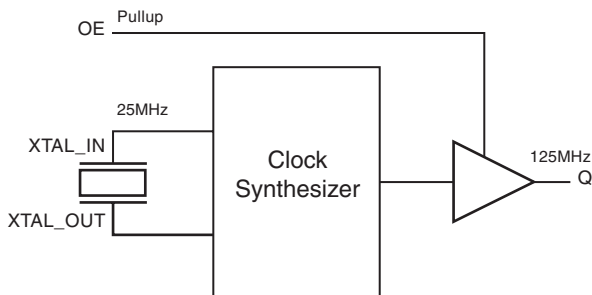

PIN ASSIGNMENT



ICS840-125

8-Lead TSSOP

4.40mm x 3.0mm x 0.925mm package body

G Package

Top View

ICS840-125

8-Lead SOIC

3.90mm x 4.92mm x 1.37mm body package

M Package

Top View



TABLE 1. PIN DESCRIPTIONS

Number	Name	Type		Description
1	V _{DD}	Power		Power supply pin.
2, 3	XTAL_OUT, XTAL_IN	Input		Crystal oscillator interface. XTAL_IN is the input, XTAL_OUT is the output.
4	OE	Input	Pullup	Output enable pin. When HIGH, Q output is enabled. When LOW, forces Q output to HiZ state. LVCMOS/LVTTL interface levels.
5	GND	Power		Power supply ground.
6	V _{DDO}	Power		Output supply pin.
7	Q	Output		Single-ended clock output. LVCMOS/LVTTL interface levels. 15Ω output impedance.
8	nc	Unused		No connect

NOTE: *Pullup* refers to internal input resistors. See Table 2, Pin Characteristics, for typical values.

TABLE 2. PIN CHARACTERISTICS

Symbol	Parameter	Test Conditions	Minimum	Typical	Maximum	Units
C _{IN}	Input Capacitance			4		pF
R _{PULLUP}	Input Pullup Resistor			51		kΩ
R _{OUT}	Output Impedance			15		Ω

TABLE 3. CONTROL FUNCTION TABLE

Control Inputs	Output
OE	Q
0	Hi-Z
1	Active



ABSOLUTE MAXIMUM RATINGS

Supply Voltage, V_{DD}	4.6V
Inputs, V_I	-0.5V to $V_{DD} + 0.5V$
Outputs, V_O	-0.5V to $V_{DDO} + 0.5V$
Package Thermal Impedance, θ_{JA}	
8 Lead TSSOP	101.7°C/W (0 mps)
8 Lead SOIC	112.7°C/W (0 lfpm)
Storage Temperature, T_{STG}	-65°C to 150°C

NOTE: Stresses beyond those listed under Absolute Maximum Ratings may cause permanent damage to the device. These ratings are stress specifications only. Functional operation of product at these conditions or any conditions beyond those listed in the *DC Characteristics* or *AC Characteristics* is not implied. Exposure to absolute maximum rating conditions for extended periods may affect product reliability.

TABLE 4A. POWER SUPPLY DC CHARACTERISTICS, $V_{DD} = V_{DDO} = 3.3V \pm 0.3V$, $T_A = 0^\circ C$ TO $70^\circ C$

Symbol	Parameter	Test Conditions	Minimum	Typical	Maximum	Units
V_{DD}	Power Supply Voltage		3.0	3.3	3.6	V
V_{DDO}	Output Supply Voltage		3.0	3.3	3.6	V
I_{DD}	Power Supply Current	OE = V_{DD} (output enabled)			96	mA
I_{DDO}	Output Supply Current				24	mA

TABLE 4B. LVCMOS/LVTTL DC CHARACTERISTICS, $V_{DD} = V_{DDO} = 3.3V \pm 0.3V$, $T_A = 0^\circ C$ TO $70^\circ C$

Symbol	Parameter	Test Conditions	Minimum	Typical	Maximum	Units
V_{IH}	Input High Voltage		2		$V_{DD} + 0.3$	V
V_{IL}	Input Low Voltage		-0.3		0.8	V
I_{IH}	Input High Current	$V_{DD} = V_{IN} = 3.6V$			5	μA
I_{IL}	Input Low Current	$V_{DD} = 3.6V, V_{IN} = 0V$	-150			μA
V_{OH}	Output High Voltage; NOTE 1		2.6			V
V_{OL}	Output Low Voltage; NOTE 1				0.5	V

NOTE 1: Outputs terminated with 50Ω to $V_{DDO}/2$. See Parameter Measurement Information Section, "3.3V Output Load Test Circuit".

TABLE 5. CRYSTAL CHARACTERISTICS

Parameter	Test Conditions	Minimum	Typical	Maximum	Units
Mode of Oscillation		Fundamental			
Frequency			25		MHz
Shunt Capacitance				7	pF
Drive Level				1	mW



TABLE 6. AC CHARACTERISTICS, $V_{DD} = V_{DDO} = 3.3V \pm 0.3V$, $T_A = 0^\circ C$ TO $70^\circ C$

Symbol	Parameter	Test Conditions	Minimum	Typical	Maximum	Units
f_{OUT}	Output Frequency			125		MHz
t_{DJ}	Deterministic Jitter; NOTE 1			0.1		ps
t_{RJ}	Random Jitter; NOTE 1			3.7		ps
t_{RMS}	RMS of Total Distribution (σ); NOTE 1			3.7		ps
t_{P-P}	Peak-to-Peak Jitter; NOTE 1			30		ps
t_{OSC}	Oscillation Start Up Time	Time at minimum operating voltage to be 0 s			10	ms
t_R / t_F	Output Rise/Fall Time	20% to 80%	250		900	ps
odc	Output Duty Cycle		48		52	%

Outputs terminated with 50Ω to $V_{DDO}/2$. See Parameter Measurement Information Section, "3.3V Output Load Test Circuit".

NOTE 1: Measured using Wavecrest SIA-3000.



PARAMETER MEASUREMENT INFORMATION

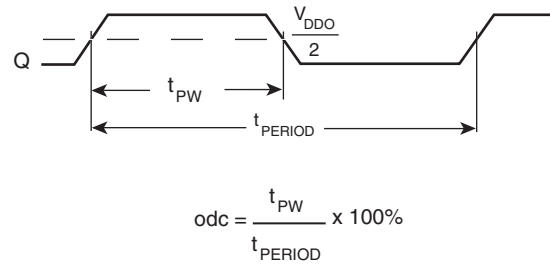
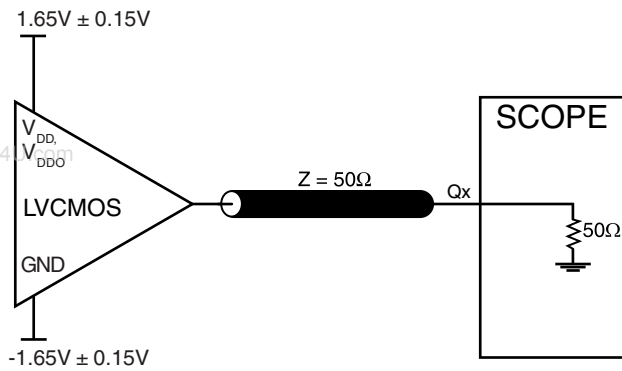

3.3V OUTPUT LOAD AC TEST CIRCUIT

OUTPUT DUTY CYCLE/PULSE WIDTH/PERIOD

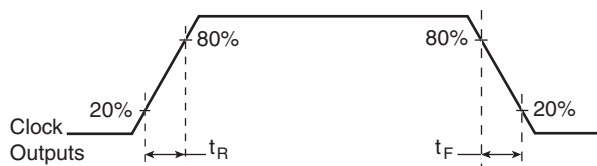

OUTPUT RISE/FALL TIME



APPLICATION INFORMATION

CRYSTAL INPUT INTERFACE

The ICS840-125 has been characterized with 18pF parallel resonant crystals. The capacitor values, C1 and C2, shown in Figure 1 below were determined using a 25MHz, 18pF parallel

resonant crystal and were chosen to minimize the ppm error. The optimum C1 and C2 values can be slightly adjusted for different board layouts.

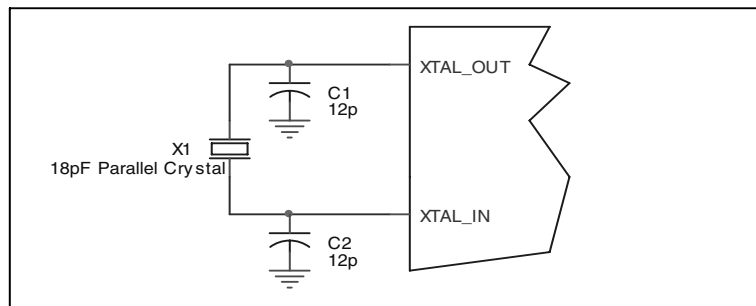

Figure 1. CRYSTAL INPUT INTERFACE



RELIABILITY INFORMATION

TABLE 7A. θ_{JA} VS. AIR FLOW TABLE FOR 8 LEAD TSSOP

θ_{JA} by Velocity (Meters per Second)			
	0	1	2.5
Multi-Layer PCB, JEDEC Standard Test Boards	101.7°C/W	90.5°C/W	89.8°C/W

TABLE 7B. θ_{JA} VS. AIR FLOW TABLE 8 LEAD SOIC

θ_{JA} by Velocity (Linear Feet per Minute)			
	0	200	500
Single-Layer PCB, JEDEC Standard Test Boards	153.3°C/W	128.5°C/W	115.5°C/W
Multi-Layer PCB, JEDEC Standard Test Boards	112.7°C/W	103.3°C/W	97.1°C/W

NOTE: Most modern PCB designs use multi-layered boards. The data in the second row pertains to most designs.

TRANSISTOR COUNT

The transistor count for ICS840-125 is: 2423



PACKAGE OUTLINE - G SUFFIX FOR 8 LEAD TSSOP

PACKAGE OUTLINE - M SUFFIX FOR 8 LEAD SOIC

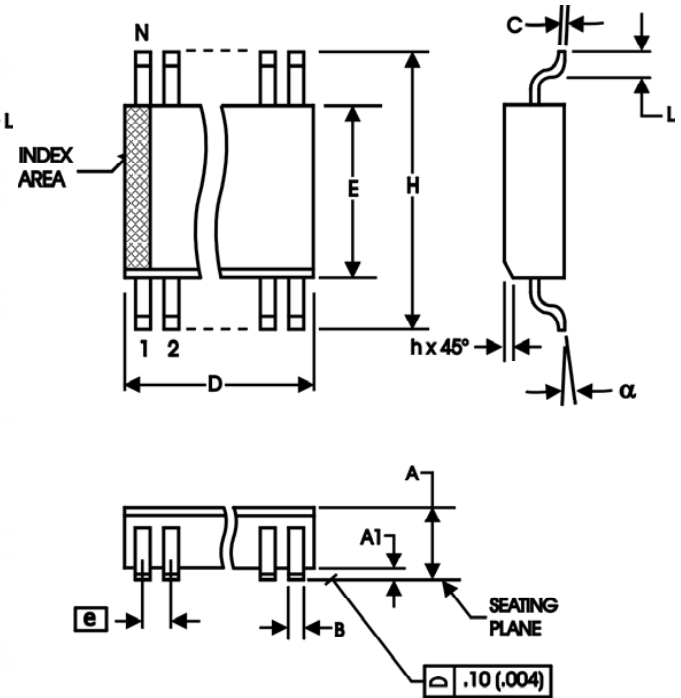
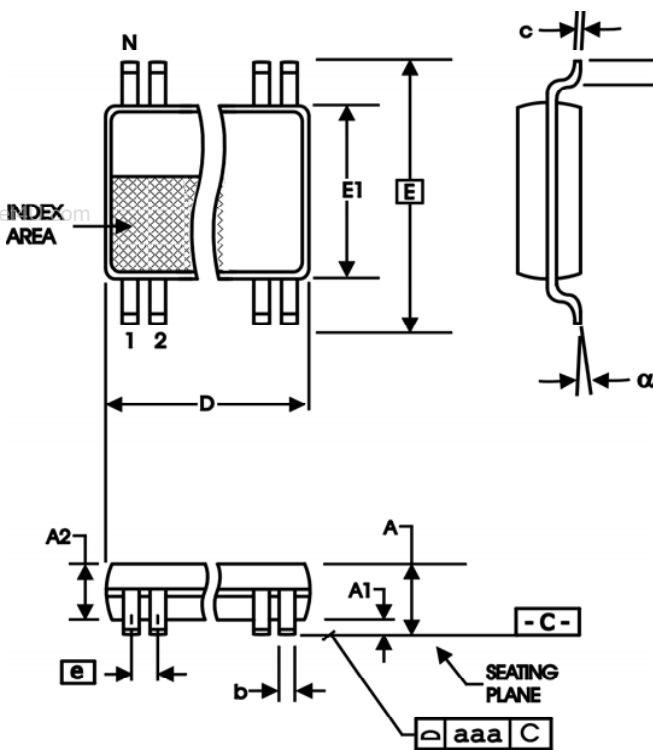

TABLE 8A. PACKAGE DIMENSIONS

SYMBOL	Millimeters	
	Minimum	Maximum
N	8	
A	--	1.20
A1	0.05	0.15
A2	0.80	1.05
b	0.19	0.30
c	0.09	0.20
D	2.90	3.10
E	6.40 BASIC	
E1	4.30	4.50
e	0.65 BASIC	
L	0.45	0.75
α	0°	8°
aaa	--	0.10

TABLE 8B. PACKAGE DIMENSIONS

SYMBOL	Millimeters	
	MINIMUM	MAXIMUM
N	8	
A	1.35	1.75
A1	0.10	0.25
B	0.33	0.51
C	0.19	0.25
D	4.80	5.00
E	3.80	4.00
e	1.27 BASIC	
H	5.80	6.20
h	0.25	0.50
L	0.40	1.27
α	0°	8°

Reference Document: JEDEC Publication 95, MS-012



TABLE 9. ORDERING INFORMATION

Part/Order Number	Marking	Package	Shipping Packaging	Temperature
ICS840AG-125	AG125	8 lead TSSOP	tube	0°C to 70°C
ICS840AG-125T	AG125	8 lead TSSOP	2500 tape & reel	0°C to 70°C
ICS840AG-125LF	TBD	8 lead "Lead-Free" TSSOP	tube	0°C to 70°C
ICS840AG-125LFT	TBD	8 lead "Lead-Free" TSSOP	2500 tape & reel	0°C to 70°C
ICS840AM-125	840AM125	8 lead SOIC	tube	0°C to 70°C
ICS840AM-125T	840AM125	8 lead SOIC	2500 tape & reel	0°C to 70°C
ICS840AM-125LF	TBD	8 lead "Lead-Free" SOIC	tube	0°C to 70°C
ICS840AM-125LFT	TBD	8 lead "Lead-Free" SOIC	2500 tape & reel	0°C to 70°C

NOTE: Parts that are ordered with an "LF" suffix to the part number are the Pb-Free configuration and are RoHS compliant.

The aforementioned trademark, HiPerClockS is a trademark of Integrated Circuit Systems, Inc. or its subsidiaries in the United States and/or other countries. While the information presented herein has been checked for both accuracy and reliability, Integrated Circuit Systems, Incorporated (ICS) assumes no responsibility for either its use or for infringement of any patents or other rights of third parties, which would result from its use. No other circuits, patents, or licenses are implied. This product is intended for use in normal commercial applications. Any other applications such as those requiring extended temperature range, high reliability, or other extraordinary environmental requirements are not recommended without additional processing by ICS. ICS reserves the right to change any circuitry or specifications without notice. ICS does not authorize or warrant any ICS product for use in life support devices or critical medical instruments.