



Integrated
Circuit
Systems, Inc.

ICS844251I-15

FEMTOCLOCKS™ CRYSTAL-TO-LVDS CLOCK GENERATOR

GENERAL DESCRIPTION



The ICS844251I-15 is an Ethernet Clock Generator and a member of the HiPerClocks™ family of high performance devices from ICS. The ICS844251I-15 uses an 18pF parallel resonant crystal over the range of 23.2MHz - 30MHz. For Ethernet applications, a 25MHz crystal is used. The device has excellent <1ps phase jitter performance, over the 1.875MHz - 20MHz integration range. The ICS844251I-15 is packaged in a small 8-pin TSSOP, making it ideal for use in systems with limited board space.

FEATURES

- One Differential LVDS output
- Crystal oscillator interface, 18pF parallel resonant crystal (23.2MHz - 30MHz)
- Output frequency ranges: 116MHz - 150MHz and 580MHz - 750MHz
- VCO range: 580MHz - 750MHz
- RMS phase jitter @ 125MHz, using a 25MHz crystal (1.875MHz - 20MHz): 0.46ps (typical)
- 3.3V or 2.5V operating supply
- -40°C to 85°C ambient operating temperature
- Available in both standard and lead-free RoHS-compliant packages

COMMON CONFIGURATION TABLE

Inputs					Output Frequency (MHz)
Crystal Frequency (MHz)	FREQ_SEL	M	N	Multiplication Value M/N	
25	1	25	1	25	625
26.667	1	25	1	25	666.67
25	0	25	5	5	125
26.667	0	25	5	5	133.33

BLOCK DIAGRAM

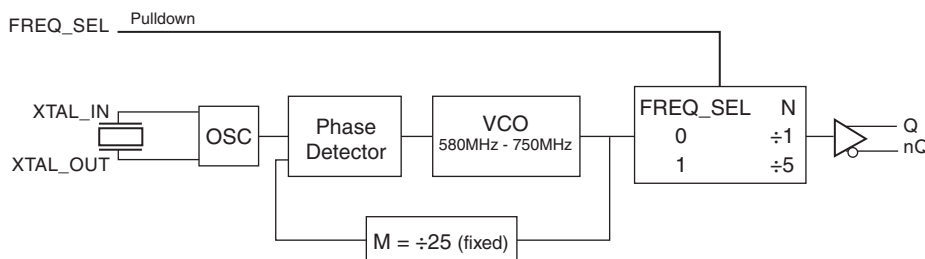

PIN ASSIGNMENT

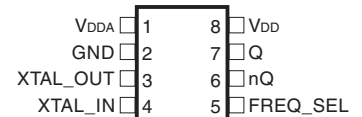

ICS844251I-15

8-Lead TSSOP
4.4mm x 3.0mm x 0.925mm
package body
G Package
Top View

The Preliminary Information presented herein represents a product in prototyping or pre-production. The noted characteristics are based on initial product characterization. Integrated Circuit Systems, Incorporated (ICS) reserves the right to change any circuitry or specifications without notice.



TABLE 1. PIN DESCRIPTIONS

Number	Name	Type		Description
1	V _{DDA}	Power		Analog supply pin.
2	GND	Power		Power supply ground.
3, 4	XTAL_OUT, XTAL_IN	Input		Crystal oscillator interface. XTAL_IN is the input, XTAL_OUT is the output.
5	FREQ_SEL	Input	Pulldown	Frequency select pin. LVCMOS/LVTTL interface levels.
6, 7	nQ, Q	Output		Differential clock outputs. LVDS interface levels.
8	V _{DD}	Power		Power supply pin.

NOTE: *Pullup* refers to internal input resistors. See Table 2, Pin Characteristics, for typical values.

TABLE 2. PIN CHARACTERISTICS

Symbol	Parameter	Test Conditions	Minimum	Typical	Maximum	Units
C _{IN}	Input Capacitance			4		pF
R _{PULLDOWN}	Input Pulldown Resistor			51		kΩ



ABSOLUTE MAXIMUM RATINGS

Supply Voltage, V_{DD}	4.6V
Inputs, V_i	-0.5V to $V_{DD} + 0.5V$
Outputs, I_o (LVDS)	
Continuous Current	10mA
Surge Current	15mA
Package Thermal Impedance, θ_{JA}	101.7°C/W (0 mps)
Storage Temperature, T_{STG}	-65°C to 150°C

NOTE: Stresses beyond those listed under Absolute Maximum Ratings may cause permanent damage to the device. These ratings are stress specifications only. Functional operation of product at these conditions or any conditions beyond those listed in the *DC Characteristics* or *AC Characteristics* is not implied. Exposure to absolute maximum rating conditions for extended periods may affect product reliability.

TABLE 3A. POWER SUPPLY DC CHARACTERISTICS, $V_{DD} = V_{DDA} = 3.3V \pm 5\%$, $T_A = -40^\circ C$ TO $85^\circ C$

Symbol	Parameter	Test Conditions	Minimum	Typical	Maximum	Units
V_{DD}	Power Supply Voltage		3.135	3.3	3.465	V
V_{DDA}	Analog Supply Voltage		3.135	3.3	3.465	V
I_{DD}	Power Supply Current			100		mA
I_{DDA}	Analog Supply Current			8		mA

TABLE 3B. POWER SUPPLY DC CHARACTERISTICS, $V_{DD} = V_{DDA} = 2.5V \pm 5\%$, $T_A = -40^\circ C$ TO $85^\circ C$

Symbol	Parameter	Test Conditions	Minimum	Typical	Maximum	Units
V_{DD}	Power Supply Voltage		2.375	2.5	2.625	V
V_{DDA}	Analog Supply Voltage		2.375	2.5	2.625	V
I_{DD}	Power Supply Current			95		mA
I_{DDA}	Analog Supply Current			8		mA

TABLE 3C. LVCMOS/LVTTL DC CHARACTERISTICS, $V_{DD} = V_{DDA} = 3.3V \pm 5\%$ OR $2.5V \pm 5\%$, $T_A = -40^\circ C$ TO $85^\circ C$

Symbol	Parameter	Test Conditions	Minimum	Typical	Maximum	Units
V_{IH}	Input High Voltage	$V_{DD} = 3.3V$	2		$V_{DD} + 0.3$	V
		$V_{DD} = 2.5V$	1.7		$V_{DD} + 0.3$	V
V_{IL}	Input Low Voltage	$V_{DD} = 3.3V$	-0.3		0.8	V
		$V_{DD} = 2.5V$	-0.3		0.7	V
I_{IH}	Input High Current	$V_{DD} = V_{IN} = 3.465V$ or $2.625V$			150	μA
I_{IL}	Input Low Current	$V_{DD} = 3.465V$ or $2.625V$, $V_{IN} = 0V$	-5			μA



TABLE 3D. LVDS DC CHARACTERISTICS, $V_{DD} = V_{DDA} = 3.3V \pm 5\%$, $T_A = -40^\circ C$ TO $85^\circ C$

Symbol	Parameter	Test Conditions	Minimum	Typical	Maximum	Units
V_{OD}	Differential Output Voltage			400		mV
ΔV_{OD}	V_{OD} Magnitude Change			TBD		mV
V_{OS}	Offset Voltage			1.4		V
ΔV_{OS}	V_{OS} Magnitude Change			TBD		mV

TABLE 3E. LVDS DC CHARACTERISTICS, $V_{DD} = V_{DDA} = 2.5V \pm 5\%$, $T_A = -40^\circ C$ TO $85^\circ C$

Symbol	Parameter	Test Conditions	Minimum	Typical	Maximum	Units
V_{OD}	Differential Output Voltage			400		mV
ΔV_{OD}	V_{OD} Magnitude Change			TBD		mV
V_{OS}	Offset Voltage			1.15		V
ΔV_{OS}	V_{OS} Magnitude Change			TBD		mV

TABLE 4. CRYSTAL CHARACTERISTICS

Parameter	Test Conditions	Minimum	Typical	Maximum	Units
Mode of Oscillation		Fundamental			
Frequency		23.2		30	MHz
Equivalent Series Resistance (ESR)				50	Ω
Shunt Capacitance				7	pF
Drive Level				1	mW

TABLE 5A. AC CHARACTERISTICS, $V_{DD} = V_{DDA} = 3.3V \pm 5\%$, $T_A = -40^\circ C$ TO $85^\circ C$

Symbol	Parameter	Test Conditions	Minimum	Typical	Maximum	Units
f_{OUT}	Output Frequency	$f_{SEL} = 0$	116		150	MHz
		$f_{SEL} = 1$	580		750	MHz
$f_{jit}(\emptyset)$	RMS Phase Jitter (Random); NOTE 1	125MHz @ Integration Range: 1.875MHz - 20MHz		0.46		ps
		625MHz @ Integration Range: 1.875MHz - 20MHz		0.35		ps
t_R / t_F	Output Rise/Fall Time	20% to 80%		300		ps
odc	Output Duty Cycle			50		%

NOTE 1: Please refer to the Phase Noise Plots following this section.

TABLE 5B. AC CHARACTERISTICS, $V_{DD} = V_{DDA} = 2.5V \pm 5\%$, $T_A = -40^\circ C$ TO $85^\circ C$

Symbol	Parameter	Test Conditions	Minimum	Typical	Maximum	Units
f_{OUT}	Output Frequency	$f_{SEL} = 0$	116		150	MHz
		$f_{SEL} = 1$	580		750	MHz
$f_{jit}(\emptyset)$	RMS Phase Jitter (Random); NOTE 1	125MHz @ Integration Range: 1.875MHz - 20MHz		0.46		ps
		625MHz @ Integration Range: 1.875MHz - 20MHz		0.35		ps
t_R / t_F	Output Rise/Fall Time	20% to 80%		300		ps
odc	Output Duty Cycle			50		%

NOTE 1: Please refer to the Phase Noise Plots following this section.



TYPICAL PHASE NOISE AT 125MHz @ 3.3V

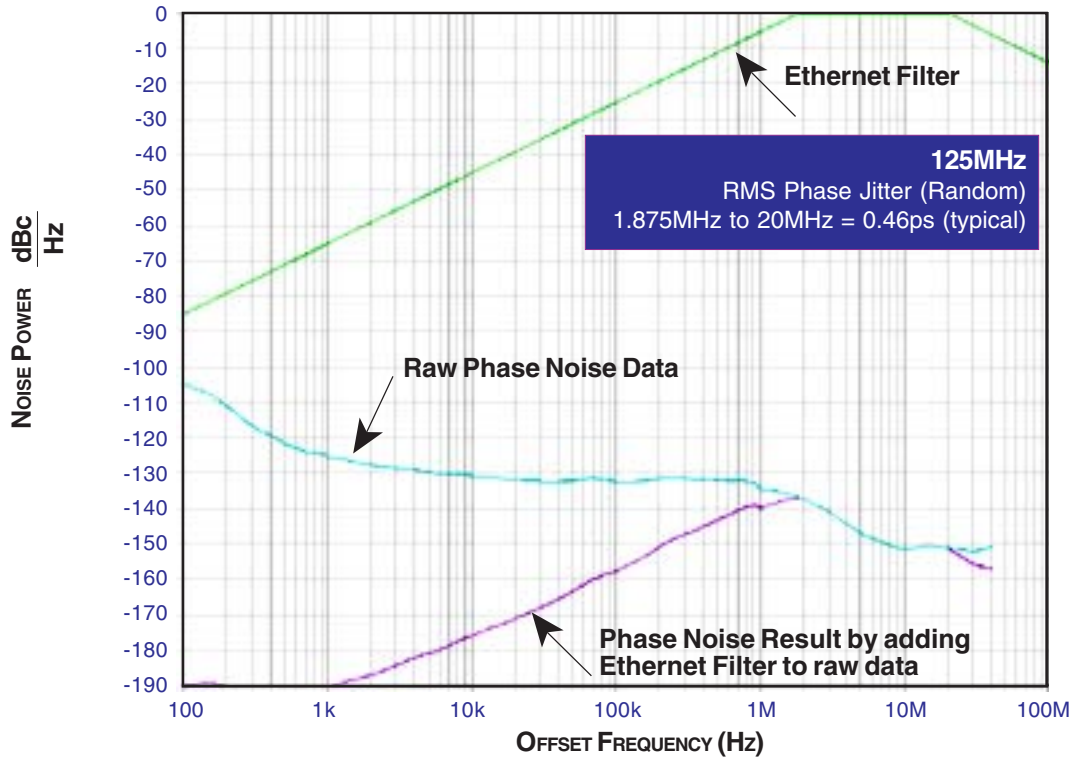

TYPICAL PHASE NOISE AT 625MHz @ 3.3V

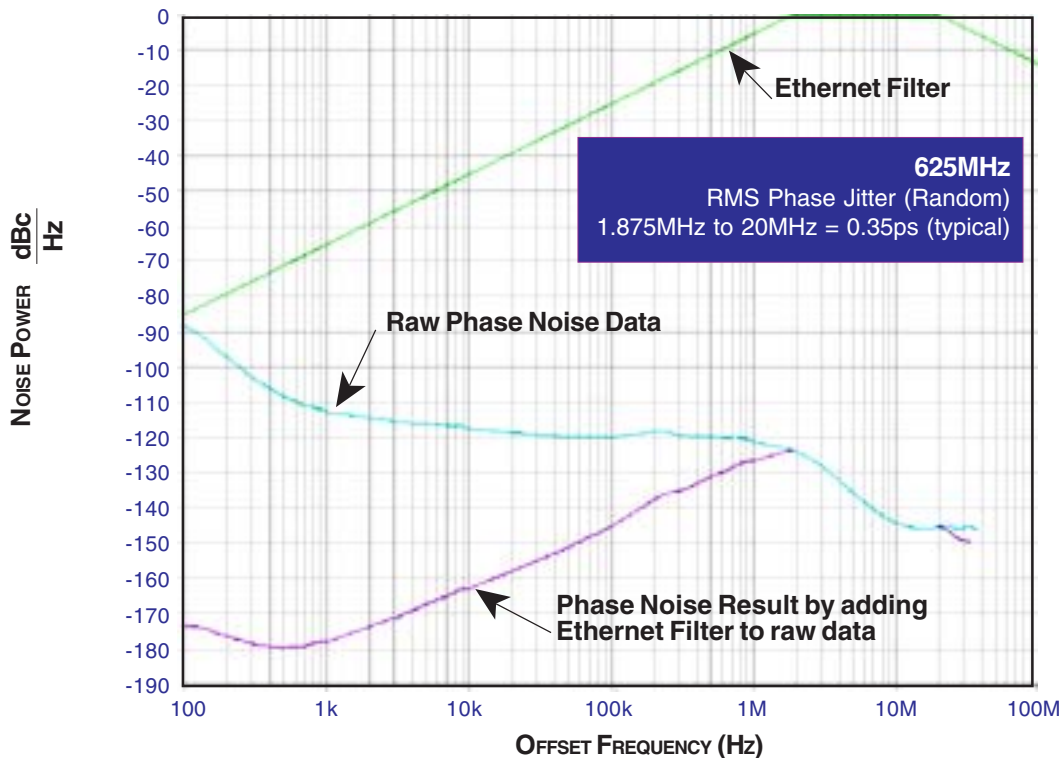



PARAMETER MEASUREMENT INFORMATION

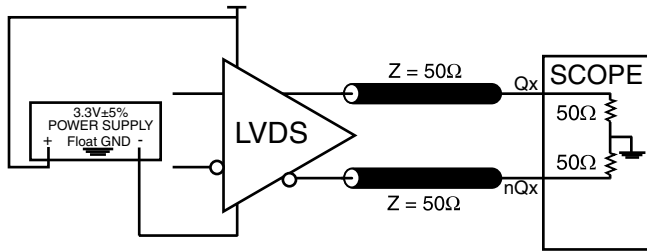

LVDS 3.3V OUTPUT LOAD AC TEST CIRCUIT

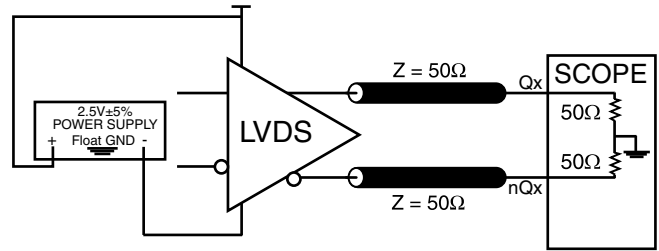

LVDS 2.5V OUTPUT LOAD AC TEST CIRCUIT

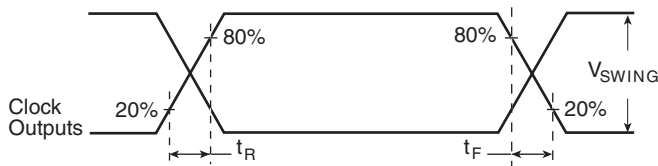

OUTPUT RISE/FALL TIME

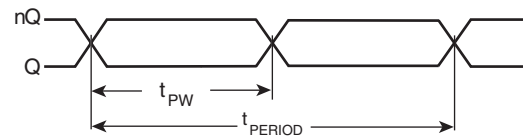

$$\text{odc} = \frac{t_{PW}}{t_{PERIOD}} \times 100\%$$

OUTPUT DUTY CYCLE/PULSE WIDTH/PERIOD

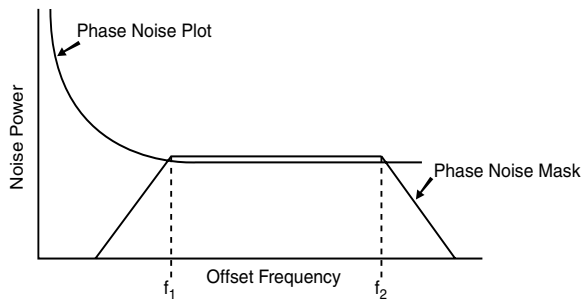

$$\text{RMS Jitter} = \sqrt{\text{Area Under the Masked Phase Noise Plot}}$$

RMS PHASE JITTER

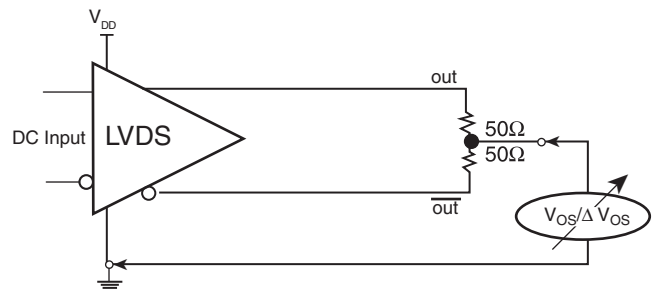

OFFSET VOLTAGE SETUP

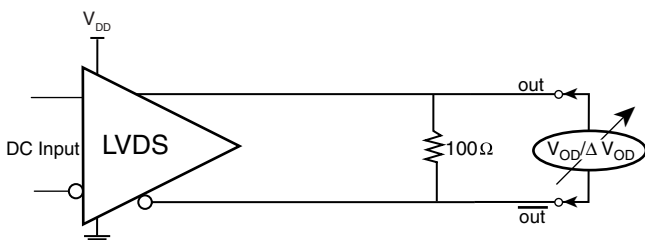

DIFFERENTIAL OUTPUT VOLTAGE SETUP



APPLICATION INFORMATION

POWER SUPPLY FILTERING TECHNIQUES

As in any high speed analog circuitry, the power supply pins are vulnerable to random noise. The ICS844251I-15 provides separate power supplies to isolate any high switching noise from the outputs to the internal PLL. V_{DD} and V_{DDA} should be individually connected to the power supply plane through vias, and bypass capacitors should be used for each pin. To achieve optimum jitter performance, power supply isolation is required. *Figure 1* illustrates how a 10Ω resistor along with a $10\mu\text{F}$ and a $.01\mu\text{F}$ bypass capacitor should be connected to each V_{DDA} pin. The 10Ω resistor can also be replaced by a ferrite bead.

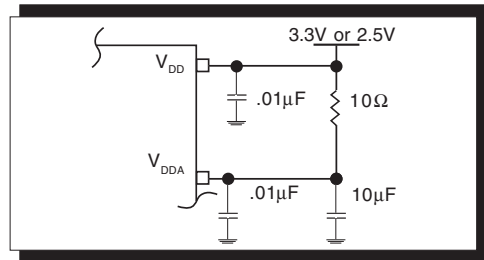

FIGURE 1. POWER SUPPLY FILTERING

CRYSTAL INPUT INTERFACE

The ICS844251I-15 has been characterized with 18pF parallel resonant crystals. The capacitor values, C1 and C2, shown in *Figure 2* below were determined using a 25MHz, 18pF parallel

resonant crystal and were chosen to minimize the ppm error. The optimum C1 and C2 values can be slightly adjusted for different board layouts.

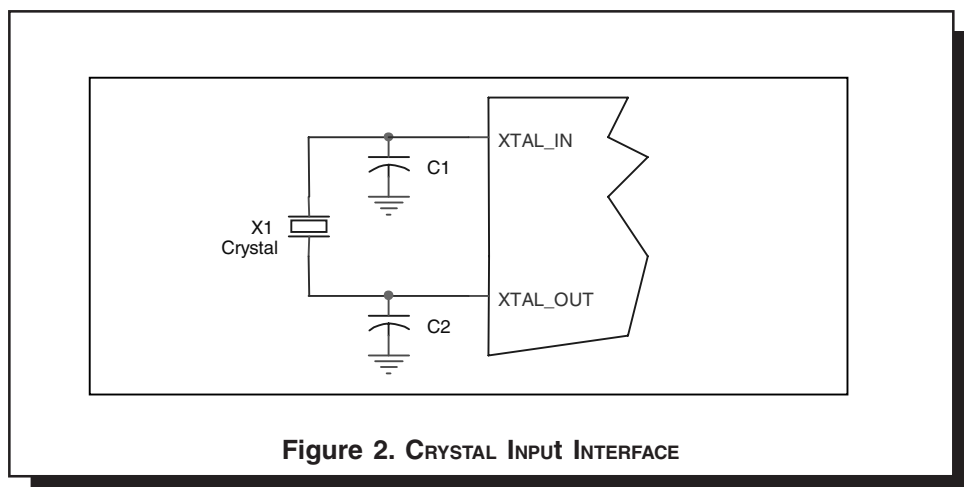

Figure 2. CRYSTAL INPUT INTERFACE



3.3V, 2.5V LVDS DRIVER TERMINATION

A general LVDS interface is shown in *Figure 3*. In a 100Ω differential transmission line environment, LVDS drivers require a matched load termination of 100Ω across near the receiver input.

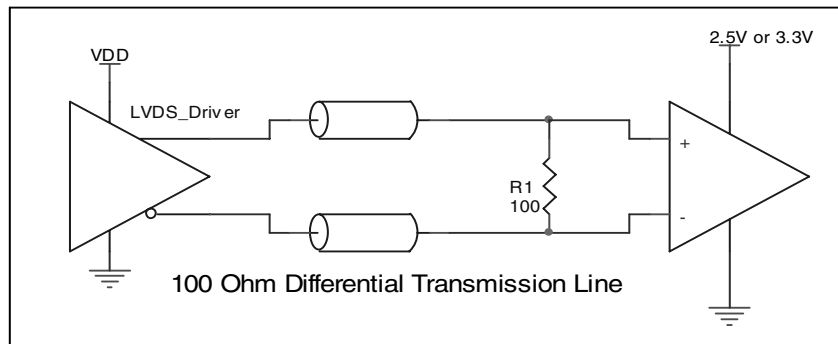

FIGURE 3. TYPICAL LVDS DRIVER TERMINATION



Integrated
Circuit
Systems, Inc.

PRELIMINARY

ICS844251I-15
FEMTOCLOCKS™ CRYSTAL-TO-LVDS
CLOCK GENERATOR

RELIABILITY INFORMATION

TABLE 6. θ_{JA} vs. AIR FLOW TABLE FOR 8 LEAD TSSOP

θ_{JA} by Velocity (Meters per Second)			
	0	1	2.5
Multi-Layer PCB, JEDEC Standard Test Boards	101.7°C/W	90.5°C/W	89.8°C/W

TRANSISTOR COUNT

The transistor count for ICS844251I-15 is: 2398



Integrated
Circuit
Systems, Inc.

PRELIMINARY

ICS844251I-15
FEMTOCLOCKS™ CRYSTAL-TO-LVDS
CLOCK GENERATOR

PACKAGE OUTLINE - G SUFFIX FOR 8 LEAD TSSOP

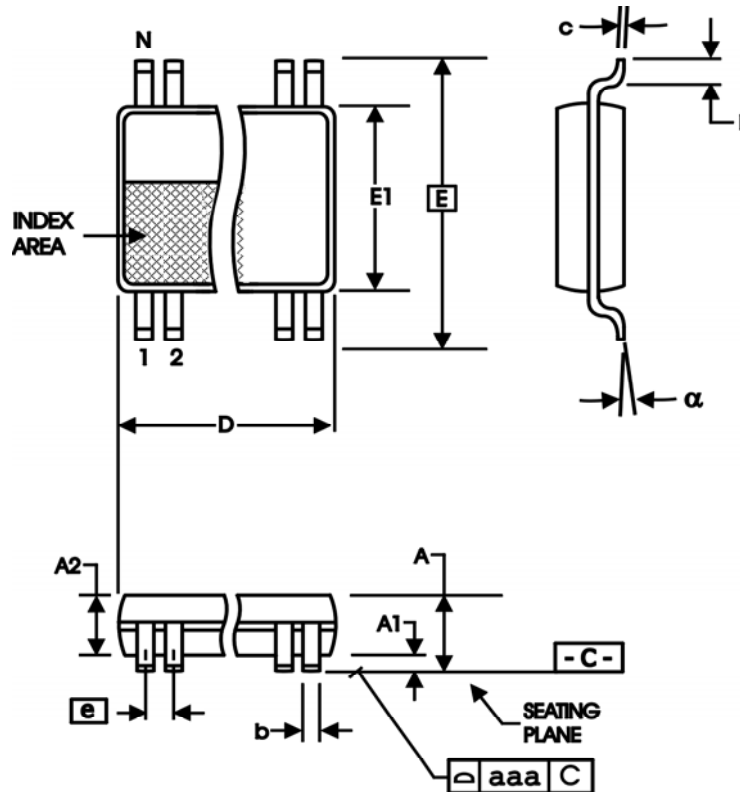

TABLE 7. PACKAGE DIMENSIONS

SYMBOL	Millimeters	
	Minimum	Maximum
N	8	
A	--	1.20
A1	0.05	0.15
A2	0.80	1.05
b	0.19	0.30
c	0.09	0.20
D	2.90	3.10
E	6.40 BASIC	
E1	4.30	4.50
e	0.65 BASIC	
L	0.45	0.75
α	0°	8°
aaa	--	0.10

Reference Document: JEDEC Publication 95, MO-153



Integrated
Circuit
Systems, Inc.

PRELIMINARY

ICS844251I-15 FEMTOCLOCKS™ CRYSTAL-TO-LVDS CLOCK GENERATOR

TABLE 8. ORDERING INFORMATION

Part/Order Number	Marking	Package	Shipping Packaging	Temperature
ICS844251BGI-15	4BI15	8 Lead TSSOP	tube	-40°C to 85°C
ICS844251BGI-15T	4BI15	8 Lead TSSOP	2500 tape & reel	-40°C to 85°C
ICS844251BGI-15LF	TBD	8 Lead "Lead-Free" TSSOP	tube	-40°C to 85°C
ICS844251BGI-15LFT	TBD	8 Lead "Lead-Free" TSSOP	2500 tape & reel	-40°C to 85°C

NOTE: Parts that are ordered with an "LF" suffix to the part number are the Pb-Free configuration and are RoHS compliant.

The aforementioned trademarks, HiPerClockS and FemtoClocks are trademarks of Integrated Circuit Systems, Inc. or its subsidiaries in the United States and/or other countries. While the information presented herein has been checked for both accuracy and reliability, Integrated Circuit Systems, Incorporated (ICS) assumes no responsibility for either its use or for infringement of any patents or other rights of third parties, which would result from its use. No other circuits, patents, or licenses are implied. This product is intended for use in normal commercial and industrial applications. Any other applications such as those requiring high reliability or other extraordinary environmental requirements are not recommended without additional processing by ICS. ICS reserves the right to change any circuitry or specifications without notice. ICS does not authorize or warrant any ICS product for use in life support devices or critical medical instruments.