



# Frequency Timing Generator for PENTIUM II Systems

## General Description

The ICS9250-09 is a main clock synthesizer chip for Pentium II based systems using Rambus Interface DRAMs. This chip provides all the clocks required for such a system when used with a Direct Rambus Clock Generator(DRCG) chip such as the ICS9211-01.

Spread Spectrum may be enabled by driving the SPREAD# pin active. Spread spectrum typically reduces system EMI by 8dB to 10dB. This simplifies EMI qualification without resorting to board design iterations or costly shielding. The ICS9250-09 employs a proprietary closed loop design, which tightly controls the percentage of spreading over process and temperature variations.

The CPU/2 clocks are inputs to the DRCG.

## Key Specification

- CPU Output Jitter: <250ps
- CPU/2 Output Jitter: <250ps
- IOAPIC Output Jitter: <500ps
- 48MHz, 3V66, PCI Output Jitter: <500ps
- Ref Output Jitter: <1000ps
- CPU Output Skew: <175ps
- CPU/2 Output Skew: <175ps
- IOAPIC Output Skew <250ps
- PCI Output Skew: <500ps
- 3V66 Output Skew <250ps
- CPU to 3V66 Output Offset: 0.0 - 1.5ns (CPU leads)
- 3V66 to PCI Output Offset: 1.5 - 4.0ns (3V66 leads)
- CPU to IOAPIC Output Offset 1.5 - 4.0ns (CPU leads)

## Features

- Generates the following system clocks:
  - 4 CPU clocks (2.5V, 100/133MHz)
  - 8 PCI clocks, including 1 free-running (3.3V, 33MHz)
  - 2 CPU/2 clocks (2.5V, 50/66MHz)
  - 3 IOAPIC clocks (2.5V, 16.67MHz)
  - 4 Fixed frequency 66MHz clocks(3.3V, 66MHz)
  - 2 REF clocks(3.3V, 14.318MHz)
  - 1 USB clock (3.3V, 48MHz)
- Efficient power management through PD#, CPU\_STOP# and PCI\_STOP#.
- 0.5% typical down spread modulation on CPU, PCI, IOAPIC, 3V66 and CPU/2 output clocks.
- Uses external 14.318MHz crystal.

## Pin Configuration

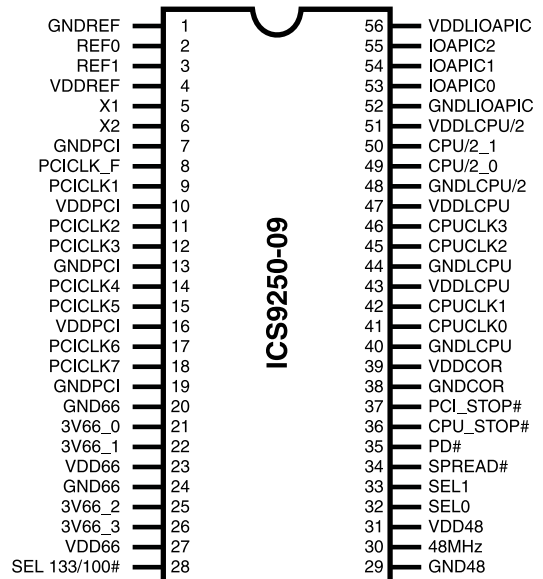

**56-pin SSOP**

## Block Diagram

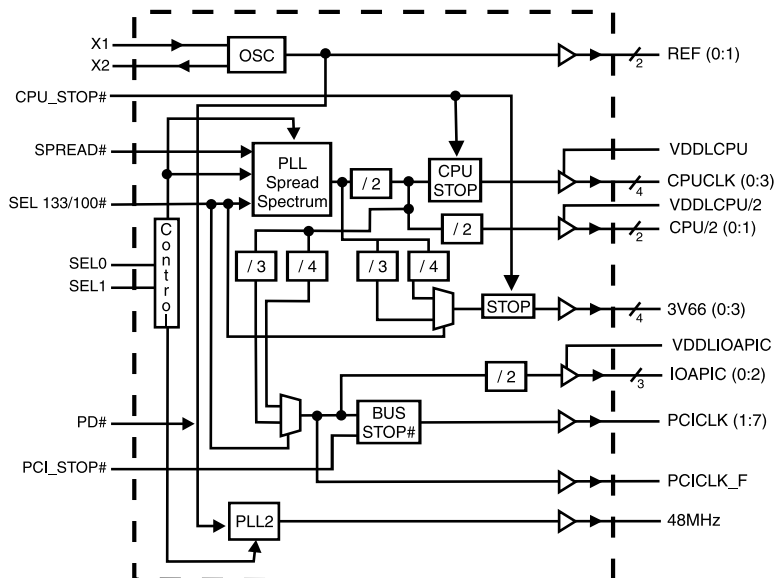



## Pin Descriptions

Pin number	Pin name	Type	Description
1	GNDREF	PWR	Gnd pin for REF clocks
2, 3	REF(0:1)	OUT	14.318MHz reference clock outputs at 3.3V
4	VDDREF	PWR	Power pin for REF clocks
5	X1	IN	XTAL_IN 14.318MHz crystal input
6	X2	OUT	XTAL_OUT Crystal output
7, 13, 19	GNDPCI	PWR	Gnd pin for PCICLKs
8	PCICLK_F	OUT	Free running PCI clock at 3.3V. Synchronous to CPU clocks. Not affected by the PCI_STOP# input.
9, 11, 12, 14, 15, 17, 18	PCICLK[1:7]	OUT	PCI clock outputs at 3.3V. Synchronous to CPU clocks.
10, 16	VDDPCI	PWR	3.3Volts power pin for PCICLKs
20, 24	GND66	PWR	Gnd pin for 3V66 outputs
21, 22, 25, 26	3V66[0:3]	OUT	66MHz outputs at 3.3V. These outputs are stopped when CPU_STOP# is driven active..
23, 27	VDD66	PWR	power pin for the 3V66 clocks.
28	SEL 133/100#	IN	This selects the frequency for the CPU and CPU/2 outputs. High = 133MHz, Low=100MHz
29	GND48	PWR	Ground pin for the 48MHz output
30	48MHz	OUT	Fixed 48MHz clock output. 3.3V
31	VDD48	PWR	Power pin for the 48MHz output.
32, 33	SEL[0:1]	IN	Function select pins. See truth table for details.
34	SPREAD#	IN	Enables spread spectrum when active(Low). modulates all the CPU, PCI, IOAPIC, 3V66 and CPU/2 clocks. Does not affect the REF and 48MHz clocks. 0.5% down spread modulation.
35	PD#	IN	This asynchronous input powers down the chip when drive active(Low). The internal PLLs are disabled and all the output clocks are held at a Low state.
36	CPU_STOP#	IN	This asynchronous input halts the CPUCLK[0:3] and the 3V66[0:3] clocks at logic "0" when driven active(Low). Does not affect the CPU/2 clocks.
37	PCI_STOP#	IN	This asynchronous input halts the PCICLK[1:7] at logic"0" when driven active(Low). PCICLK_F is not affected by this input.
38	GNDCOR	PWR	Ground pin for the PLL core
39	VDDCOR	PWR	Power pin for the PLL core. 3.3V
43, 47	VDDLCPU	PWR	Power pin for the CPUCLKs. 2.5V
40, 44	GNDLCPU	PWR	Ground pin for the CPUCLKs
41, 42, 45, 46	CPUCLK[0:3]	OUT	Host bus clock output at 2.5V. 133MHz or 100MHz depending on the state of the SEL 133/100MHz.
48	GNDLCPU/2	PWR	Ground pin for the CPU/2 clocks.
49, 50	CPU/2[0:1]	OUT	2.5V clock outputs at 1/2 CPU frequency. 66MHz or 50MHz depending on the state of the SEL 133/100# input pin.
51	VDDLCPU/2	PWR	Power pin for the CPU/2 clocks. 2.5V
52	GNDLIOAPIC	PWR	Ground pin for the IOAPIC outputs.
53, 54, 55	IOAPIC[0:2]	OUT	IOAPIC clocks at 2.5V. Synchronous with CPUCLKs but fixed at 16.67MHz.
56	VDDLIOAPIC	PWR	Power pin for the IOAPIC outputs. 2.5V.



**Frequency Select:**

SEL 133/100-#	SEL1	SEL0	CPU MHz	CPU/2 MHz	3V66 MHz	PCI MHz	48 MHz	REF MHz	IOAPIC MHz	Comments
0	0	0	Hi-Z	Hi-Z	Hi-Z	Hi-Z	Hi-Z	Hi-Z	Hi-Z	Tri-state
0	0	1	N/A	N/A	N/A	N/A	N/A	N/A	N/A	Reserved
0	1	0	100.00	50.00	66.67	33.33	Hi-Z	14.318	16.67	48MHz PLL disabled
0	1	1	100.00	50.00	66.67	33.33	48	14.318	16.67	
1	0	0	TCLK/2	TCLK/4	TCLK/4	TCLK/8	TCLK/2	TCLK	TCLK/16	Test mode (1)
1	0	1	N/A	N/A	N/A	N/A	N/A	N/A	N/A	Reserved
1	1	0	133.32	66.67	66.67	33.33	Hi-Z	14.318	16.67	
1	1	1	133.32	66.67	66.67	33.33	48	14.318	16.67	

**Note:**

1. TCLK is a test clock driven on the x1 input during test mode.

**Power Management Features:**

CPU_STOP#	PD#	PCI_STOP#	CPUCLK	CPU/2	IOAPIC	3V66	PCI	PCI_F	REF 48MHz	Osc	VCOs
X	0	X	LOW	LOW	LOW	LOW	LOW	LOW	LOW	OFF	OFF
0	1	0	LOW	ON	ON	LOW	LOW	ON	ON	ON	ON
0	1	1	LOW	ON	ON	LOW	ON	ON	ON	ON	ON
1	1	0	ON	ON	ON	ON	LOW	ON	ON	ON	ON
1	1	1	ON	ON	ON	ON	ON	ON	ON	ON	ON

**Note:**

1. LOW means outputs held static LOW as per latency requirement next page.
2. On means active.
3. PD# pulled Low, impacts all outputs including REF and 48 MHz outputs.
4. All 3V66 as well as all CPU clocks should stop cleanly when CPU\_STOP# is pulled LOW.
5. CPU/2, IOAPIC, REF, 48 MHz signals are not controlled by the CPU\_STOP# functionality and are enabled all in all conditions except PD# = LOW



## Power Management Requirements:

Signal	Signal State	Latency
		No. of rising edges of PCICLK
CPU_STOP	0 (disabled)	1
	1 (enabled)	1
PCI_STOP#	0 (disabled)	1
	1 (enabled)	1
PD#	1 (normal operation)	3mS
	0 (power down)	2max.

### Note:

1. Clock on/off latency is defined in the number of rising edges of free running PCICLKs between the clock disable goes low/high to the first valid clock comes out of the device.
2. Power up latency is when PWR\_DWN# goes inactive (high to when the first valid clocks are driven from the device).

## CPU\_STOP# Timing Diagram

CPU\_STOP# is an asynchronous input to the clock synthesizer. It is used to turn off the CPU and 3V66 clocks for low power operation. CPU\_STOP# is asserted asynchronously by the external clock control logic with the rising edge of free running PCI clock (and hence CPU clock) and must be internally synchronized to the external output. All other clocks will continue to run while the CPU clocks are disabled. The CPU clocks must always be stopped in a low state and started in such a manner as to guarantee that the high pulse width is a full pulse. **ONLY one rising edge of PCICLK\_F is allowed** after the clock control logic switched for both the CPU and 3V66 outputs to become enabled/disabled.

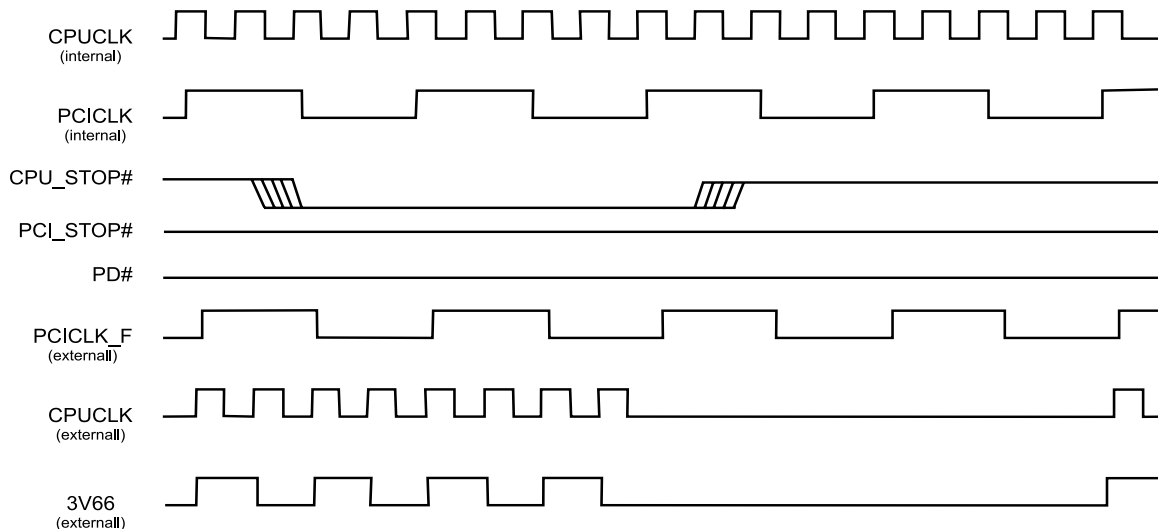

### Notes:

1. All timing is referenced to the internal CPUCLK.
2. The internal label means inside the chip and is a reference only. This in fact may not be the way that the control is designed.
3. CPU\_STOP# signal is an input signal that must be made synchronous to free running PCICLK\_F
4. 3V66 clocks also stop/start before
5. PD# and PCI\_STOP# are shown in a high state.
6. Diagrams shown with respect to 133MHz. Similar operation when CPU is 100MHz



## PCI\_STOP# Timing Diagram

PCI\_STOP# is an input to the clock synthesizer and must be made synchronous to the clock driver PCICLK\_F output. It is used to turn off the PCI clocks for low power operation. PCI clocks are required to be stopped in a low state and started such that a full high pulse width is guaranteed. **ONLY one rising edge of PCICLK\_F is allowed** after the clock control logic switched for the PCI outputs to become enabled/disabled.

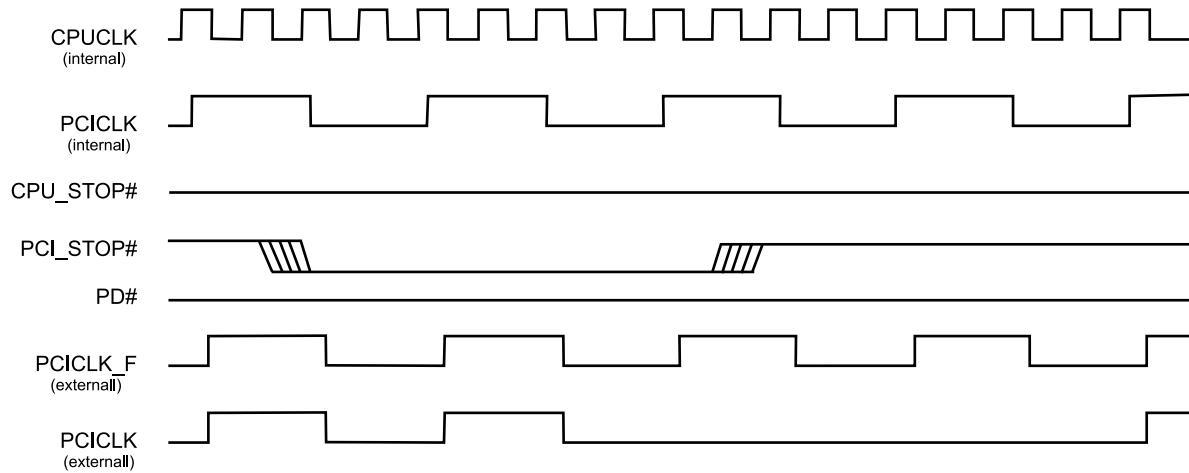

### Notes:

1. All timing is referenced to CPUCLK.
2. PCI\_STOP# signal is an input signal which must be made synchronous to PCICLK\_F output.
3. Internal means inside the chip.
4. All other clocks continue to run undisturbed.
5. PD# and CPU\_STOP# are shown in a high state.
6. Diagrams shown with respect to 133MHz. Similar operation when CPU is 100MHz.



## PD# Timing Diagram

The power down selection is used to put the part into a very low power state without turning off the power to the part. PD# is an asynchronous active low input. This signal needs to be synchronized internal to the device prior to powering down the clock synthesizer.

Internal clocks are not running after the device is put in power down. When PD# is active low all clocks need to be driven to a low value and held prior to turning off the VCOs and crystal. The power up latency needs to be less than 3 mS. The power down latency should be as short as possible but conforming to the sequence requirements shown below. PCI\_STOP# and CPU\_STOP# are considered to be don't cares during the power down operations. The REF and 48MHz clocks are expected to be stopped in the LOW state as soon as possible. Due to the state of the internal logic, stopping and holding the REF clock outputs in the LOW state may require more than one clock cycle to complete.

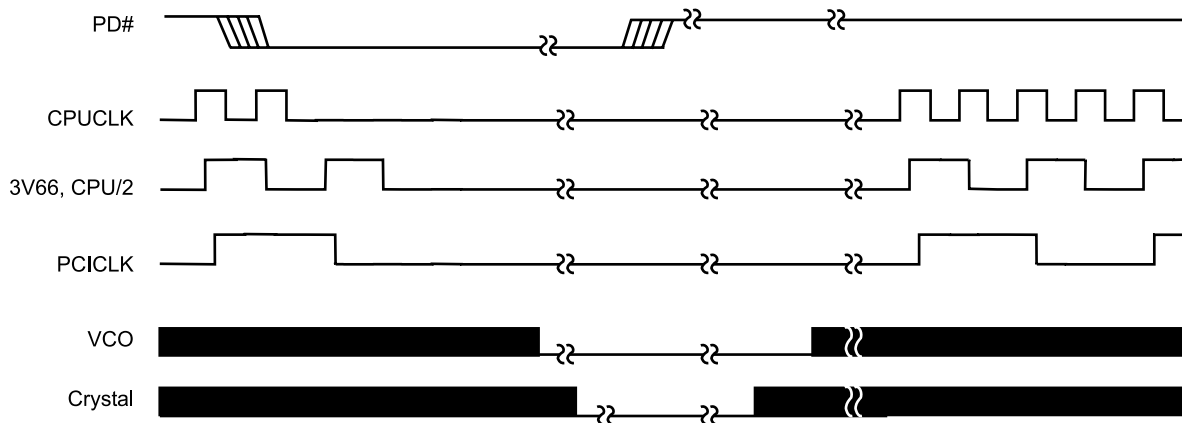

### Notes:

1. All timing is referenced to the Internal CPUCLK (defined as inside the ICS9250 device).
2. As shown, the outputs Stop Low on the next falling edge after PD# goes low.
3. PD# is an asynchronous input and metastable conditions may exist. This signal is synchronized inside this part.
4. The shaded sections on the VCO and the Crystal signals indicate an active clock.
5. Diagrams shown with respect to 133MHz. Similar operation when CPU is 100MHz.



### Absolute Maximum Ratings

- Supply Voltage . . . . . 7.0 V
- Logic Inputs . . . . . GND–0.5 V to V<sub>DD</sub>+0.5 V
- Ambient Operating Temperature . . . . . 0°C to +70°C
- Storage Temperature . . . . . –65°C to +150°C

Stresses above those listed under *Absolute Maximum Ratings* may cause permanent damage to the device. These ratings are stress specifications only and functional operation of the device at these or any other conditions above those listed in the operational sections of the specifications is not implied. Exposure to absolute maximum rating conditions for extended periods may affect product reliability.

### Group Offset

Group	Offset	Measurement Loads	Measure Points
CPU to 3V66	0.0-1.5ns CPU leads	CPU @ 20pF, 3V66 @ 30pF	CPU @ 1.25V, 3V66 @ 1.5V
3V66 to PCI	1.5-4.0ns 3V66 leads	3V66 @ 30pF, PCI @ 30pF	3V66 @ 1.5V, PCI @ 1.5V
CPU to IOAPIC	1.5-4.0ns CPU leads	CPU @ 20pF, IOAPIC @ 20pF	CPU @ 1.25V, IOAPIC @ 1.5V

Note: 1. All offsets are to be measured at rising edges.

### Electrical Characteristics - Input/Supply/Common Output Parameters

T<sub>A</sub> = 0 - 70° C; Supply Voltage V<sub>DD</sub> = 3.3 V +/-5%, V<sub>DDL</sub> = 2.5 V +/-5% (unless otherwise stated)

PARAMETER	SYMBOL	CONDITIONS	MIN	TYP	MAX	UNITS
Input High Voltage	V <sub>IH</sub>		2		V <sub>DD</sub> +0.3	V
Input Low Voltage	V <sub>IL</sub>		V <sub>SS</sub> -0.3		0.8	V
Input High Current	I <sub>IH</sub>	V <sub>IN</sub> = V <sub>DD</sub>		0.1	5	µA
Input Low Current	I <sub>IL1</sub>	V <sub>IN</sub> = 0 V; Inputs with no pull-up resistors	-5	2.0		µA
Input Low Current	I <sub>IL2</sub>	V <sub>IN</sub> = 0 V; Inputs with pull-up resistors	-200	-100		µA
Operating Supply Current	I <sub>DD3.3OP100</sub>	Select @ 100MHz; Max discrete cap loads		68	180	mA
	I <sub>DD3.3OP133</sub>	Select @ 133MHz; Max discrete cap loads		80		
Power Down Supply Current	I <sub>DD3.3PD</sub>	C <sub>L</sub> = 0 pF; PWRDWN# = 0		62	200	uA
Input frequency	F <sub>i</sub>	V <sub>DD</sub> = 3.3 V	12	14.318	16	MHz
Input Capacitance <sup>1</sup>	C <sub>IN</sub>	Logic Inputs			5	pF
	C <sub>INX</sub>	X1 & X2 pins	27	36	45	pF
Transition Time <sup>1</sup>	T <sub>Trans</sub>	To 1st crossing of target Freq.			3	ms
Settling Time <sup>1</sup>	T <sub>S</sub>	From 1st crossing to 1% target Freq.		1		ms
Clk Stabilization <sup>1</sup>	T <sub>Stab</sub>	From V <sub>DD</sub> = 3.3 V to 1% target Freq.			3	ms

<sup>1</sup>Guaranteed by design, not 100% tested in production.

### Electrical Characteristics - Input/Supply/Common Output Parameters

T<sub>A</sub> = 0 - 70° C; Supply Voltage V<sub>DD</sub> = 3.3 V +/-5%, V<sub>DDL</sub> = 2.5 V +/-5% (unless otherwise stated)

PARAMETER	SYMBOL	CONDITIONS	MIN	TYP	MAX	UNITS
Operating Supply Current	I <sub>DD2.5OP66</sub>	Select @ 100MHz; Max discrete cap loads		19	25	mA
	I <sub>DD2.5OP100</sub>	Select @ 133MHz; Max discrete cap loads		22		

<sup>1</sup>Guaranteed by design, not 100% tested in production.



## Electrical Characteristics - CPUCLK

$T_A = 0 - 70^\circ\text{C}$ ;  $V_{DD} = 3.3\text{ V} \pm 5\%$ ,  $V_{DDL} = 2.5\text{ V} \pm 5\%$ ;  $C_L = 20\text{ pF}$  (unless otherwise stated)

PARAMETER	SYMBOL	CONDITIONS	MIN	TYP	MAX	UNITS
Output High Voltage	$V_{OH2B}$	$I_{OH} = -12.0\text{ mA}$	2	2.2		V
Output Low Voltage	$V_{OL2B}$	$I_{OL} = 12\text{ mA}$		0.3	0.4	V
Output High Current	$I_{OH2B}$	$V_{OH} = 1.7\text{ V}$		-35	-19	mA
Output Low Current	$I_{OL2B}$	$V_{OL} = 0.7\text{ V}$	19	27		mA
Rise Time	$t_{r2B}^1$	$V_{OL} = 0.4\text{ V}$ , $V_{OH} = 2.0\text{ V}$	0.4	1.2	1.6	ns
Fall Time	$t_{f2B}^1$	$V_{OH} = 2.0\text{ V}$ , $V_{OL} = 0.4\text{ V}$	0.4	1.25	1.6	ns
Duty Cycle	$d_{t2B}^1$	$V_T = 1.25\text{ V}$	45	48	55	%
Skew	$t_{sk2B}^1$	$V_T = 1.25\text{ V}$		80	175	ps
Jitter, One Sigma	$t_{j1\sigma2B}^1$	$V_T = 1.25\text{ V}$		20	150	ps
Jitter, Absolute	$t_{jabs2B}^1$	$V_T = 1.25\text{ V}$	-250	61	+250	ps
Jitter, Cycle-to-cycle	$t_{j\text{cyc-cyc}2B}^1$	$V_T = 1.25\text{ V}$		150	250	ps

<sup>1</sup>Guaranteed by design, not 100% tested in production.

## Electrical Characteristics - CPU/2

$T_A = 0 - 70^\circ\text{C}$ ;  $V_{DD} = 3.3\text{ V} \pm 5\%$ ,  $V_{DDL} = 2.5\text{ V} \pm 5\%$ ;  $C_L = 20\text{ pF}$  (unless otherwise stated)

PARAMETER	SYMBOL	CONDITIONS	MIN	TYP	MAX	UNITS
Output High Voltage	$V_{OH2B}$	$I_{OH} = -12.0\text{ mA}$	2	2.3		V
Output Low Voltage	$V_{OL2B}$	$I_{OL} = 12\text{ mA}$		0.3	0.4	V
Output High Current	$I_{OH2B}$	$V_{OH} = 1.7\text{ V}$		-35	-19	mA
Output Low Current	$I_{OL2B}$	$V_{OL} = 0.7\text{ V}$	19	27		mA
Rise Time	$t_{r2B}^1$	$V_{OL} = 0.4\text{ V}$ , $V_{OH} = 2.0\text{ V}$	0.4	1.1	1.6	ns
Fall Time	$t_{f2B}^1$	$V_{OH} = 2.0\text{ V}$ , $V_{OL} = 0.4\text{ V}$	0.4	1	1.6	ns
Duty Cycle	$d_{t2B}^1$	$V_T = 1.25\text{ V}$	45	48	55	%
Jitter, One Sigma	$t_{j1\sigma2B}^1$	$V_T = 1.25\text{ V}$		20	150	ps
Jitter, Absolute	$t_{jabs2B}^1$	$V_T = 1.25\text{ V}$	-250	70	+250	ps
Jitter, Cycle-to-cycle	$t_{j\text{cyc-cyc}2B}^1$	$V_T = 1.25\text{ V}$		100	250	ps

<sup>1</sup>Guaranteed by design, not 100% tested in production.





### Electrical Characteristics - 3V66

T<sub>A</sub> = 0 - 70° C; V<sub>DD</sub> = 3.3 V +/-5%, V<sub>DDL</sub> = 2.5 V +/-5%; C<sub>L</sub> = 30 pF

PARAMETER	SYMBOL	CONDITIONS	MIN	TYP	MAX	UNITS
Output High Voltage	V <sub>OH1</sub>	I <sub>OH</sub> = -11 mA	2.4	3.1		V
Output Low Voltage	V <sub>OL1</sub>	I <sub>OL</sub> = 9.4 mA		0.25	0.4	V
Output High Current	I <sub>OH1</sub>	V <sub>OH</sub> = 2.0 V		-60	-22	mA
Output Low Current	I <sub>OL1</sub>	V <sub>OL</sub> = 0.8 V	25	44		mA
Rise Time <sup>1</sup>	t <sub>rl</sub>	V <sub>OL</sub> = 0.4 V, V <sub>OH</sub> = 2.4 V	0.5	1.6	2	ns
Fall Time <sup>1</sup>	t <sub>fl</sub>	V <sub>OH</sub> = 2.4 V, V <sub>OL</sub> = 0.4 V	0.5	1.3	2	ns
Duty Cycle <sup>1</sup>	d <sub>t1</sub>	V <sub>T</sub> = 1.5 V	45	48	55	%
Skew <sup>1</sup>	t <sub>sk1</sub>	V <sub>T</sub> = 1.5 V		120	175	ps
Jitter, One Sigma <sup>1</sup>	t <sub>j1σ1</sub>	V <sub>T</sub> = 1.5 V		43	150	ps
Jitter, Absolute <sup>1</sup>	t <sub>jabs1</sub>	V <sub>T</sub> = 1.5 V	-250	100	250	ps
Jitter, Cycle-to-cycle <sup>1</sup>	t <sub>jeyc-cycl1</sub>	V <sub>T</sub> = 1.5 V		150	500	ps

<sup>1</sup>Guaranteed by design, not 100% tested in production.

### Electrical Characteristics - PCICLK

T<sub>A</sub> = 0 - 70° C; V<sub>DD</sub> = 3.3 V +/-5%, V<sub>DDL</sub> = 2.5 V +/-5%; C<sub>L</sub> = 60 pF for PCI0 & PCI1, CL = 30 pF for other PCIs

PARAMETER	SYMBOL	CONDITIONS	MIN	TYP	MAX	UNITS
Output High Voltage	V <sub>OH1</sub>	I <sub>OH</sub> = -11 mA	2.4	3.1		V
Output Low Voltage	V <sub>OL1</sub>	I <sub>OL</sub> = 9.4 mA		0.2	0.4	V
Output High Current	I <sub>OH1</sub>	V <sub>OH</sub> = 2.0 V		-60	-22	mA
Output Low Current	I <sub>OL1</sub>	V <sub>OL</sub> = 0.8 V	25	45		mA
Rise Time <sup>1</sup>	t <sub>rl</sub>	V <sub>OL</sub> = 0.4 V, V <sub>OH</sub> = 2.4 V	0.5	1.7	2	ns
Fall Time <sup>1</sup>	t <sub>fl</sub>	V <sub>OH</sub> = 2.4 V, V <sub>OL</sub> = 0.4 V	0.5	1.6	2	ns
Duty Cycle <sup>1</sup>	d <sub>t1</sub>	V <sub>T</sub> = 1.5 V	45	50	55	%
Skew <sup>1</sup>	t <sub>sk1</sub>	V <sub>T</sub> = 1.5 V		360	500	ps
Jitter, One Sigma <sup>1</sup>	t <sub>j1σ1</sub>	V <sub>T</sub> = 1.5 V		18	150	ps
Jitter, Absolute <sup>1</sup>	t <sub>jabs1</sub>	V <sub>T</sub> = 1.5 V	-250	80	250	ps
Jitter, Cycle-to-cycle <sup>1</sup>	t <sub>jeyc-cycl1</sub>	V <sub>T</sub> = 1.5 V		155	500	ps

<sup>1</sup>Guaranteed by design, not 100% tested in production.



## Electrical Characteristics - 48MHz, REF

$T_A = 0 - 70^\circ\text{C}$ ;  $V_{DD} = 3.3\text{ V} \pm 5\%$ ,  $V_{DDL} = 2.5\text{ V} \pm 5\%$ ;  $C_L = 20\text{ pF}$  (unless otherwise stated)

PARAMETER	SYMBOL	CONDITIONS	MIN	TYP	MAX	UNITS
Output High Voltage	$V_{OH5}$	$I_{OH} = -12\text{ mA}$	2.6	2.9		V
Output Low Voltage	$V_{OL5}$	$I_{OL} = 9\text{ mA}$		0.3	0.4	V
Output High Current	$I_{OH5}$	$V_{OH} = 2.0\text{ V}$		-35	-22	mA
Output Low Current	$I_{OL5}$	$V_{OL} = 0.8\text{ V}$	17	23		mA
Rise Time <sup>1</sup>	$t_{r5}$	$V_{OL} = 0.4\text{ V}$ , $V_{OH} = 2.4\text{ V}$ , 48MHz		2	4	ns
Fall Time <sup>1</sup>	$t_{f5}$	$V_{OH} = 2.4\text{ V}$ , $V_{OL} = 0.4\text{ V}$ , 48MHz		2	4	ns
Duty Cycle <sup>1</sup>	$d_{t5}$	$V_T = 1.5\text{ V}$ , 48MHz	45	50	55	%
Rise Time <sup>1</sup>	$t_{r5}$	$V_{OL} = 0.4\text{ V}$ , $V_{OH} = 2.4\text{ V}$ , REF		2.2	4	ns
Fall Time <sup>1</sup>	$t_{f5}$	$V_{OH} = 2.4\text{ V}$ , $V_{OL} = 0.4\text{ V}$ , REF		1.9	4	ns
Duty Cycle <sup>1</sup>	$d_{t5}$	$V_T = 1.5\text{ V}$ , REF	45	52	55	%
Jitter, Cycle-to-cycle <sup>1</sup>	$t_{j\text{cyc-cyc}5}$	$V_T = 1.5\text{ V}$ , 48MHz		200	500	ps
Jitter, Cycle-to-cycle <sup>1</sup>	$t_{j\text{cyc-cyc}5}$	$V_T = 1.5\text{ V}$ , REF		800	1000	ps

<sup>1</sup>Guaranteed by design, not 100% tested in production.

## Electrical Characteristics - IOAPIC

$T_A = 0 - 70^\circ\text{C}$ ;  $V_{DD} = 3.3\text{ V} \pm 5\%$ ,  $V_{DDL} = 2.5\text{ V} \pm 5\%$ ;  $C_L = 20\text{ pF}$  (unless otherwise stated)

PARAMETER	SYMBOL	CONDITIONS	MIN	TYP	MAX	UNITS
Output High Voltage	$V_{OH4B}$	$I_{OH} = -12\text{ mA}$	2	2.23		V
Output Low Voltage	$V_{OL4B}$	$I_{OL} = 12\text{ mA}$		0.3	0.4	V
Output High Current	$I_{OH4B}$	$V_{OH} = 1.7\text{ V}$		-36	-16	mA
Output Low Current	$I_{OL4B}$	$V_{OL} = 0.7\text{ V}$	19	26		mA
Rise Time <sup>1</sup>	$T_{r4B}$	$V_{OL} = 0.4\text{ V}$ , $V_{OH} = 2.0\text{ V}$	0.4	1.3	1.6	ns
Fall Time <sup>1</sup>	$T_{f4B}$	$V_{OH} = 2.0\text{ V}$ , $V_{OL} = 0.4\text{ V}$	0.4	1.25	1.6	ns
Duty Cycle <sup>1</sup>	$D_{t4B}$	$V_T = 1.25\text{ V}$	45	49	55	%
Jitter, One Sigma <sup>1</sup>	$T_{j1\sigma 4B}$	$V_T = 1.25\text{ V}$		14	150	ps
Jitter, Absolute <sup>1</sup>	$T_{j\text{abs}4B}$	$V_T = 1.25\text{ V}$	-250	65	250	ps
Jitter, Cycle-to-cycle <sup>1</sup>	$t_{j\text{cyc-cyc}4B}$	$V_T = 1.25\text{ V}$		87	500	ps

<sup>1</sup>Guaranteed by design, not 100% tested in production.



**General Layout Precautions:**

- 1) Use a ground plane on the top routing layer of the PCB in all areas not used by traces.
- 2) Make all power traces and ground traces as wide as the via pad for lower inductance.

**Notes:**

- ① All clock outputs should have provisions for a 15pf capacitor between the clock output and series terminating resistor. Not shown in all places to improve readability of diagram.
- ② Optional crystal load capacitors are recommended. They should be included in the layout but not inserted unless needed.

**Connections to VDD:**

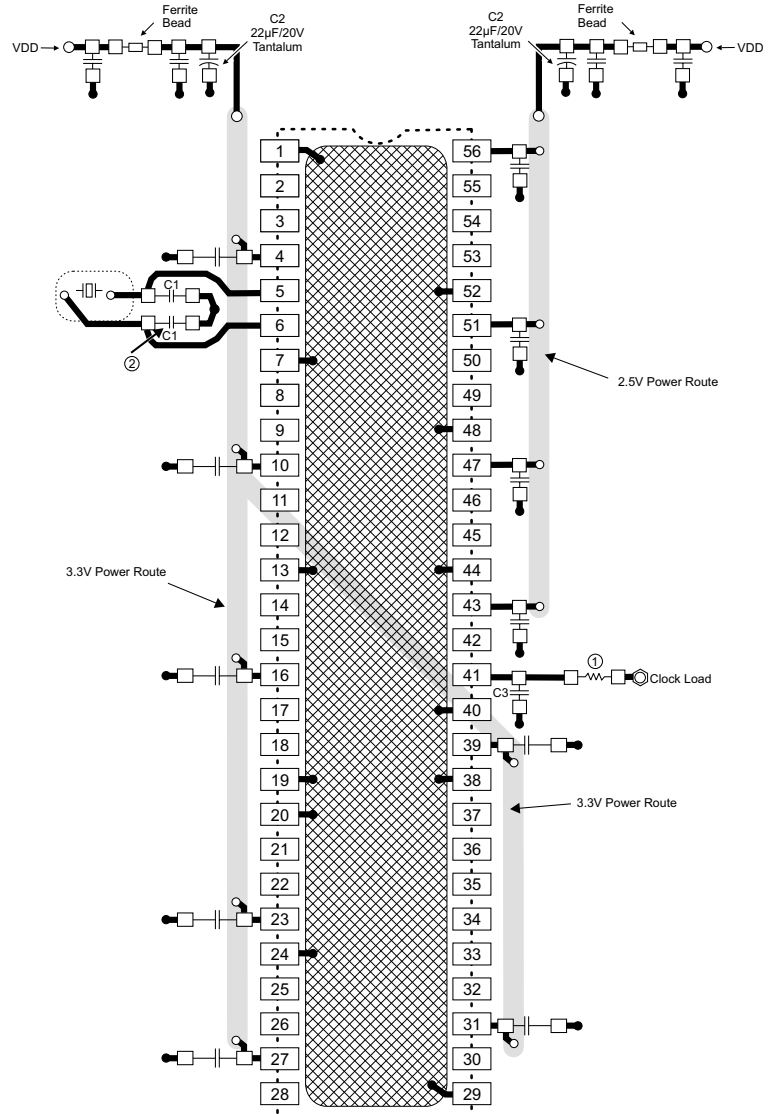
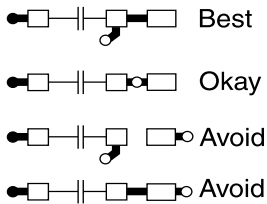

- = Routed Power
- ▧ = Ground Connection Key (component side copper)
- = Ground Plane Connection
- = Power Route Connection
- = Solder Pads
- ⊗ = Clock Load

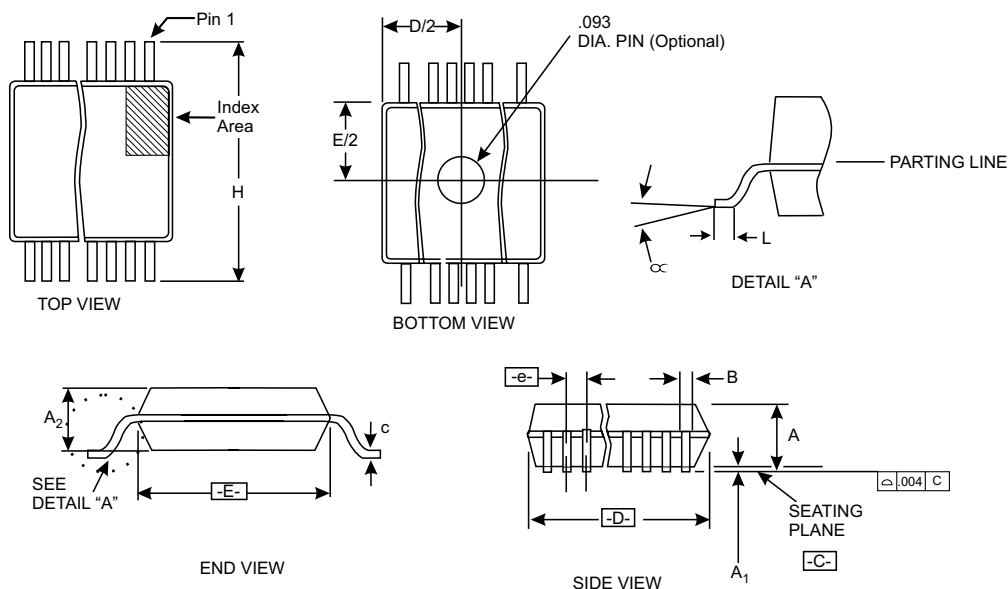

SYMBOL	COMMON DIMENSIONS			VARIATIONS	D			N
	MIN.	NOM.	MAX.		MIN.	NOM.	MAX.	
A	.095	.102	.110	AD	.720	.725	.730	56
A1	.008	.012	.016	"For current dimensional specifications, see JEDEC 95."  Dimensions in inches				
A2	.087	.090	.094					
B	.008	-	.0135					
c	.005	-	.010					
D	See Variations							
E	.291	.295	.299					
e	0.025 BSC							
H	.395	-	.420					
h	.010	.013	.016					
L	.020	-	.040					
N	See Variations							
∞	0°	-	8°					

## 56 Pin 300 mil SSOP Package

### Ordering Information

ICS9250yF-09-T

Example:

ICS XXXX y F - PPP - T

- Prefix  
ICS, AV = Standard Device
- Device Type (consists of 3 or 4 digit numbers)
- Revision Designator (will not correlate with datasheet revision)
- Package Type  
F=SSOP
- Pattern Number (2 or 3 digit number for parts with ROM code patterns)
- Designation for tape and reel packaging