

Data Sheet

- ITEM : ESD FILTER

-PART NO : ICVE10184E070R100FR

1. Scope

- This specification applies to R-varistor for EMI & ESD devices.
- The specification can be modified by documentary agreement between design engineers and customers.

2. Features

- 4 EMI filter lines per device.
- Multilayer chip EMI suppression filter utilizing π -type circuit.
- Very thin (max. 0.50t) and low space consuming(1.6X0.8mm²) size.
- Steep attenuation characteristic plot, Highly effective noise suppression.
- Covers a wide range of frequencies.
- No asymmetrical degradation.
- Simpler fabricating process than diode-type filters.
- Soldering of plating type terminations guarantee high physical and electrical reliability.

3. Applications

- Where EMI filtering in ESD sensitive equipment is required.
- Mobile Phones
- Computers and Printers
- Communication Systems
- Internet Appliances
- PDAs
- Laptop Computers

4. Configuration and Dimensions

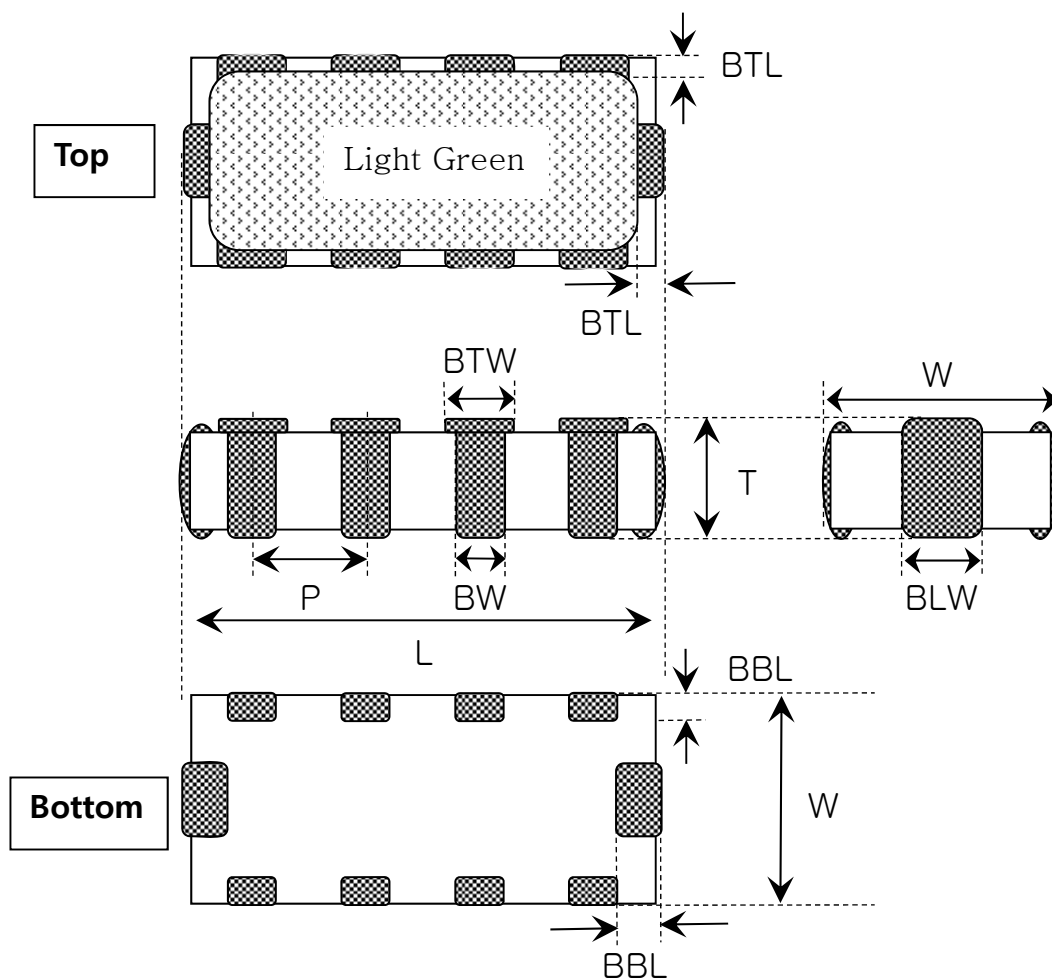

Unit : mm

Symbol	Dimensions	Symbol	Dimensions
L	1.60±0.10	BTL	0.08±0.03
W	0.80±0.10	BBL	0.10±0.03
T	0.50max	BTW	0.22±0.05
P	0.40±0.05	BLW	0.23±0.05
BW	0.20±0.05		

5. Part Number Code

ICVE 10 18 4E 070 R100 F R

① ② ③ ④ ⑤ ⑥ ⑦ ⑧

① SERIES NAME

CODE	PRODUCT NAME
ICVE	EMI Filter Array chip Varistor

② SIZE DESIGNATOR

CODE	SIZE(mm)
10	1.6 × 0.8

③ WORKING VOLTAGE

CODE	VOLTAGE(VDC)
05	5.6
09	9
14	14
18	18

④ NUMBER OF ELEMENT

CODE	NUMBER OF ELEMENT
4E	4 Element

⑤ C line CAPACITANCE

CODE	CAPACITANCE@1MHz(pF)
050	5
070	7.5
150	15
250	25
300	30
500	50

⑥ RESISTANCE

CODE	RESISTANCE(Ω)
R100	10
R500	50
R101	100
R201	200
R401	400

⑦ TERMINATION

CODE	TYPE
F	Electroplate (Pb-free)

⑧ PACKING TYPE

CODE	TYPE
R	Tape & Reel pack

6. Nominal Specifications

Chip Size	ICT Part Number	Leakage Current	Varistor Voltage	Clamping Voltage	Peak Current	Resistance	Capacitance
	symbol	I_L	V_B	V_C	I_{peak}	R	C line
	Units	Amp (max.)	volts	volts (typ.)	Amp (max.)	Ohm (max.)	pF (typ.)
	Test Condition	18V	1mA DC	8/20 μ s @ 1A	8/20 μ s	25°C	0.5Vrms @1MHz
1608	ICVE10184E070R100	<20 μ A	55-85	130	6	10(\pm 40%)	7.5(\pm 30%)

ICT Part Number	Frequency(MHz)	Attenuation(dB)	Cut-off Frequency(MHz)
ICVE10184E070R100	2,800-3,500	minimum	Typical(-3dB)
		-20	430

■ TERMINOLOGY

- I_L : Maximum steady state DC operating voltage the varistor can maintain and not exceed 20 μ A leakage current.
- V_B : Voltage across the device measured at 1mA DC current
- V_C : Maximum peak voltage across the varistor measured at a specified pulse and waveform
Pulse Current : 1A , Waveform : 8/20 μ s
- I_{peak} : Maximum peak current which may be applied with the specified waveform without device failure
- C : Device capacitance measured with zero volt bias 0.5Vrms and 1MHz

7. LAND PATTERN

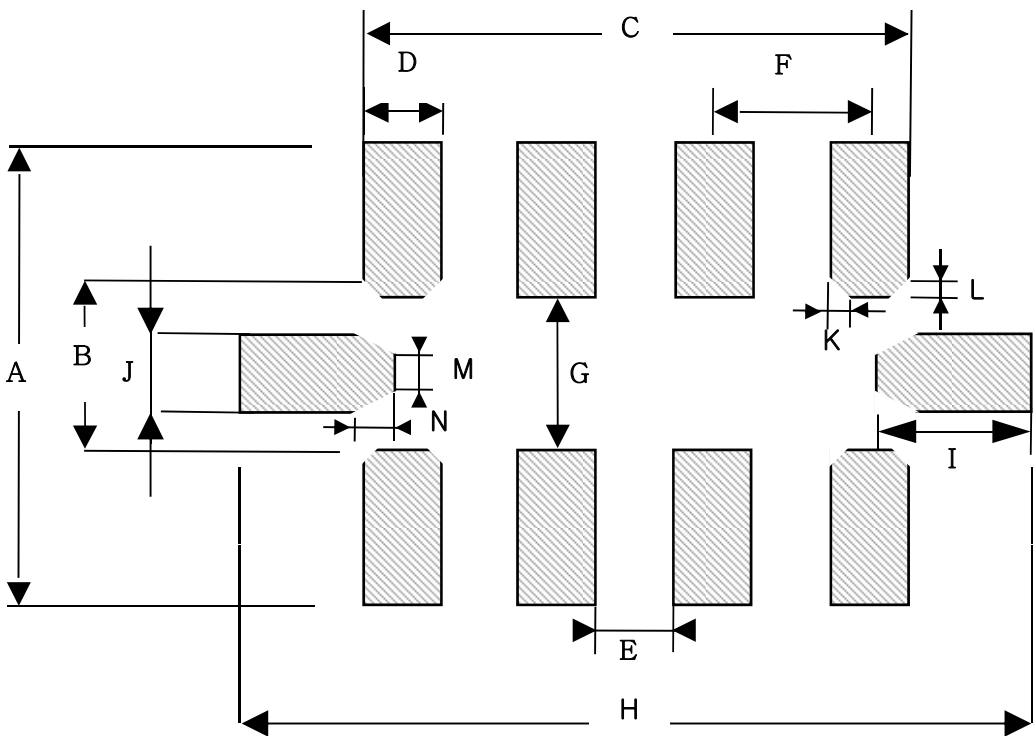

Unit : mm

Size	A	B	C	D	E	F	G	H
	1.20	0.50	1.40	0.20	0.20	0.40	0.40	2.04
	I	J	K	L	M	N		
	0.40	0.17	0.05	0.05	0.07	0.10		

ITEM	P/N	Page
ESD FILTER	ICVE10184E070R100FR	7

8. ELECTRICAL SCHEMATIC

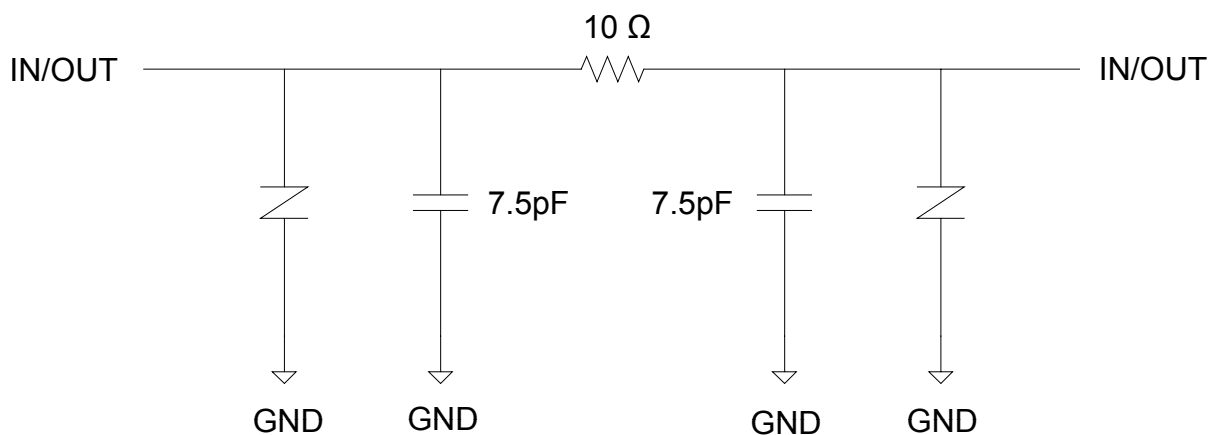
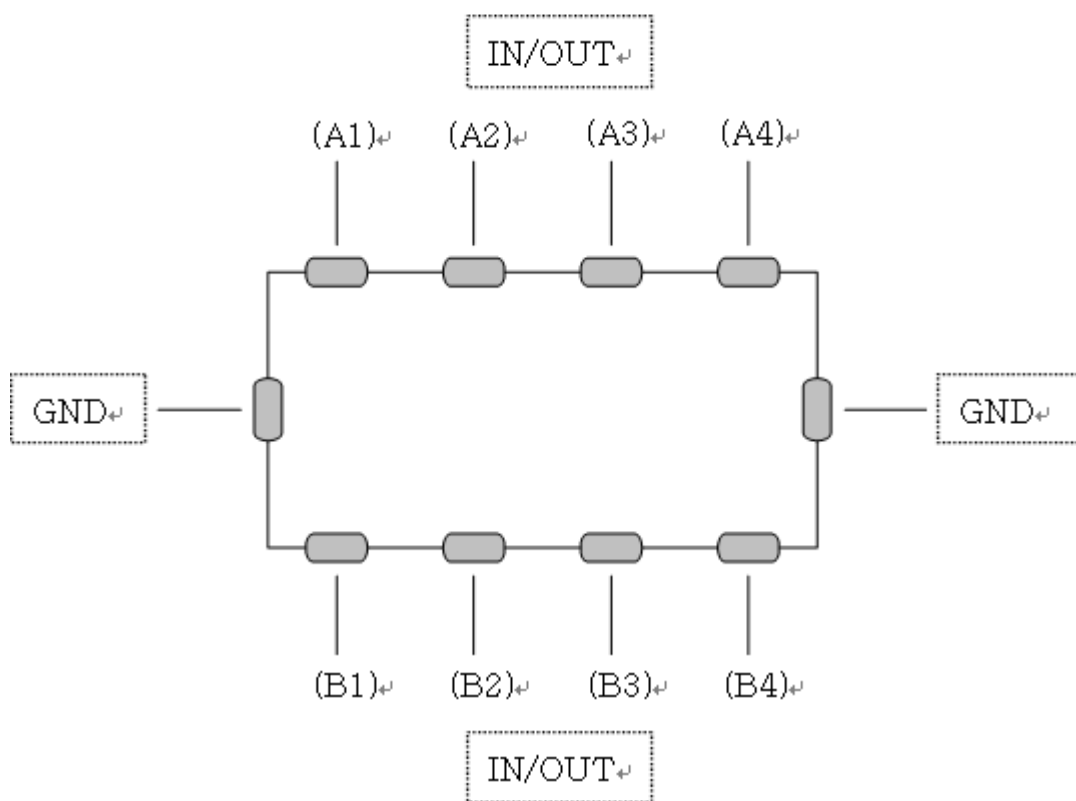

ITEM	P/N	Page
ESD FILTER	ICVE10184E070R100FR	8

9. Typical Characteristics

Filter Performance($T_A=25^\circ\text{C}$, DC Bias=0V, 50ohm Environment)

1) A1-B1, A2-B2, A3-B3, A4-B4

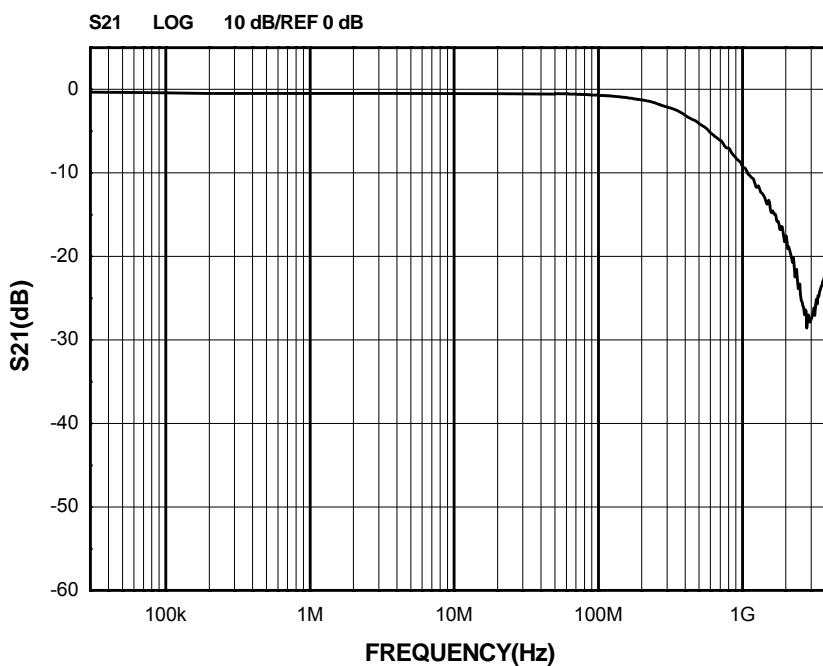

2) Cross talking(A1-B2, A2-B3, A3-B4)

