

IFX30081SJV

50mA, Adjustable Linear Voltage Regulator with Ultra Low Quiescent Current

Data Sheet

Rev. 1.0, 2015-02-04

Standard Power



1 Overview

Features

- Ultra Low Current Consumption of typ. 5 μ A
- Wide Input Voltage Range of 2.75 V to 42 V
- Output Current Capability up to 50 mA
- Shutdown Current less than 1 μ A
- Low Drop Out Voltage of typ. 100mV @ 50mA
- Output Current Limit Protection
- Overtemperature Shutdown
- Enable Feature
- Available in PG-DSO-8
- Wide Temperature Range $-40^{\circ}\text{C} \leq T_j \leq 125^{\circ}\text{C}$
- Green Product (RoHS compliant)

Applications

- Battery Operated Systems
- Sensor Supplies
- Smoke and Fire Detectors

The IFX30081SJV is not qualified and manufactured according to the requirements of Infineon Technologies with regards to automotive and/or transportation applications. For automotive applications please refer to the Infineon TLx (TLE, TLS, TLF...) voltage regulator products.

Description

The IFX30081SJV is a wide input voltage, low drop out voltage and ultra low quiescent current linear voltage regulator.

With a wide input voltage range of 2.75 V to 42 V and ultra low current consumption of only 5 μ A this regulator is perfectly suitable for battery operated systems as well as supplies for sensors.

The IFX30081SJV is available with an adjustable output voltage with an accuracy of 2 % and maximum output current up to 50 mA.

The regulation concept implemented in the IFX30081SJV combines fast regulation and very good stability while requiring only a small ceramic capacitor of 1 μ F at the output. Internal protection features like output current

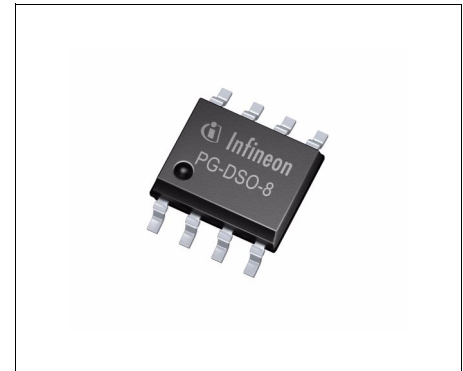

PG-DSO-8

Type	Package	Marking
IFX30081SJV	PG-DSO-8	30081SJV

limitation and overtemperature shutdown are implemented to protect the device against failures like output short circuit to GND, over-current and over-temperature. The device can be switched on and off by the Enable feature. When the device is switched off, the current consumption is less than 1 μA .

Choosing External Components

An input capacitor C_{IN} is recommended to compensate line influences. The output capacitor C_{OUT} is necessary for the stability of the regulating circuit. Stability is guaranteed at values $C_{\text{OUT}} \geq 1\mu\text{F}$ and an $\text{ESR} \leq 100\ \Omega$ within the whole operating range.

2 Block Diagram

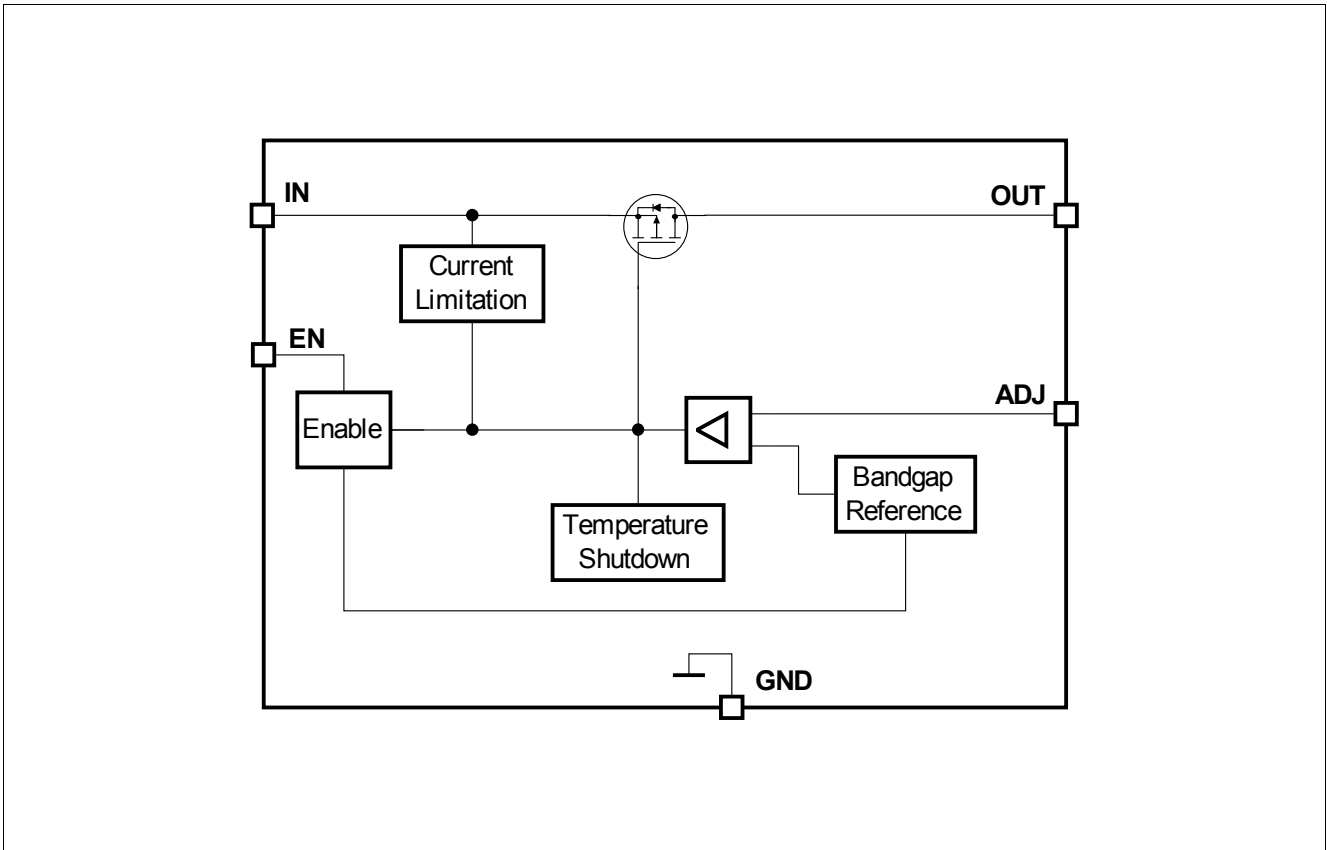

Figure 1 Block Diagram IFX30081SJV

3 Pin Configuration

3.1 Pin Assignment in PG-DSO-8 Package

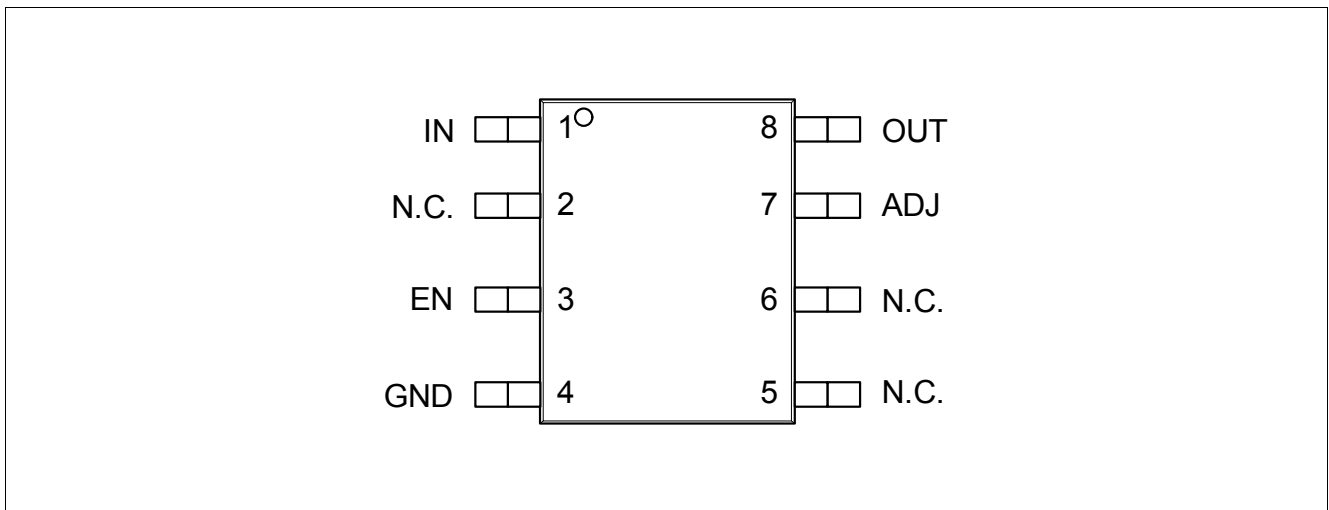

Figure 2 Pin Configuration IFX30081SJV in PG-DSO-8 package

3.2 Pin Definitions and Functions in PG-DSO-8 Package

Pin	Symbol	Function
1	IN	Input It is recommended to place a small ceramic capacitor (e.g. 100 nF), to GND, close to the IC terminals, in order to compensate line influences.
2	N.C.	Not Connected
3	EN	Enable Integrated pull-down resistor Enable the IC with high level input signal. Disable the IC with low level input signal.
4	GND	Ground
5	N.C.	Not Connected
6	N.C.	Not Connected
7	ADJ	Voltage Adjustment Connect an external voltage divider to determine the output voltage.
8	OUT	Output Connect an output capacitor C_{OUT} to GND close to the IC's terminals, respecting the values specified for its capacitance and ESR in Table 2 "Functional Range" on Page 7 .

4 General Product Characteristics

4.1 Absolute Maximum Ratings

Table 1 Absolute Maximum Ratings¹⁾

$T_j = -40^{\circ}\text{C}$ to $+125^{\circ}\text{C}$; all voltages with respect to ground, positive current flowing into pin (unless otherwise specified)

Parameter	Symbol	Values			Unit	Note / Test Condition	Number
		Min.	Typ.	Max.			
Voltage Input, Enable EN							
Voltage	V_{IN}, V_{EN}	-0.3	–	45	V	–	P_4.1.1
Voltage Output OUT, Voltage Adjustment ADJ							
Voltage	V_{OUT}	-0.3	–	45	V	–	P_4.1.2
Voltage	V_{ADJ}	-0.3	–	7	V	–	P_4.1.3
Temperatures							
Junction Temperature	T_j	-40	–	150	$^{\circ}\text{C}$	–	P_4.1.4
Storage Temperature	T_{stg}	-55	–	150	$^{\circ}\text{C}$	–	P_4.1.5
ESD Absorption							
ESD Absorption	$V_{ESD,HBM}$	-2	–	2	kV	HBM ²⁾	P_4.1.6
ESD Absorption	$V_{ESD,CDM}$	-750	–	750	V	CDM ³⁾ at all pins	P_4.1.7

1) Not subject to production testing, specified by design.

2) ESD susceptibility, HBM Test according to ANSI/ESDA/JEDEC JS-001 (1.5k Ω , 100pF).

3) ESD susceptibility, Charged Device Model "CDM" according to JEDEC JESD22-C101

Note:

1. Stresses above the ones listed here may cause permanent damage to the device. Exposure to absolute maximum rating conditions for extended periods may affect device reliability.
2. Integrated protection functions are designed to prevent IC destruction under fault conditions described in the data sheet. Fault conditions are considered as "outside" normal operating range. Protection functions are not designed for continuous repetitive operation.

4.2 Functional Range

Table 2 Functional Range

Parameter	Symbol	Values			Unit	Note / Test Condition	Number
		Min.	Typ.	Max.			
Input Voltage Range	V_{IN}	$V_{OUT,nom} + V_{dr}$	–	42	V	– ¹⁾	P_4.2.1
Extended Input Voltage Range	$V_{IN,ext}$	2.75	–	42	V	– ²⁾	P_4.2.2
Output Voltage Adjustable Range	V_{OUT}	1.2	–	$V_{IN} - V_{dr}$	V	$V_{IN} < 42V$	P_4.2.3
Output Capacitor	C_{OUT}	1	–	–	μF	– ³⁾	P_4.2.4
Output Capacitor's ESR	ESR(C_{OUT})	–	–	100	Ω	– ⁴⁾	P_4.2.5
Junction temperature	T_j	-40	–	125	°C	–	P_4.2.6

- 1) Output current is limited internally and depends on the input voltage, see Electrical Characteristics for more details.
- 2) Between min. value and $V_{OUT,nom} + V_{dr}$: $V_{OUT} = V_{IN} - V_{dr}$. Below min. value: V_{OUT} can drop down to 0 V.
- 3) The minimum output capacitance requirement is applicable for a worst case capacitance tolerance of 30%.
- 4) Relevant ESR value at $f = 10$ kHz.

Note: Within the functional or operating range, the IC operates as described in the circuit description. The electrical characteristics are specified within the conditions given in the Electrical Characteristics table.

4.3 Thermal Resistance

Note: This thermal data was generated in accordance with JEDEC JESD51 standards. For more information, go to www.jedec.org.

Table 3 Thermal Resistance

Parameter	Symbol	Values			Unit	Note / Test Condition	Number
		Min.	Typ.	Max.			
Junction to Case ¹⁾	R_{thJC}	–	40	–	K/W	–	P_4.3.1
Junction to Ambient ¹⁾	R_{thJA}	–	114	–	K/W	2s2p board ²⁾	P_4.3.2
Junction to Ambient ¹⁾	R_{thJA}	–	172	–	K/W	footprint only ³⁾	P_4.3.3
Junction to Ambient ¹⁾	R_{thJA}	–	139	–	K/W	300 mm ² heatsink area on PCB ³⁾	P_4.3.4
Junction to Ambient ¹⁾	R_{thJA}	–	133	–	K/W	600 mm ² heatsink area on PCB ³⁾	P_4.3.5

1) Not subject to production test, specified by design.

2) Specified R_{thJA} value is according to JEDEC JESD51-2,-5,-7 at natural convection on FR4 2s2p board; The product (Chip+Package) was simulated on a 76.2 x 114.3 x 1.5 mm³ board with two inner copper layers (2 x 70µm Cu, 2 x 35µm Cu). Wherever applicable a thermal via array under the exposed pad contacted the first inner copper layer.

3) Specified R_{thJA} value is according to JEDEC JESD51-3 at natural convection on FR4 1s0p board; The product (Chip+Package) was simulated on a 76.2 x 114.3 x 1.5 mm³ board with one inner copper layers (1 x 70µm Cu)

5 Block Description and Electrical Characteristics

5.1 Voltage Regulation

The output voltage V_{OUT} is divided by a resistor network. This fractional voltage is compared to an internal voltage reference and drives the pass transistor accordingly.

The control loop stability depends on the output capacitor C_{OUT} , the load current, the chip temperature and the internal circuit structure. To ensure stable operation, the output capacitor's capacitance and its equivalent series resistor ESR requirements given in **"Functional Range" on Page 7** have to be maintained. For details see the typical performance graph **"Output Capacitor Series Resistor ESR(C_{OUT}) versus Output Current I_{OUT} " on Page 12**. Since the output capacitor is used to buffer load steps, it should be sized according to the application's needs.

An input capacitor C_{IN} is not required for stability, but is recommended to compensate line fluctuations. An additional reverse polarity protection diode and a combination of several capacitors for filtering should be used, in case the input is connected to a battery. Connect the capacitors close to the regulator terminals.

In order to prevent overshoots during start-up, a smooth ramping up function is implemented. This ensures almost no overshoots during start-up, mostly independent from load and output capacitance.

Whenever the load current exceeds the specified limit, e.g. in case of a short circuit, the output current is limited and the output voltage decreases.

The overtemperature shutdown circuit prevents the IC from immediate destruction under fault conditions (e.g. output continuously short-circuit) by switching off the power stage. After the chip has cooled down, the regulator restarts. This oscillatory thermal behaviour causes the junction temperature to exceed the 150° C maximum and significantly reducing the IC's lifetime.

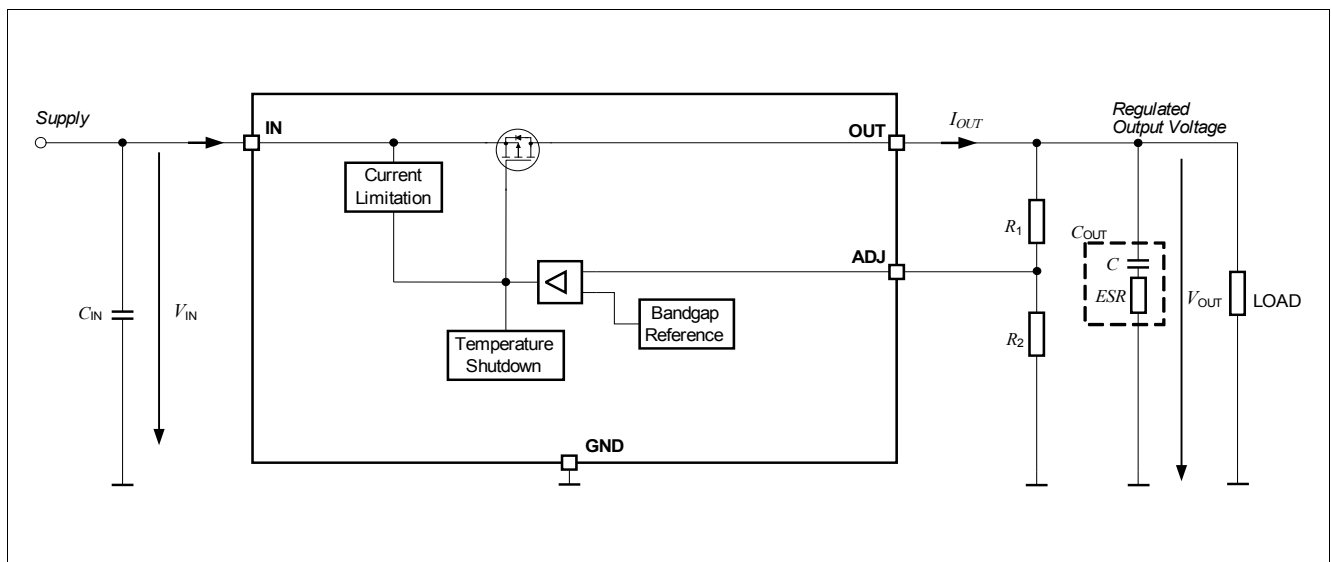

Figure 3 Block Diagram Voltage Regulation

Block Description and Electrical Characteristics

Table 4 Electrical Characteristics

$T_j = -40^\circ\text{C}$ to $+125^\circ\text{C}$, $V_{\text{IN}} = 13.5\text{ V}$, all voltages with respect to ground; positive current defined flowing out of pin (unless otherwise specified). Typical values are given at $T_j = 25^\circ\text{C}$, $V_{\text{IN}} = 13.5\text{ V}$

Parameter	Symbol	Values			Unit	Note / Test Condition	Number
		Min.	Typ.	Max.			
Output Voltage Precision ¹⁾	ΔV_{OUT}	-2	–	2	%	$50\ \mu\text{A} \leq I_{\text{OUT}} \leq 50\ \text{mA}$, $V_{\text{OUT}} + V_{\text{dr}} \leq V_{\text{IN}} \leq 28\ \text{V}$, $V_{\text{IN}} \geq 3\ \text{V}$, $R_2 \leq 250\ \text{k}\Omega$	P_5.1.2
Output Voltage Precision	ΔV_{OUT}	-2	–	2	%	$50\ \mu\text{A} \leq I_{\text{OUT}} \leq 25\ \text{mA}$, $V_{\text{OUT}} + V_{\text{dr}} \leq V_{\text{IN}} \leq 42\ \text{V}$, $V_{\text{IN}} \geq 3\ \text{V}$, $R_2 \leq 250\ \text{k}\Omega$	P_5.1.3
Output Current Limitation	$I_{\text{OUT,lim}}$	51	85	120	mA	$0\ \text{V} \leq V_{\text{OUT}} \leq$ $V_{\text{OUT,nom}} - 0.1\ \text{V}$	P_5.1.4
Line Regulation steady-state	$\Delta V_{\text{OUT,line}}$	–	1	20	mV	$I_{\text{OUT}} = 1\ \text{mA}$, $6\ \text{V} \leq V_{\text{IN}} \leq 32\ \text{V}$	P_5.1.6
Load Regulation steady-state	$\Delta V_{\text{OUT,load}}$	-20	-1	–	mV	$V_{\text{IN}} = 6\ \text{V}$, $50\ \mu\text{A} \leq I_{\text{OUT}} \leq 50\ \text{mA}$	P_5.1.7
Dropout Voltage ²⁾ $V_{\text{dr}} = V_{\text{IN}} - V_{\text{OUT}}$	V_{dr}	–	100	300	mV	$I_{\text{OUT}} = 50\ \text{mA}$, $V_{\text{IN}} = 5.4\ \text{V}$	P_5.1.11
Reference Voltage	V_{ref}	1.17	1.2	1.23	V	–	P_5.1.12
Output Voltage Adjustable Range	$V_{\text{OUT,Range}}$	1.2	–	$V_{\text{IN}} - V_{\text{dr}}$	V	$V_{\text{IN}} < 42\text{V}$	P_5.1.1
Ripple Rejection ³⁾	$PSRR$	–	60	–	dB	$I_{\text{OUT}} = 50\ \text{mA}$, $V_{\text{OUT}} = 1.2\ \text{V}$ $f_{\text{ripple}} = 100\ \text{Hz}$, $V_{\text{ripple}} = 0.5\ V_{\text{p-p}}$	P_5.1.13
Overtemperature Shutdown Threshold	$T_{j,\text{sd}}$	151	175	–	$^\circ\text{C}$	T_j increasing	P_5.1.14
Overtemperature Shutdown Threshold Hysteresis	$T_{j,\text{sdh}}$	–	10	–	K	T_j decreasing	P_5.1.15

1) Referring to the device tolerance only, the tolerance of the resistor divider can cause additional deviation. Parameter is tested with the ADJ pin directly connected to the output pin OUT.

2) Measured when the output voltage V_{OUT} has dropped 100mV from the nominal value obtained at $V_{\text{IN}} = 13.5\text{ V}$

3) Not subject to production test, guaranteed by design

5.2 Typical Performance Characteristics Voltage Regulation

Typical Performance Characteristics

Output Voltage V_{OUT} versus Junction Temperature T_j

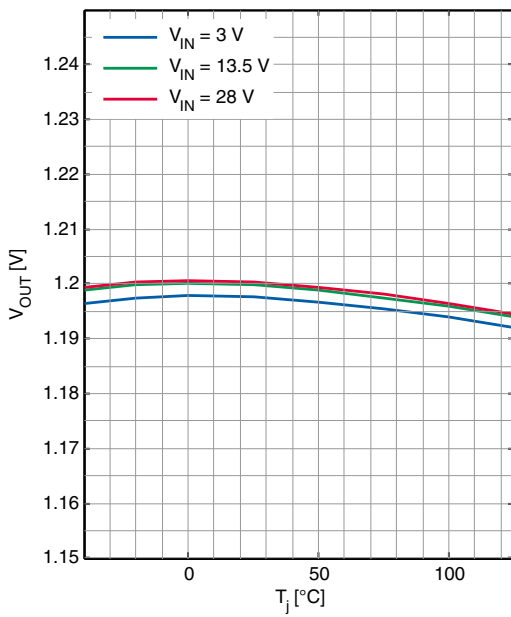

Output Voltage V_{OUT} versus Input Voltage V_{IN}

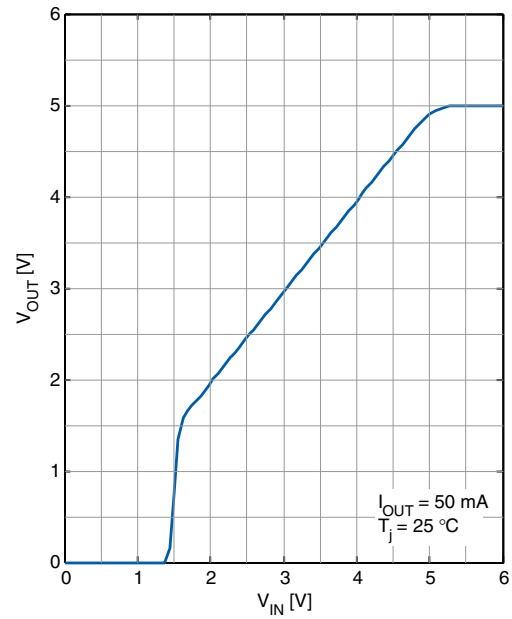

Dropout Voltage V_{dr} versus Junction Temperature T_j

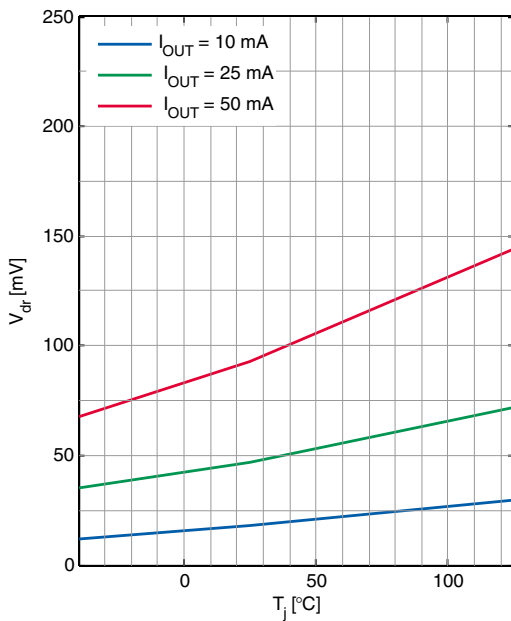

Dropout Voltage V_{dr} versus Output Current I_{OUT}

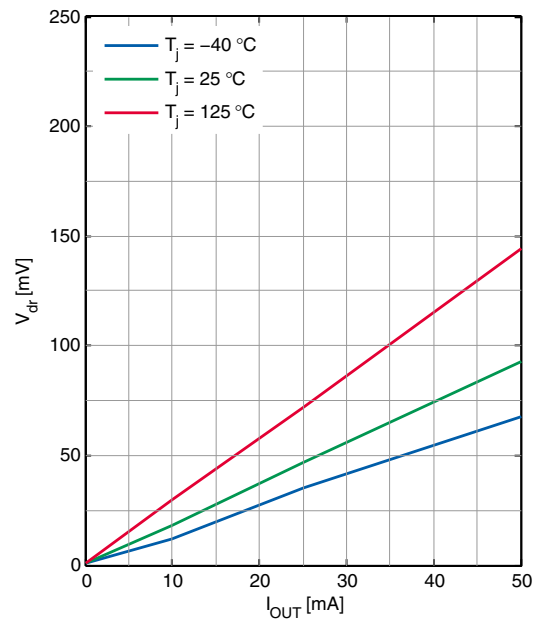

Load Regulation $\Delta V_{OUT,load}$ versus Output Current Change ΔI_{OUT}

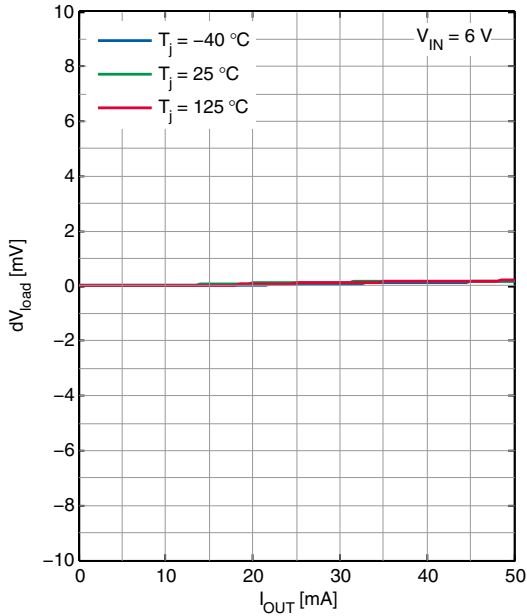

Line Regulation $\Delta V_{OUT,line}$ versus Input Voltage V_{IN}

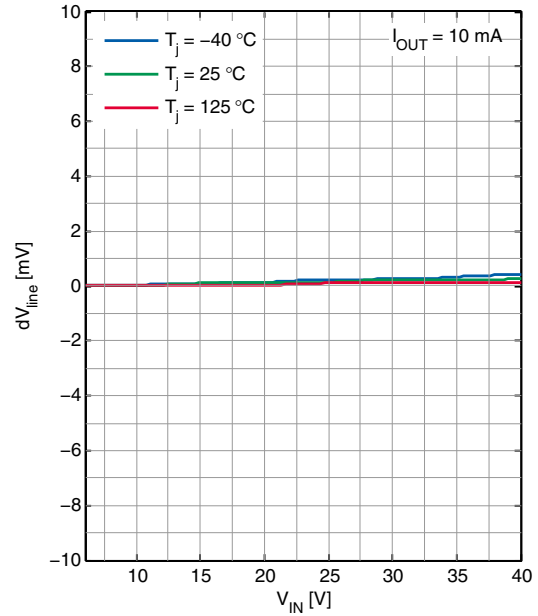

Power Supply Ripple Rejection $PSRR$ versus ripple frequency f_r

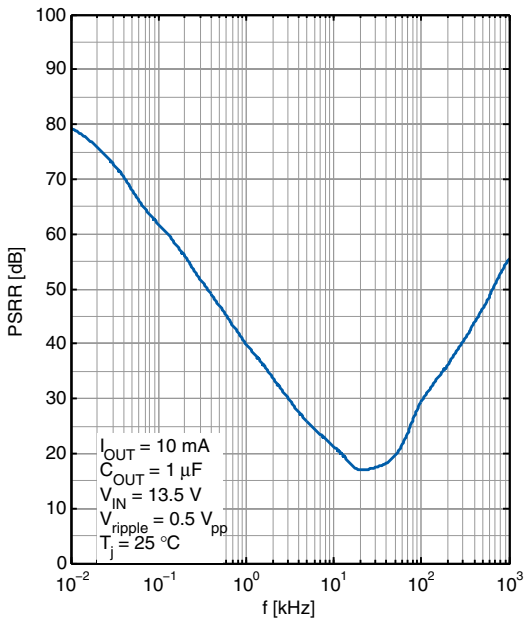

Output Capacitor Series Resistor $ESR(C_{OUT})$ versus Output Current I_{OUT}

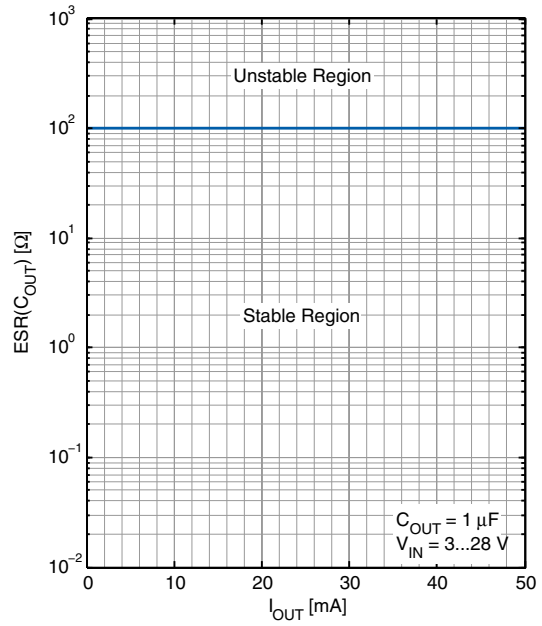

Maximum Output Current $I_{OUT,Max}$ versus Input Voltage V_{IN}

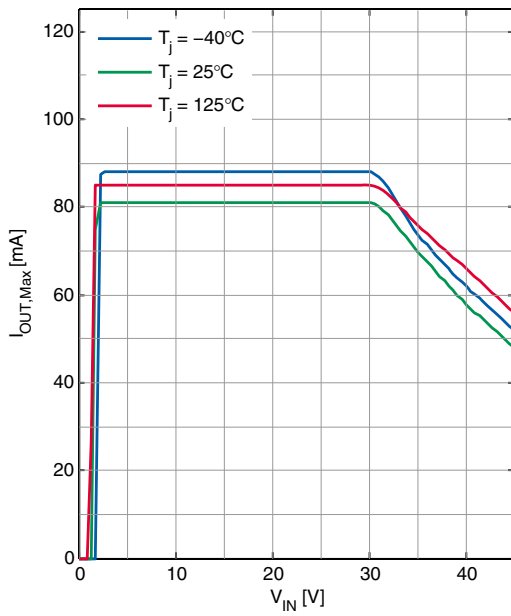

5.3 Current Consumption

Table 5 Electrical Characteristics Current Consumption IFX30081SJV

$T_j = -40^\circ\text{C}$ to $+125^\circ\text{C}$, $V_{\text{IN}} = 13.5\text{ V}$, all voltages with respect to ground; positive current defined flowing out of pin (unless otherwise specified).

Parameter	Symbol	Values			Unit	Note / Test Condition	Number
		Min.	Typ.	Max.			
Current Consumption $I_q = I_{\text{IN}}$	$I_{q,\text{OFF}}$	–	–	1	μA	$V_{\text{EN}} \leq 0.4\text{ V}$, $T_j < 105^\circ\text{C}$	P_5.3.1
Current Consumption $I_q = I_{\text{IN}} - I_{\text{OUT}}$	I_q	–	5	7.5	μA	$I_{\text{OUT}} = 50\mu\text{A}$, $T_j = 25^\circ\text{C}$	P_5.3.2
Current Consumption $I_q = I_{\text{IN}} - I_{\text{OUT}}$	I_q	–	6	10	μA	$I_{\text{OUT}} = 50\mu\text{A}$, $T_j < 105^\circ\text{C}$	P_5.3.3
Current Consumption $I_q = I_{\text{IN}} - I_{\text{OUT}}$	I_q	–	6.5	11	μA	$I_{\text{OUT}} = 50\mu\text{A}$, $T_j < 125^\circ\text{C}$	P_5.3.4
Current Consumption $I_q = I_{\text{IN}} - I_{\text{OUT}}$	I_q	–	6.5	11	μA	$I_{\text{OUT}} = 50\text{ mA}$, $T_j < 125^\circ\text{C}$	P_5.3.5

5.4 Typical Performance Characteristics Current Consumption

Typical Performance Characteristics

Current Consumption in OFF mode $I_{q,OFF}$ versus Junction Temperature T_j

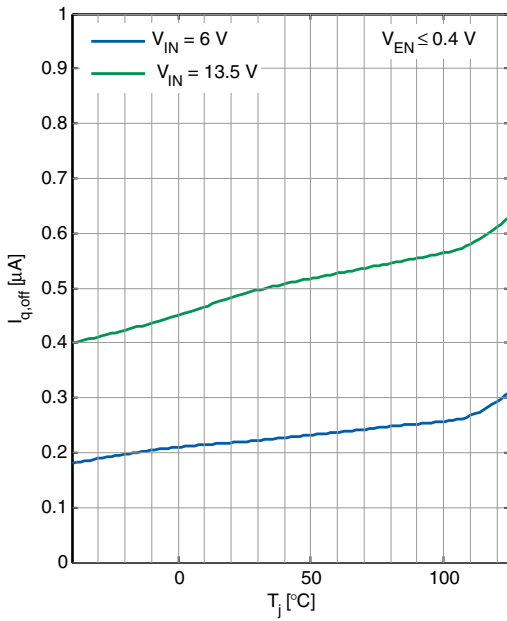

Current Consumption in OFF mode $I_{q,OFF}$ versus Input Voltage V_{IN}

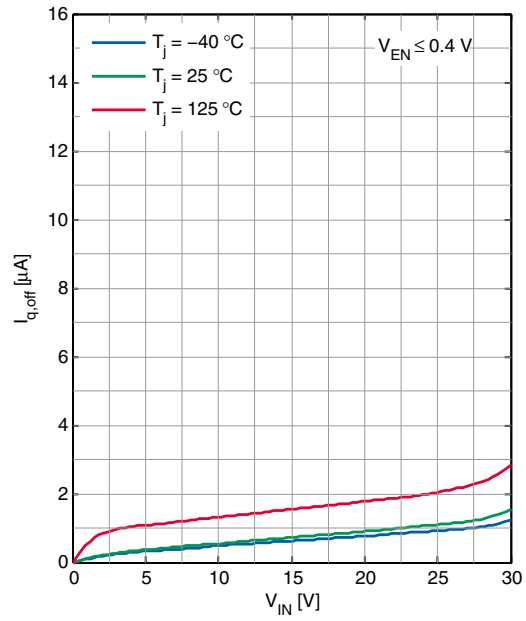

Current Consumption I_q versus Input Voltage V_{IN}

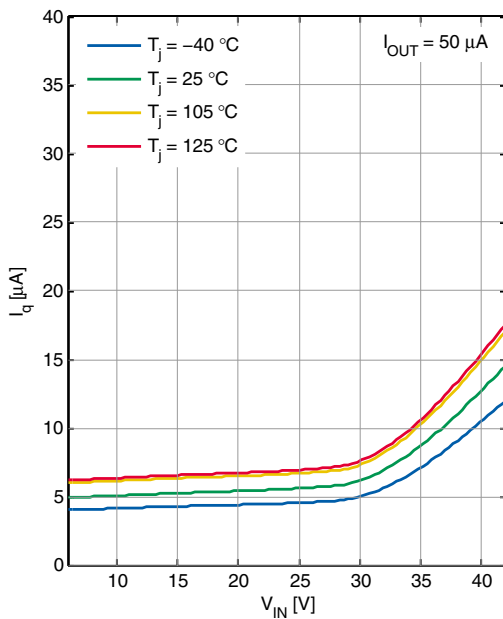

Current Consumption I_q versus Input Voltage V_{IN}

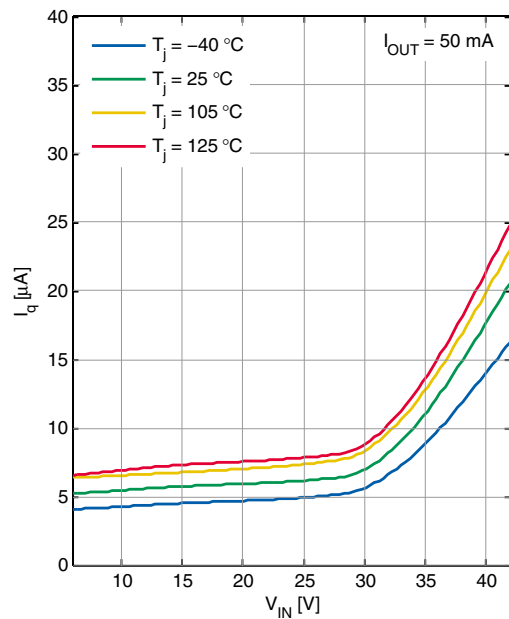

Current Consumption I_q versus Junction Temperature T_j

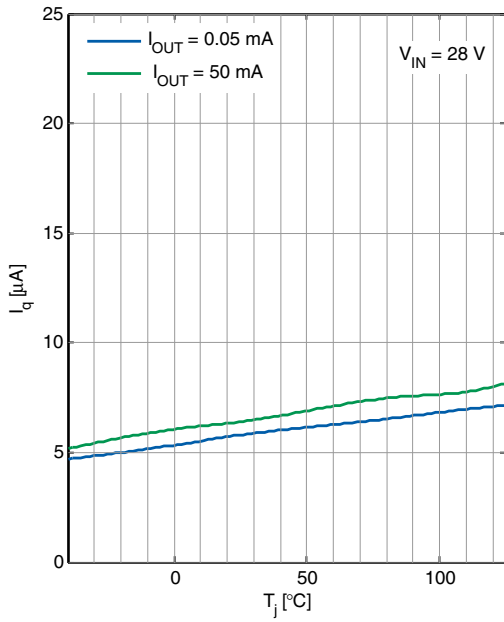

Current Consumption I_q versus Output Current I_{OUT}

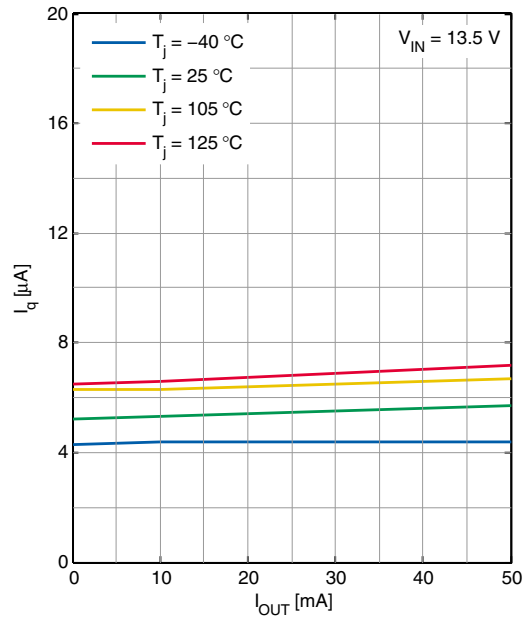

5.5 Enable

The device IFX30081SJV can be switched on and off by the Enable feature: Connect a HIGH level as specified below (e.g. the battery voltage) to pin EN to enable the device; connect a LOW level as specified below (e.g. GND) to shut it down. The enable has a build in hysteresis to avoid toggling between ON/OFF state, if signals with slow slopes are applied to the input.

Table 6 Electrical Characteristics Enable

$T_j = -40^{\circ}\text{C}$ to $+125^{\circ}\text{C}$, $V_{\text{IN}} = 13.5\text{ V}$, all voltages with respect to ground; positive current defined flowing out of pin (unless otherwise specified). Typical values are given at $T_j = 25^{\circ}\text{C}$, $V_{\text{IN}} = 13.5\text{ V}$

Parameter	Symbol	Values			Unit	Note / Test Condition	Number
		Min.	Typ.	Max.			
High Level Input Voltage	$V_{\text{EN,H}}$	2	–	–	V	V_{OUT} settled	P_5.5.1
Low Level Input Voltage	$V_{\text{EN,L}}$	–	–	0.8	V	$V_{\text{OUT}} \leq 0.1\text{ V}$	P_5.5.2
High Level Input Current	$I_{\text{EN,H}}$	–	–	4	μA	$V_{\text{EN}} = 5\text{ V}$	P_5.5.4
Enable Internal Pull-down Resistor	R_{EN}	1.25	2	3.5	$\text{M}\Omega$		P_5.5.6

5.6 Typical Performance Characteristics Enable

Typical Performance Characteristics

Enable Input Voltage V_{EN} versus Junction Temperature T_j

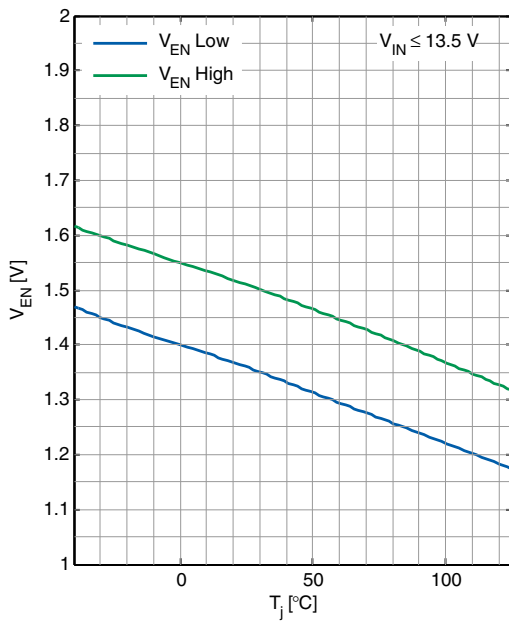

Enable Input Current I_{EN} versus Enable Input Voltage V_{EN}

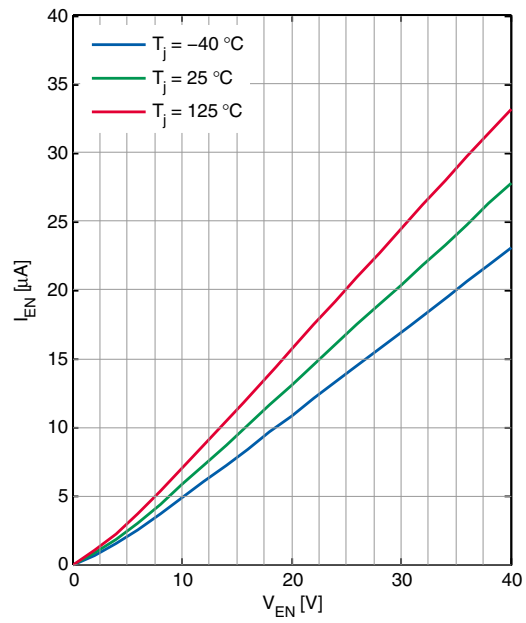

6 Application Information

Note: The following information is given as a hint for the implementation of the device only and shall not be regarded as a description or warranty of a certain functionality, condition or quality of the device.

6.1 Application Diagram

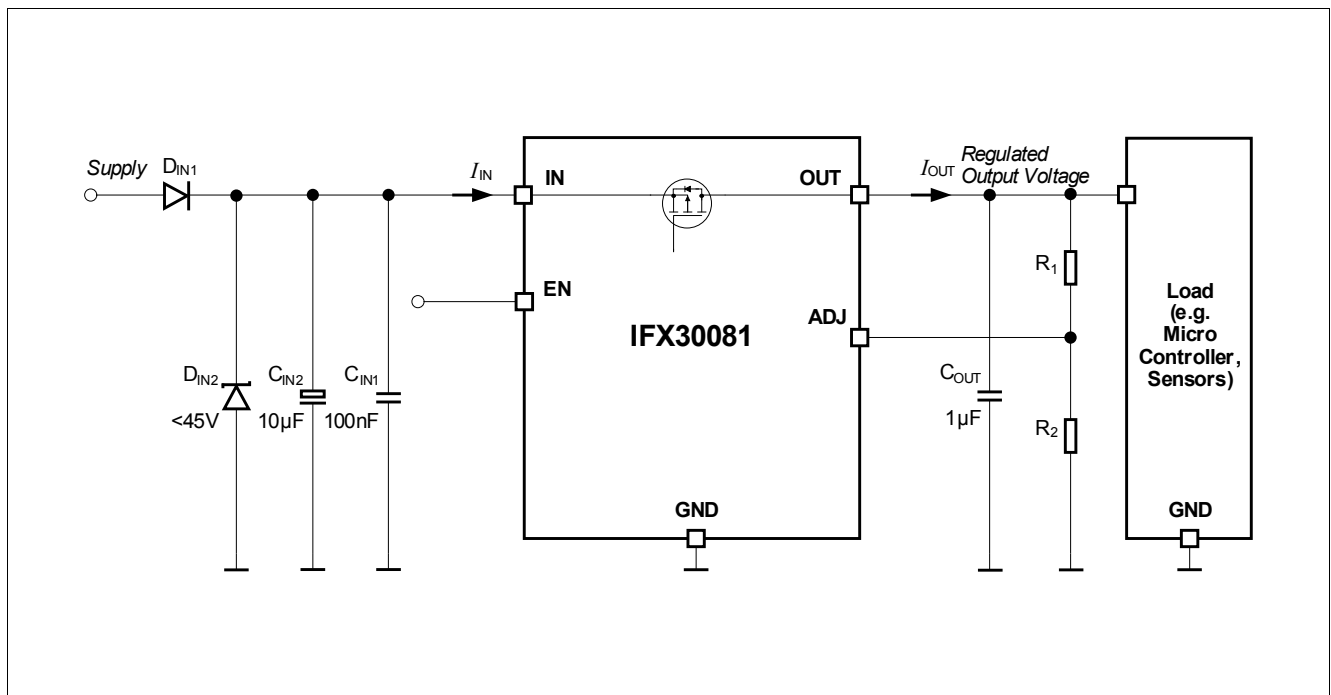

Figure 4 Application Diagram IFX30081SJV

6.2 Selection of External Components

6.2.1 Input Pin

The typical input circuitry for a linear voltage regulator is shown in the application diagram above.

A ceramic capacitor at the input, in the range of 100 nF to 470 nF, is recommended to filter out the high frequency disturbances imposed by the line. This capacitor must be placed very close to the input pin of the linear voltage regulator on the PCB.

An aluminum electrolytic capacitor in the range of 10 μF to 470 μF is recommended as an input buffer to smooth out high energy pulses. This capacitor should be placed close to the input pin of the linear voltage regulator on the PCB.

An overvoltage suppressor diode can be used to further suppress any high voltage beyond the maximum rating of the linear voltage regulator and protect the device against any damage due to over-voltage.

The external components at the input are not mandatory for the operation of the voltage regulator, but they are recommended in case of possible external disturbances.

6.2.2 Output Pin

An output capacitor is mandatory for the stability of linear voltage regulators.

The requirement to the output capacitor is given in **“Functional Range” on Page 7**. The graph **“Output Capacitor Series Resistor ESR(C_{OUT}) versus Output Current I_{OUT} ” on Page 12** shows the stable operation range of the device.

IFX30081SJV is designed to be stable with extremely low ESR capacitors.

The output capacitor should be placed as close as possible to the regulator’s output and GND pins and on the same side of the PCB as the regulator itself.

In case of rapid transients of input voltage or load current, the capacitance should be dimensioned in accordance and verified in the real application that the output stability requirements are fulfilled.

6.3 Output Voltage Adjust

The output voltage of IFX30081SJV can be adjusted between 1.2 V and $V_{IN} - V_{dr}$ by an external resistor divider, connected to the adjust pin ADJ, as shown in **Figure 4**.

The ADJ pin is connected internally to an error amplifier comparing the voltage at this pin with the internal reference voltage of typically 1.2 V.

The output voltage can be easily calculated, neglecting the current flowing into the ADJ pin:

$$V_{OUT} = \frac{R_1 + R_2}{R_2} \times V_{ref} \quad (6.1)$$

with

- V_{ref} : internal reference voltage, typically 1.2V
- R_1 : resistor between regulator output OUT and adjust pin ADJ
- R_2 : resistor between adjust pin ADJ and GND

The bigger the resistors R_1 and R_2 , the less the current flowing through the resistor divider. However, using very big resistors makes the current flowing into the ADJ pin non-negligible. In order to neglect the current flowing into the ADJ pin, the values of R_1 and R_2 should be selected fulfilling the criteria $R_2 \leq 250 \text{ k}\Omega$.

To set the output voltage to 1.2 V, the adjust pin ADJ should be directly connected to the output pin OUT.

Take into consideration that an additional error to the output voltage tolerance may be introduced by the accuracy of the resistors R_1 and R_2 .

6.4 Thermal Considerations

Knowing the input voltage, the output voltage and the load profile of the application, the total power dissipation can be calculated:

$$P_D = (V_{IN} - V_{OUT}) \times I_{OUT} + V_{IN} \times I_q \quad (6.2)$$

with

- P_D : continuous power dissipation
- V_{IN} : input voltage
- V_{OUT} : output voltage
- I_{OUT} : output current
- I_q : quiescent current

The maximum acceptable thermal resistance R_{thJA} can then be calculated:

$$R_{thJA, \max} = \frac{T_{j, \max} - T_a}{P_D} \quad (6.3)$$

with

- $T_{j, \max}$: maximum allowed junction temperature
- T_a : ambient temperature

Based on the above calculation the proper PCB type and the necessary heat sink area can be determined with reference to the specification in **“Thermal Resistance” on Page 8**.

Example

Application conditions:

$$V_{IN} = 12 \text{ V}$$

$$V_{OUT} = 5 \text{ V}$$

$$I_{OUT} = 40 \text{ mA}$$

$$T_a = 85 \text{ °C}$$

Calculation of $R_{thJA, \max}$:

$$\begin{aligned} P_D &= (V_{IN} - V_{OUT}) \times I_{OUT} + V_{IN} \times I_q \\ &= (12\text{V} - 5\text{V}) \times 40 \text{ mA} + 12 \text{ V} \times 0.0115 \text{ mA} \\ &= 0.28 \text{ W} \end{aligned}$$

$$\begin{aligned} R_{thJA, \max} &= (T_{j, \max} - T_a) / P_D \\ &= (125 \text{ °C} - 85 \text{ °C}) / 0.28 \text{ W} \\ &= 142.857 \text{ K/W} \end{aligned}$$

As a result, the PCB design must ensure a thermal resistance R_{thJA} lower than 143 K/W. According to **“Thermal Resistance” on Page 8**, at least 300 mm² heatsink area is needed on a FR4 1s0p PCB, or the FR4 2s2p board could be used for this application.

6.5 Reverse Polarity Protection

IFX30081SJV is not self protected against reverse polarity faults. To protect the device against negative supply voltage, an external reverse polarity diode is needed, as shown in **Figure 4**. The absolute maximum ratings of the device as specified in **“Absolute Maximum Ratings” on Page 6** must be kept.

6.6 Further Application Information

For further information you may contact <http://www.infineon.com/>

7 Package Outlines

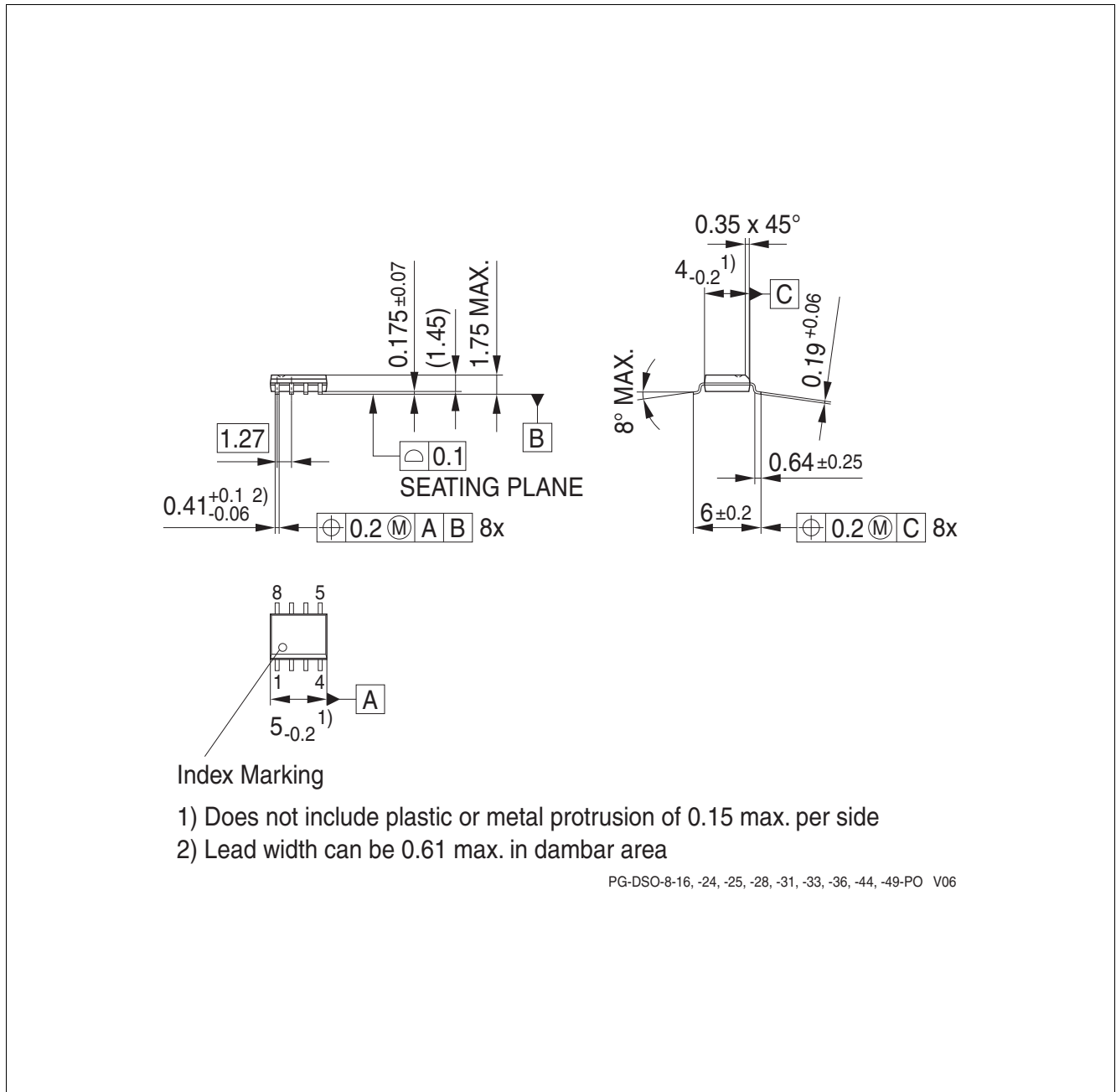

Index Marking

- 1) Does not include plastic or metal protrusion of 0.15 max. per side
- 2) Lead width can be 0.61 max. in dambar area

PG-DSO-8-16, -24, -25, -28, -31, -33, -36, -44, -49-PO V06

Figure 5 Package Outline PG-DSO-8 (Plastic Dual Small Outline Package) (RoHS-Compliant)

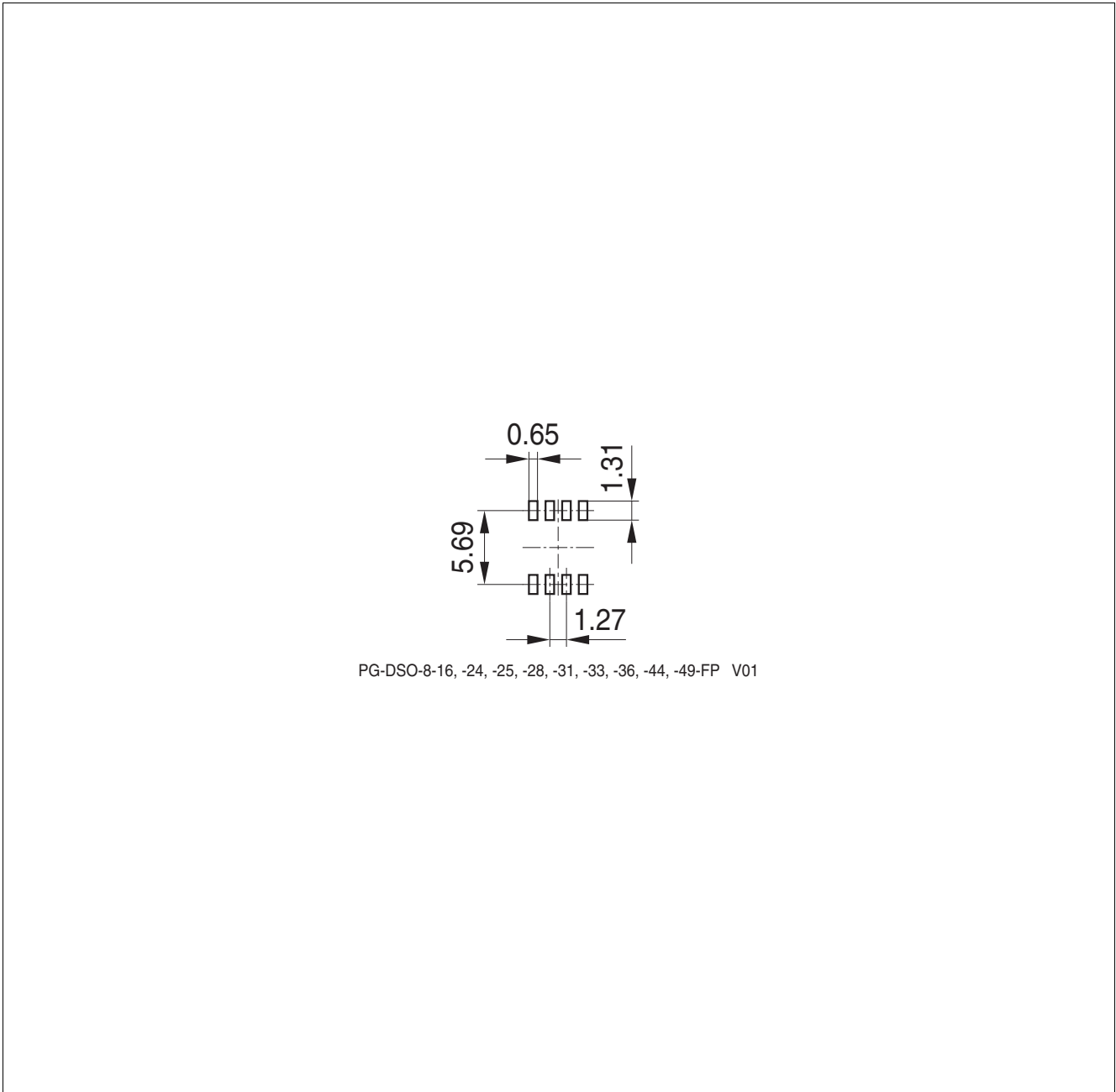

Figure 6 Footprint PG-DSO-8 (Plastic Dual Small Outline Package) (RoHS-Compliant)

Green Product (RoHS compliant)

To meet the world-wide customer requirements for environmentally friendly products and to be compliant with government regulations the device is available as a green product. Green products are RoHS-Compliant (i.e. Pb-free finish on leads and suitable for Pb-free soldering according to IPC/JEDEC J-STD-020).

8 Revision History

Revision	Date	Changes
1.0	2015-02-04	Data Sheet - Initial Version

Edition 2015-02-04

**Published by
Infineon Technologies AG
81726 Munich, Germany**

**© 2013 Infineon Technologies AG
All Rights Reserved.**

Legal Disclaimer

The information given in this document shall in no event be regarded as a guarantee of conditions or characteristics. With respect to any examples or hints given herein, any typical values stated herein and/or any information regarding the application of the device, Infineon Technologies hereby disclaims any and all warranties and liabilities of any kind, including without limitation, warranties of non-infringement of intellectual property rights of any third party.

Information

For further information on technology, delivery terms and conditions and prices, please contact the nearest Infineon Technologies Office (www.infineon.com).

Warnings

Due to technical requirements, components may contain dangerous substances. For information on the types in question, please contact the nearest Infineon Technologies Office.

The Infineon Technologies component described in this Data Sheet may be used in life-support devices or systems and/or automotive, aviation and aerospace applications or systems only with the express written approval of Infineon Technologies, if a failure of such components can reasonably be expected to cause the failure of that life-support automotive, aviation and aerospace device or system or to affect the safety or effectiveness of that device or system. Life support devices or systems are intended to be implanted in the human body or to support and/or maintain and sustain and/or protect human life. If they fail, it is reasonable to assume that the health of the user or other persons may be endangered.