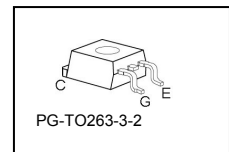
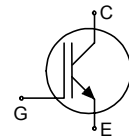


## HighSpeed 2-Technology

- Designed for frequency inverters for washing machines, fans, pumps and vacuum cleaners
- 2<sup>nd</sup> generation HighSpeed-Technology for 1200V applications offers:**
  - loss reduction in resonant circuits
  - temperature stable behavior
  - parallel switching capability
  - tight parameter distribution
  - $E_{off}$  optimized for  $I_C=1A$
- Qualified according to JEDEC<sup>2</sup> for target applications
- Pb-free lead plating; RoHS compliant
- Complete product spectrum and PSpice Models : <http://www.infineon.com/igbt/>



Type	$V_{CE}$	$I_C$	$E_{off}$	$T_j$	Marking	Package
IGB01N120H2	1200V	1A	0.09mJ	150°C	G01H1202	PG-TO-263-3-2

### Maximum Ratings

Parameter	Symbol	Value	Unit
Collector-emitter voltage	$V_{CE}$	1200	V
Triangular collector current	$I_C$		A
$T_C = 25^\circ\text{C}, f = 140\text{kHz}$		3.2	
$T_C = 100^\circ\text{C}, f = 140\text{kHz}$		1.3	
Pulsed collector current, $t_p$ limited by $T_{jmax}$	$I_{Cpuls}$	3.5	
Turn off safe operating area	-	3.5	
$V_{CE} \leq 1200\text{V}, T_j \leq 150^\circ\text{C}$			
Gate-emitter voltage	$V_{GE}$	$\pm 20$	V
Power dissipation	$P_{tot}$	28	W
$T_C = 25^\circ\text{C}$			
Operating junction and storage temperature	$T_j, T_{stg}$	-40...+150	°C
Soldering temperature (reflow soldering, MSL1)	-	245	

<sup>2</sup> J-STD-020 and JESD-022

**Thermal Resistance**

Parameter	Symbol	Conditions	Max. Value	Unit
<b>Characteristic</b>				
IGBT thermal resistance, junction – case	$R_{thJC}$		4.5	K/W
Thermal resistance, junction – ambient <sup>1)</sup>	$R_{thJA}$	PG-TO-220-3-1	40	

**Electrical Characteristic, at  $T_j = 25\text{ }^\circ\text{C}$ , unless otherwise specified**

Parameter	Symbol	Conditions	Value			Unit
			min.	Typ.	max.	
<b>Static Characteristic</b>						
Collector-emitter breakdown voltage	$V_{(BR)CES}$	$V_{GE}=0V, I_C=300\mu A$	1200	-	-	V
Collector-emitter saturation voltage	$V_{CE(sat)}$	$V_{GE} = 15V, I_C=1A$ $T_j=25^\circ C$ $T_j=150^\circ C$	-	2.2	2.8	
			$V_{GE} = 10V, I_C=1A,$ $T_j=25^\circ C$	-	2.4	
Gate-emitter threshold voltage	$V_{GE(th)}$	$I_C=30\mu A, V_{CE}=V_{GE}$	2.1	3	3.9	
Zero gate voltage collector current	$I_{CES}$	$V_{CE}=1200V, V_{GE}=0V$ $T_j=25^\circ C$ $T_j=150^\circ C$	-	-	20	$\mu A$
			-	-	80	
Gate-emitter leakage current	$I_{GES}$	$V_{CE}=0V, V_{GE}=20V$	-	-	40	nA
Transconductance	$g_{fs}$	$V_{CE}=20V, I_C=1A$	-	0.75	-	S
<b>Dynamic Characteristic</b>						
Input capacitance	$C_{iss}$	$V_{CE}=25V,$ $V_{GE}=0V,$ $f=1MHz$	-	91.6	-	pF
Output capacitance	$C_{oss}$		-	9.8	-	
Reverse transfer capacitance	$C_{riss}$		-	3.4	-	
Gate charge	$Q_{Gate}$	$V_{CC}=960V, I_C=1A$ $V_{GE}=15V$	-	8.6	-	nC
Internal emitter inductance measured 5mm (0.197 in.) from case	$L_E$		-	7	-	nH

<sup>1)</sup> Device on 50mm\*50mm\*1.5mm epoxy PCB FR4 with 6cm<sup>2</sup> (one layer, 70μm thick) copper area for collector connection. PCB is vertical without blown air.

**Switching Characteristic, Inductive Load, at  $T_j=25^\circ\text{C}$** 

Parameter	Symbol	Conditions	Value			Unit
			min.	Typ.	max.	
<b>IGBT Characteristic</b>						
Turn-on delay time	$t_{d(on)}$	$T_j=25^\circ\text{C}$ , $V_{CC}=800\text{V}$ , $I_C=1\text{A}$ , $V_{GE}=15\text{V}/0\text{V}$ , $R_G=241\Omega$ , $L_\sigma^{2)}=180\text{nH}$ , $C_\sigma^{2)}=40\text{pF}$ Energy losses include "tail" and diode <sup>3)</sup> reverse recovery.	-	13	-	ns
Rise time	$t_r$		-	6.3	-	
Turn-off delay time	$t_{d(off)}$		-	370	-	
Fall time	$t_f$		-	28	-	
Turn-on energy	$E_{on}$		-	0.08	-	mJ
Turn-off energy	$E_{off}$		-	0.06	-	
Total switching energy	$E_{ts}$		-	0.14	-	

**Switching Characteristic, Inductive Load, at  $T_j=150^\circ\text{C}$** 

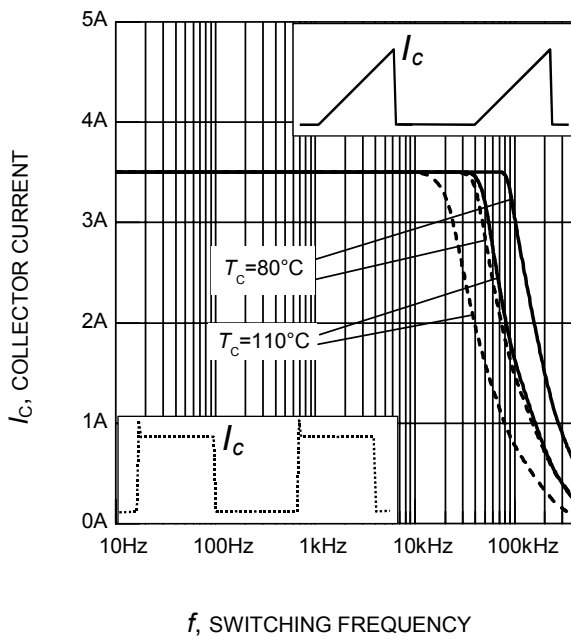
Parameter	Symbol	Conditions	Value			Unit
			min.	Typ.	max.	
<b>IGBT Characteristic</b>						
Turn-on delay time	$t_{d(on)}$	$T_j=150^\circ\text{C}$ $V_{CC}=800\text{V}$ , $I_C=1\text{A}$ , $V_{GE}=15\text{V}/0\text{V}$ , $R_G=241\Omega$ , $L_\sigma^{2)}=180\text{nH}$ , $C_\sigma^{2)}=40\text{pF}$ Energy losses include "tail" and diode <sup>4)</sup> reverse recovery.	-	12	-	ns
Rise time	$t_r$		-	8.9	-	
Turn-off delay time	$t_{d(off)}$		-	450	-	
Fall time	$t_f$		-	43	-	
Turn-on energy	$E_{on}$		-	0.11	-	mJ
Turn-off energy	$E_{off}$		-	0.09	-	
Total switching energy	$E_{ts}$		-	0.2	-	

**Switching Energy ZVT, Inductive Load**

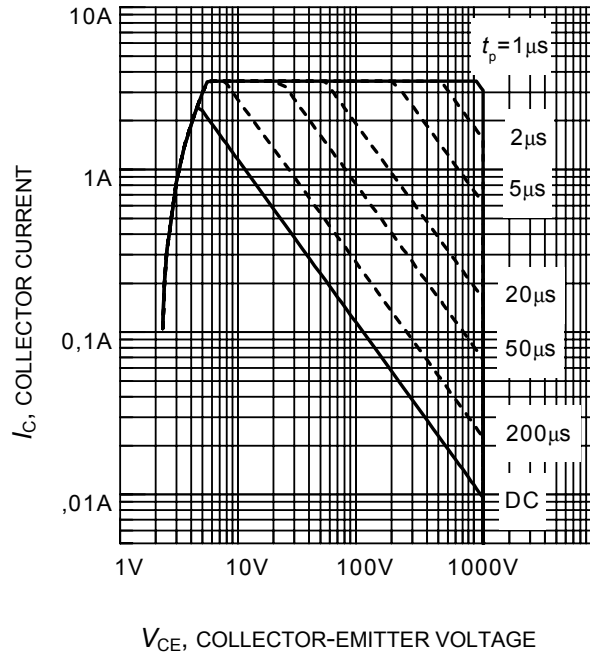
Parameter	Symbol	Conditions	Value			Unit
			min.	Typ.	max.	
<b>IGBT Characteristic</b>						
Turn-off energy	$E_{off}$	$V_{CC}=800\text{V}$ , $I_C=1\text{A}$ , $V_{GE}=15\text{V}/0\text{V}$ , $R_G=241\Omega$ , $C_r^{2)}=1\text{nF}$ $T_j=25^\circ\text{C}$ $T_j=150^\circ\text{C}$	-	0.02 0.044	-	mJ
			-		-	

<sup>2)</sup> Leakage inductance  $L_\sigma$  and stray capacity  $C_\sigma$  due to dynamic test circuit in figure E

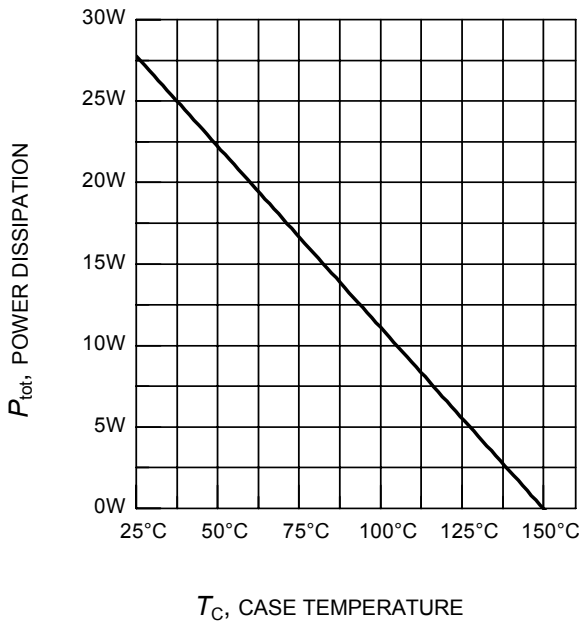
<sup>4)</sup> Commutation diode from device IKP01N120H2



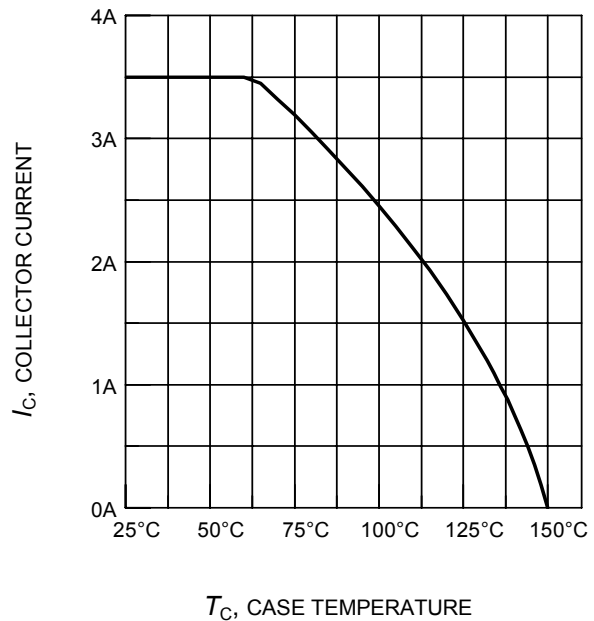
**Figure 1. Collector current as a function of switching frequency**  
 ( $T_j \leq 150^\circ\text{C}$ ,  $D = 0.5$ ,  $V_{CE} = 800\text{V}$ ,  $V_{GE} = +15\text{V}/0\text{V}$ ,  $R_G = 241\Omega$ )



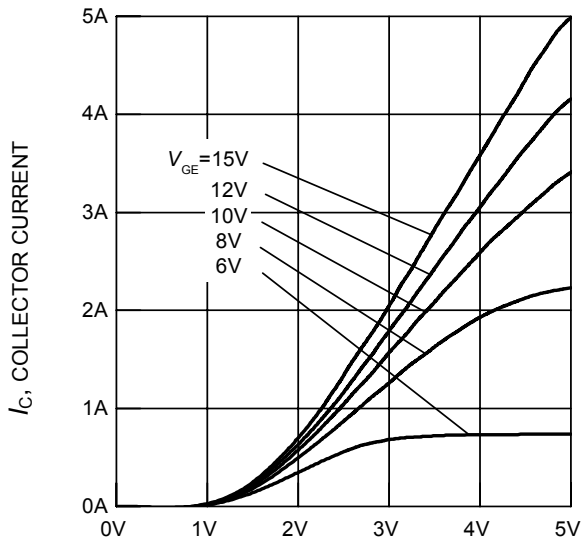
**Figure 2. Safe operating area**  
 ( $D = 0$ ,  $T_C = 25^\circ\text{C}$ ,  $T_j \leq 150^\circ\text{C}$ )



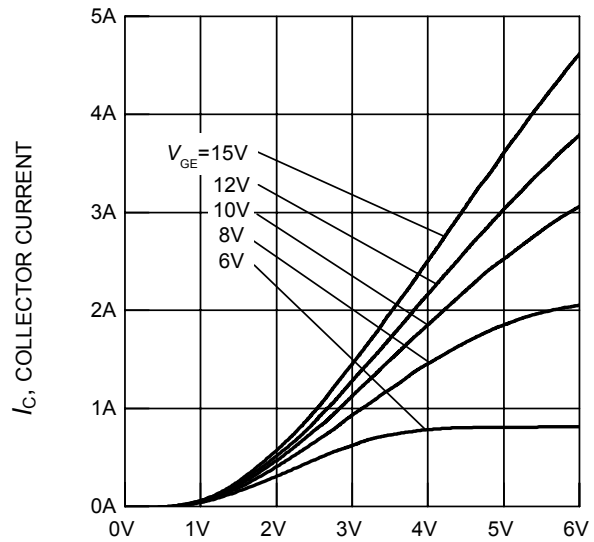
**Figure 3. Power dissipation as a function of case temperature**  
 ( $T_j \leq 150^\circ\text{C}$ )



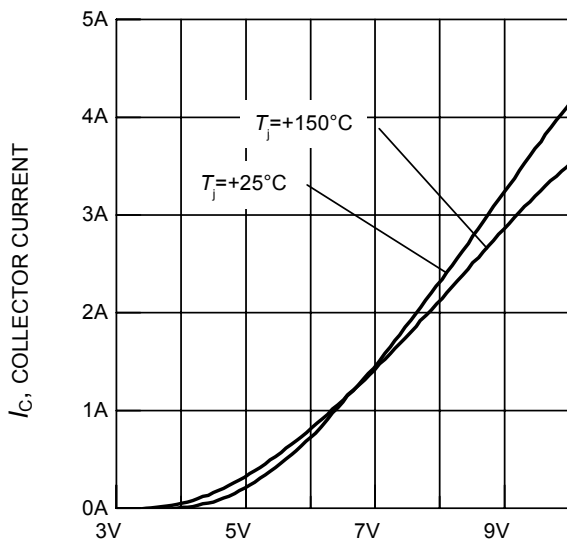
**Figure 4. Collector current as a function of case temperature**  
 ( $V_{GE} \leq 15\text{V}$ ,  $T_j \leq 150^\circ\text{C}$ )



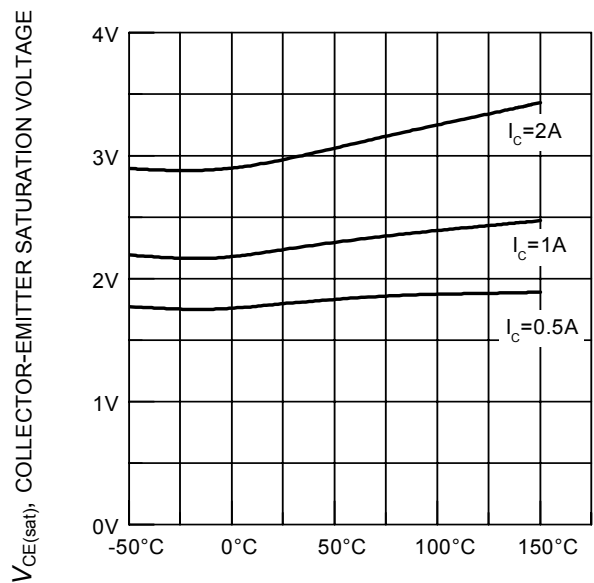
$V_{CE}$ , COLLECTOR-EMITTER VOLTAGE  
**Figure 5. Typical output characteristics**  
 ( $T_j = 25^\circ\text{C}$ )



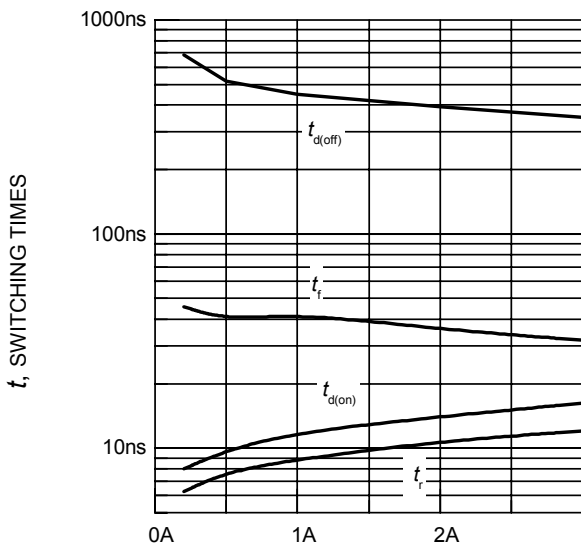
$V_{CE}$ , COLLECTOR-EMITTER VOLTAGE  
**Figure 6. Typical output characteristics**  
 ( $T_j = 150^\circ\text{C}$ )



$V_{GE}$ , GATE-EMITTER VOLTAGE  
**Figure 7. Typical transfer characteristics**  
 ( $V_{CE} = 20\text{V}$ )



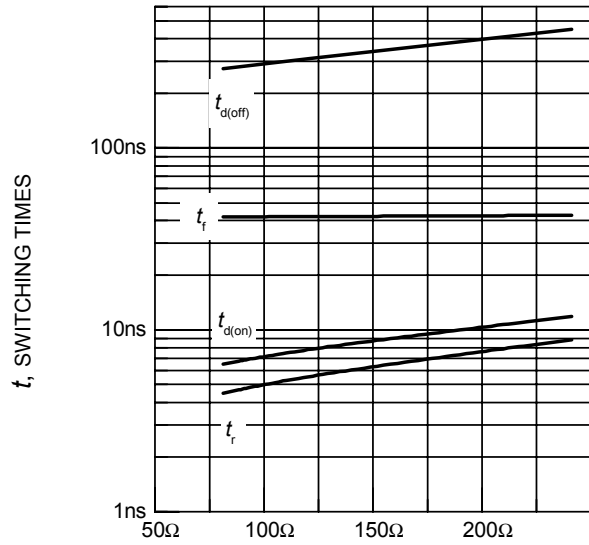
$T_j$ , JUNCTION TEMPERATURE  
**Figure 8. Typical collector-emitter saturation voltage as a function of junction temperature**  
 ( $V_{GE} = 15\text{V}$ )



$I_C$ , COLLECTOR CURRENT

**Figure 9. Typical switching times as a function of collector current**

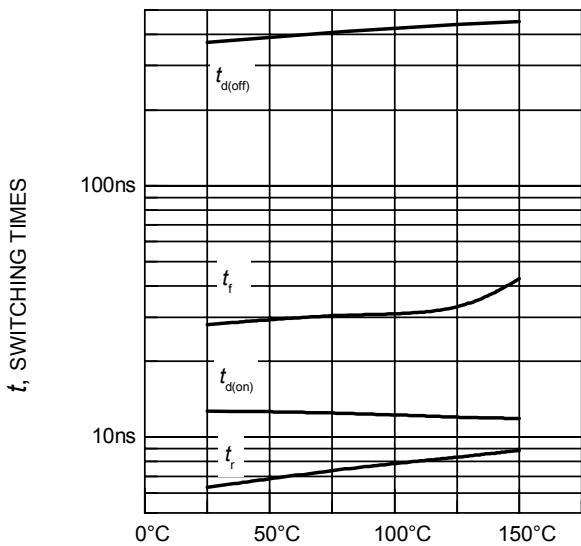
(inductive load,  $T_j = 150^\circ\text{C}$ ,  $V_{CE} = 800\text{V}$ ,  $V_{GE} = +15\text{V}/0\text{V}$ ,  $R_G = 241\Omega$ , dynamic test circuit in Fig.E)



$R_G$ , GATE RESISTOR

**Figure 10. Typical switching times as a function of gate resistor**

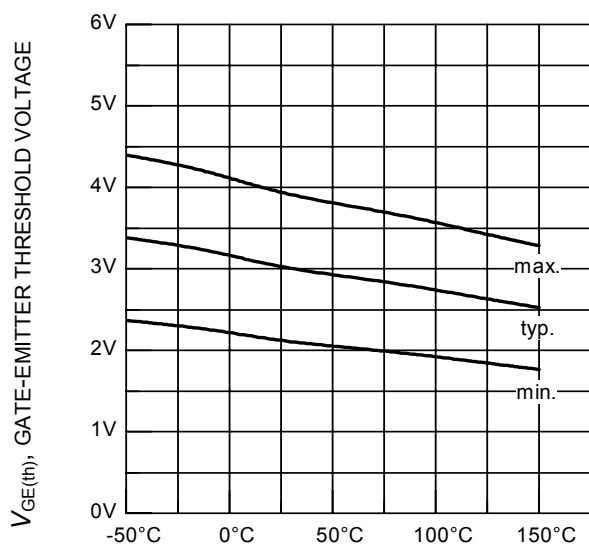
(inductive load,  $T_j = 150^\circ\text{C}$ ,  $V_{CE} = 800\text{V}$ ,  $V_{GE} = +15\text{V}/0\text{V}$ ,  $I_C = 1\text{A}$ , dynamic test circuit in Fig.E)



$T_j$ , JUNCTION TEMPERATURE

**Figure 11. Typical switching times as a function of junction temperature**

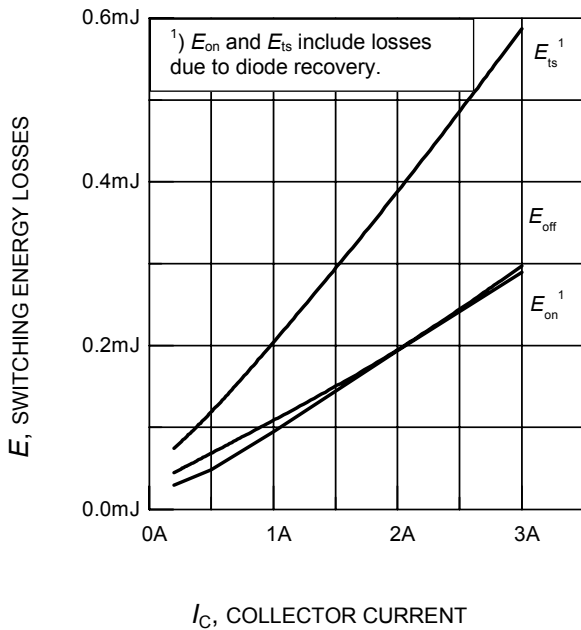
(inductive load,  $V_{CE} = 800\text{V}$ ,  $V_{GE} = +15\text{V}/0\text{V}$ ,  $I_C = 1\text{A}$ ,  $R_G = 241\Omega$ , dynamic test circuit in Fig.E)



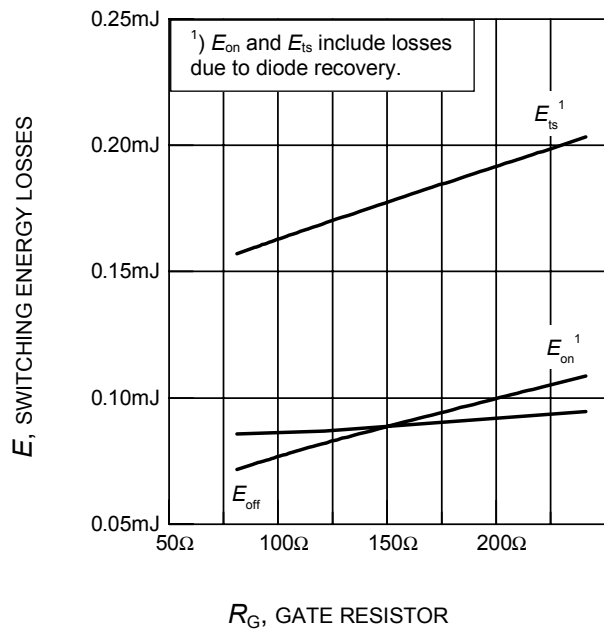
$T_j$ , JUNCTION TEMPERATURE

**Figure 12. Gate-emitter threshold voltage as a function of junction temperature**

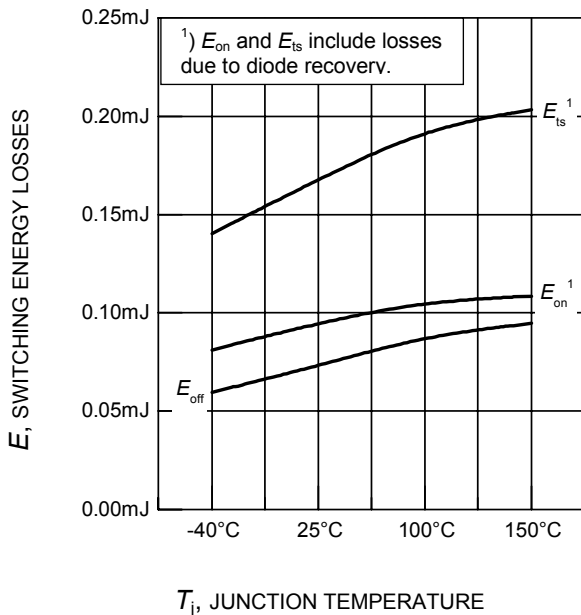
( $I_C = 0.03\text{mA}$ )



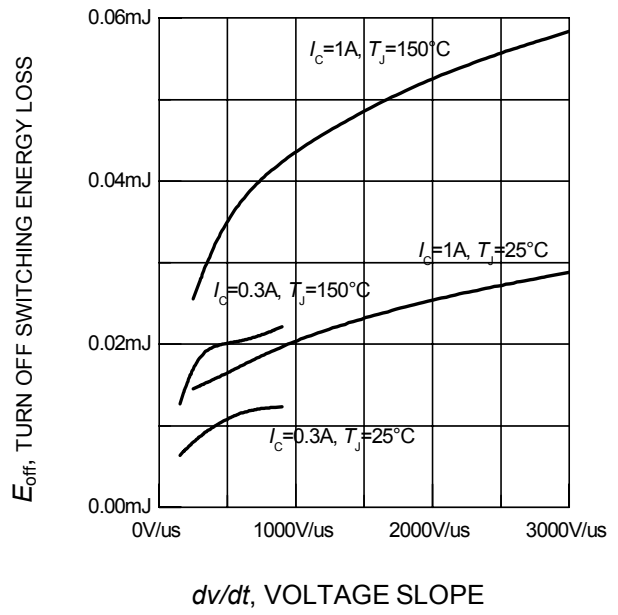
$I_C$ , COLLECTOR CURRENT  
**Figure 13. Typical switching energy losses as a function of collector current**  
 (inductive load,  $T_j = 150^\circ\text{C}$ ,  $V_{CE} = 800\text{V}$ ,  $V_{GE} = +15\text{V}/0\text{V}$ ,  $R_G = 241\Omega$ , dynamic test circuit in Fig.E )



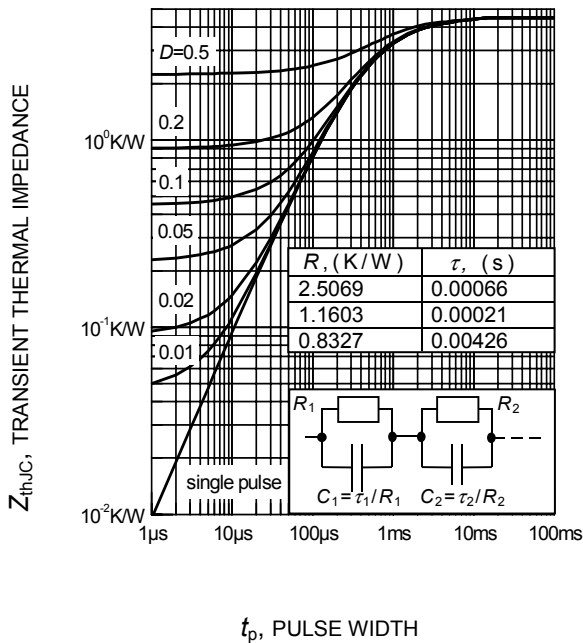
$R_G$ , GATE RESISTOR  
**Figure 14. Typical switching energy losses as a function of gate resistor**  
 (inductive load,  $T_j = 150^\circ\text{C}$ ,  $V_{CE} = 800\text{V}$ ,  $V_{GE} = +15\text{V}/0\text{V}$ ,  $I_C = 1\text{A}$ , dynamic test circuit in Fig.E )



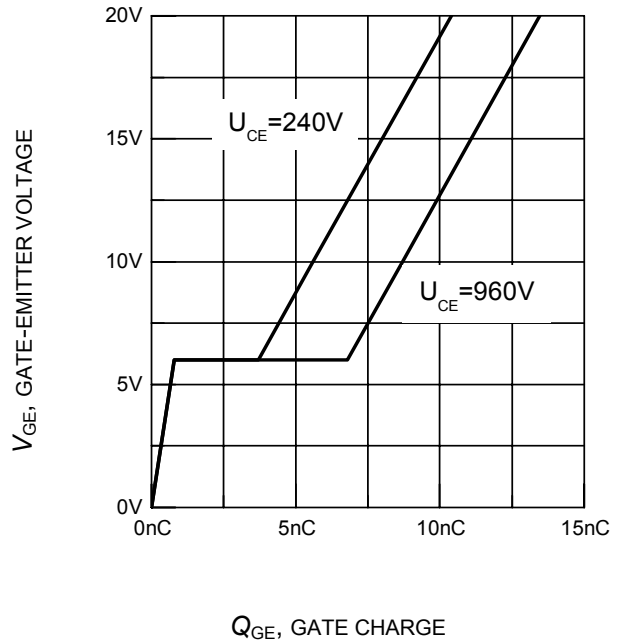
$T_j$ , JUNCTION TEMPERATURE  
**Figure 15. Typical switching energy losses as a function of junction temperature**  
 (inductive load,  $V_{CE} = 800\text{V}$ ,  $V_{GE} = +15\text{V}/0\text{V}$ ,  $I_C = 1\text{A}$ ,  $R_G = 241\Omega$ , dynamic test circuit in Fig.E )



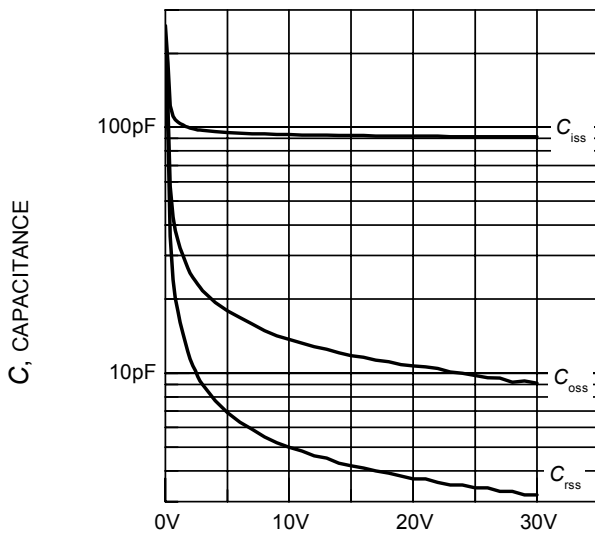
$dv/dt$ , VOLTAGE SLOPE  
**Figure 16. Typical turn off switching energy loss for soft switching**  
 (dynamic test circuit in Fig. E)



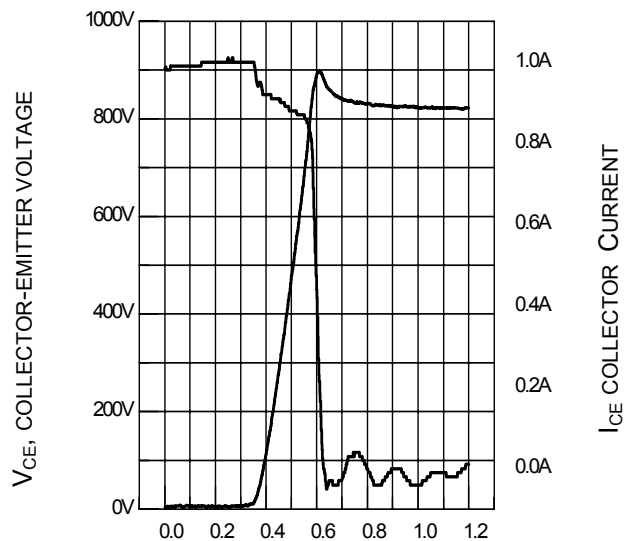
**Figure 17. IGBT transient thermal impedance as a function of pulse width**  
 $(D = t_p / T)$



**Figure 18. Typical gate charge**  
 $(I_C = 1A)$

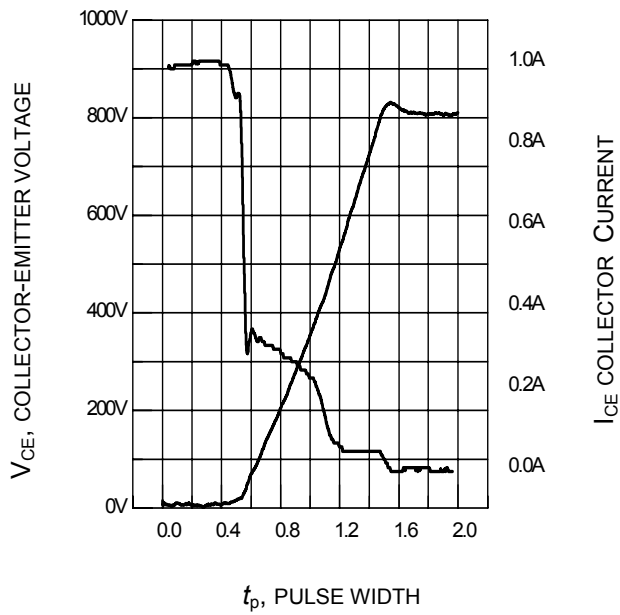


**Figure 19. Typical capacitance as a function of collector-emitter voltage**  
 $(V_{GE} = 0V, f = 1MHz)$



**Figure 20. Typical turn off behavior, hard switching**  
 $(V_{GE}=15/0V, R_G=220\Omega, T_j = 150^\circ C,$   
 Dynamic test circuit in Figure E)

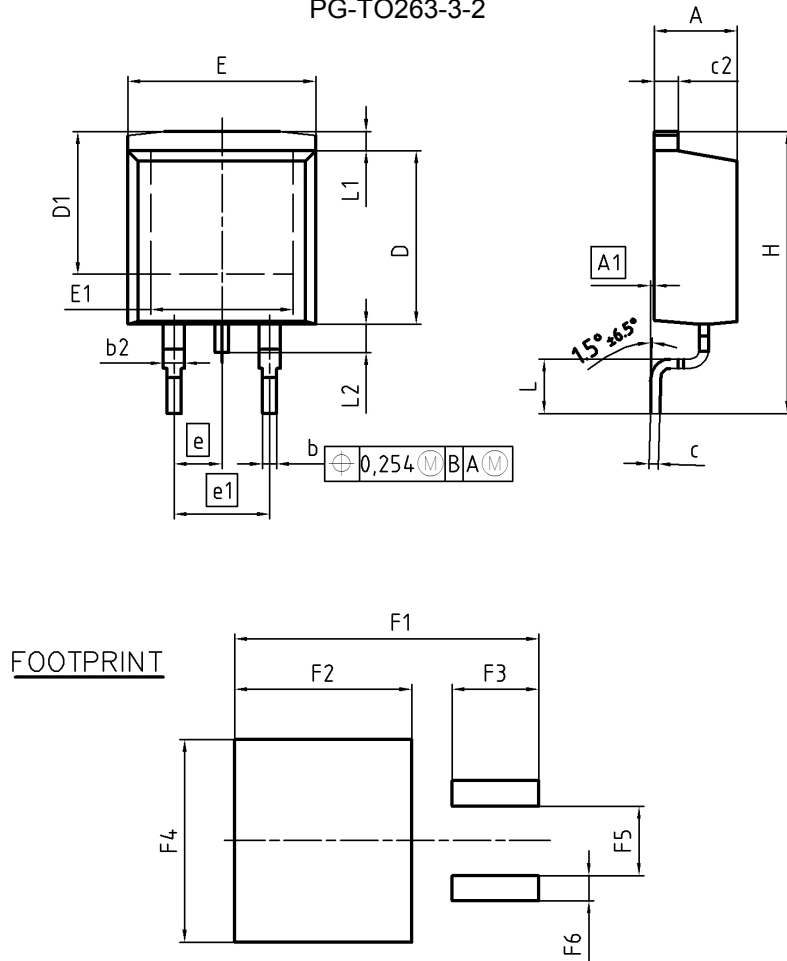




**Figure 21. Typical turn off behavior, soft switching**

( $V_{GE}=15/0V$ ,  $R_G=220\Omega$ ,  $T_j = 150^\circ C$ ,  
Dynamic test circuit in Figure E)

PG-TO263-3-2



DIM	MILLIMETERS		INCHES	
	MIN	MAX	MIN	MAX
A	4.30	4.57	0.169	0.180
A1	0.00	0.25	0.000	0.010
b	0.65	0.85	0.026	0.033
b2	0.95	1.15	0.037	0.045
c	0.33	0.65	0.013	0.026
c2	1.17	1.40	0.046	0.055
D	8.51	9.45	0.335	0.372
D1	7.10	7.90	0.280	0.311
E	9.80	10.31	0.386	0.406
E1	6.50	8.60	0.256	0.339
e	2.54		0.100	
e1	5.08		0.200	
N	2		2	
H	14.61	15.88	0.575	0.625
L	2.29	3.00	0.090	0.118
L1	0.70	1.60	0.028	0.063
L2	1.00	1.78	0.039	0.070
F1	16.05	16.25	0.632	0.640
F2	9.30	9.50	0.366	0.374
F3	4.50	4.70	0.177	0.185
F4	10.70	10.90	0.421	0.429
F5	3.65	3.85	0.144	0.152
F6	1.25	1.45	0.049	0.057

DOCUMENT NO.  
Z8B00003324

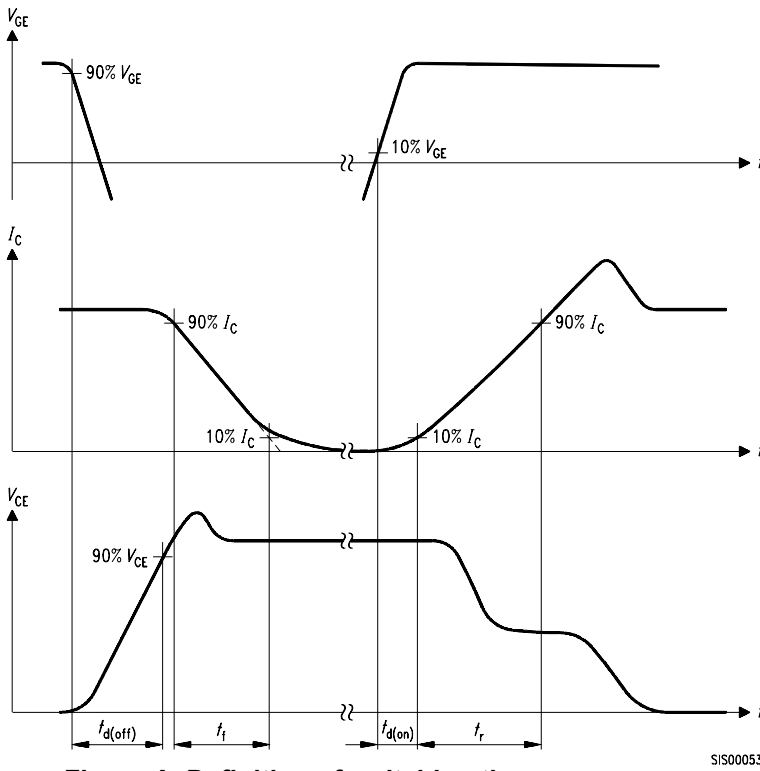
SCALE

7.5mm

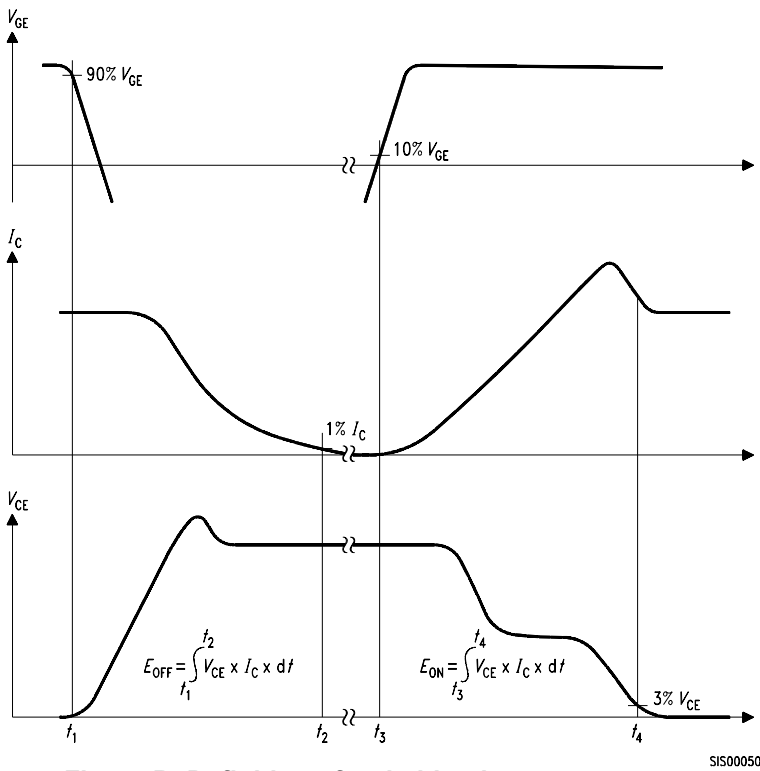
EUROPEAN PROJECTION

ISSUE DATE  
30-08-2007

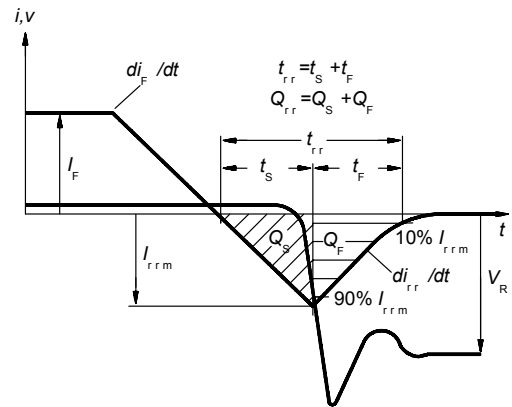
REVISION  
01



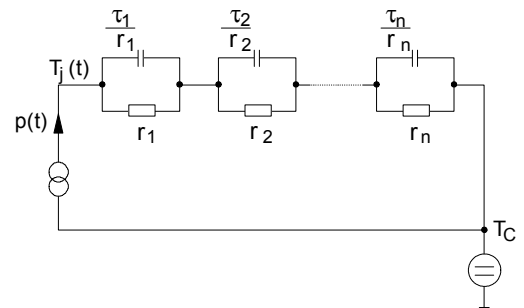
**Figure A. Definition of switching times**



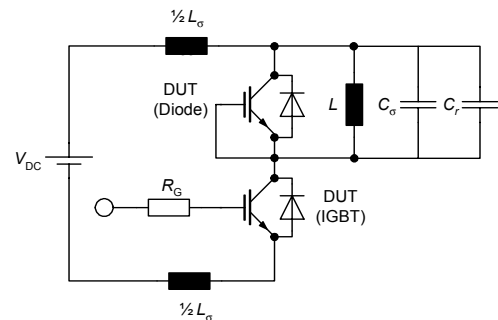
**Figure B. Definition of switching losses**



**Figure C. Definition of diodes switching characteristics**



**Figure D. Thermal equivalent circuit**



**Figure E. Dynamic test circuit**  
 Leakage inductance  $L_\sigma = 180\text{nH}$ ,  
 Stray capacitor  $C_\sigma = 40\text{pF}$ ,  
 Relief capacitor  $C_r = 1\text{nF}$  (only for ZVT switching)

**Edition 2006-01**

**Published by  
Infineon Technologies AG  
81726 München, Germany**

**© Infineon Technologies AG 11/6/07.**

**All Rights Reserved.**

**Attention please!**

The information given in this data sheet shall in no event be regarded as a guarantee of conditions or characteristics ("Beschaffheitsgarantie"). With respect to any examples or hints given herein, any typical values stated herein and/or any information regarding the application of the device, Infineon Technologies hereby disclaims any and all warranties and liabilities of any kind, including without limitation warranties of non-infringement of intellectual property rights of any third party.

**Information**

For further information on technology, delivery terms and conditions and prices please contact your nearest Infineon Technologies Office ([www.infineon.com](http://www.infineon.com)).

**Warnings**

Due to technical requirements components may contain dangerous substances. For information on the types in question please contact your nearest Infineon Technologies Office.

Infineon Technologies Components may only be used in life-support devices or systems with the express written approval of Infineon Technologies, if a failure of such components can reasonably be expected to cause the failure of that life-support device or system, or to affect the safety or effectiveness of that device or system. Life support devices or systems are intended to be implanted in the human body, or to support and/or maintain and sustain and/or protect human life. If they fail, it is reasonable to assume that the health of the user or other persons may be endangered.