

CoolGaN™ Gen2

650 V CoolGaN™ enhancement-mode Power Transistor

Infineon's CoolGaN™ is a highly efficient GaN (gallium nitride) transistor technology for power conversion in the voltage range up to 650 V. With extensive experience on the semiconductor market, Infineon's GaN technology brought the e-mode concept to maturity with end-to-end production in high volumes. The pioneering quality ensures the highest standards and offers the most reliable and performing solution among all GaN HEMTs on the market.

Features

- Enhancement mode transistor - Normally OFF switch
- Ultra fast switching
- No reverse-recovery charge
- Capable of reverse conduction
- Low gate charge, low output charge
- Superior commutation ruggedness
- ESD (HBM/CDM) JEDEC standards

Benefits

- Improves system efficiency
- Improves power density
- Enables highest operating frequency
- System cost reduction savings
- Reduces EMI

Potential applications

Industrial, telecom, datacenter SMPS, charger and adapter based on half-bridge topologies (half-bridge topologies for hard and soft switching such as Totem pole PFC, high frequency LLC).

Product validation

Fully qualified according to JEDEC for Industrial Applications

Please note: Target Datasheet to change without further notice

Table 1 Key Performance Parameters

Parameter	Value	Unit
$V_{DS,max}$	650	V
$R_{DS(on),max}$	42	mΩ
$Q_{g,typ}$	11.0	nC
$I_{D,pulse}$	90	A
$Q_{oss @ 400 V}$	58	nC
Q_{rr}	0	nC

Type/Ordering Code	Package	Marking	Related Links
IGOT65R035D2	PG-DSO-20	65R035D2	see Appendix A

PG-DSO-20

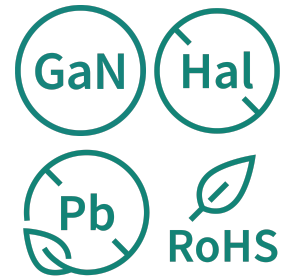
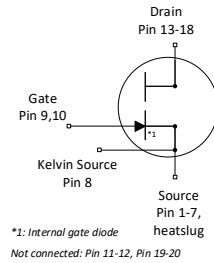
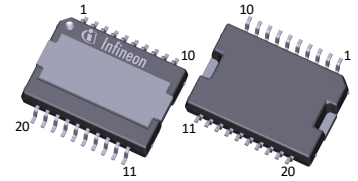



Table of Contents

Description	1
Maximum ratings	3
Thermal characteristics	4
Electrical characteristics	5
Electrical characteristics diagrams	7
Test Circuits	11
Package Outlines	12
Appendix A	13
Revision History	14
Trademarks	14
Disclaimer	14

Datasheet

1 Maximum ratings

at $T_j = 25\text{ °C}$, unless otherwise specified. Stresses beyond max ratings may cause permanent damage to the device. For optimum lifetime and reliability, Infineon recommends operating conditions that do not continuously exceed 80 % of the maximum ratings stated (unless otherwise explicitly stated). For further information, contact your local Infineon sales office.

Table 2 Maximum ratings

Parameter	Symbol	Values			Unit	Note/ Test Condition
		Min.	Typ.	Max.		
Drain source voltage, continuous	$V_{DS,max}$	-	-	650	V	$V_{GS} = 0\text{ V}$, derating recommendation acc. JEDEC JEP198
Leakage current at drain source transient voltage	$I_{DS,trans}$	-	-	20	mA	$V_{GS} = 0\text{ V}$, $V_{DS,trans} = 900\text{ V}$
Drain source voltage transient	$V_{DS,trans}$	-	-	900	V	<1 % duty cycle, <1 μs , 1 M pulses
Drain source voltage, pulsed	$V_{DS,pulse}$ $V_{DS,pulsed}$	-	-	750 650	V	$T_j = 25\text{ °C}$; $V_{GS} \leq 0\text{ V}$; cumulated stress time $\leq 1\text{ h}$ $T_j = 125\text{ °C}$; $V_{GS} \leq 0\text{ V}$; cumulated stress time $\leq 1\text{ h}$
Switching surge voltage, pulsed	$V_{DS,surge}$	-	-	750	V	DC bus voltage = 700 V; turn off $V_{DS,pulse} = 750\text{ V}$; turn on $I_{D,pulse} = 44\text{ A}$; $T_j = 105\text{ °C}$; $f \leq 100\text{ kHz}$, $t \leq 100\text{ sec.}$ (10 million pulses)
Continuous current, drain source ¹⁾	I_D	-	-	44	A	$T_c = 25\text{ °C}$; $T_j = T_{j,max}$
Pulsed current, drain source	$I_{D,pulse}$	-90 -45	-	90 45	A	$T_j = 25\text{ °C}$; $I_G = 42\text{ mA}$; See Diagram 3, 5 $T_j = 125\text{ °C}$; $I_G = 42\text{ mA}$; See Diagram 4, 6
Gate current, continuous ²⁾	$I_{G,avg}$	-	-	32	mA	$T_j = -55\text{ °C}$ to $T_j = 150\text{ °C}$; See Table 9
Gate current, pulsed ²⁾	$I_{G,pulsed}$	-3.2	-	3.2	A	$T_j = -55\text{ °C}$ to $T_j = 150\text{ °C}$; $t_{PULSE} = 50\text{ ns}$, $f = 100\text{ kHz}$; See Table 9
Gate source voltage, continuous ²⁾	V_{GS}	-10	-	-	V	$T_j = -55\text{ °C}$ to $T_j = 150\text{ °C}$; See Diagram 12
Gate source voltage, pulsed ²⁾	$V_{GS,pulse}$	-25	-	-	V	$T_j = -55\text{ °C}$ to $T_j = 150\text{ °C}$; $t_{PULSE} = 50\text{ ns}$, $f = 100\text{ kHz}$; open drain
Power dissipation	P_{tot}	-	-	132	W	$T_c = 25\text{ °C}$
Operating junction temperature	T_j	-55	-	150	°C	-
Storage temperature	T_{stg}	-55	-	150	°C	Max shelf life depends on storage conditions
Drain-source voltage slew-rate	dv/dt	-	-	200	V/ns	-

1) Limited by $T_{j,max}$. Maximum Duty Cycle $D = 0.75$

2) We recommend using an advanced driving technique to optimize the device performance. Please see gate drive application note for more details.

2 Thermal characteristics

Table 3 Thermal characteristics

Parameter	Symbol	Values			Unit	Note/ Test Condition
		Min.	Typ.	Max.		
Thermal resistance, junction - case	R_{thJC}	-	-	0.95	°C/W	-
Thermal resistance, junction - ambient	R_{thJA}	-	-	70	°C/W	Device on PCB, minimum footprint
Thermal resistance, junction - ambient for SMD version	R_{thJA}	-	-	61	°C/W	Device on 40 mm*40 mm*1.5 mm epoxy PCB FR4 with 6 cm ² (one layer, 70 μm thickness) copper area. PCB is vertical without air stream cooling.
Reflow soldering temperature	T_{solder}	-	-	260	°C	reflow MSL3

3 Electrical characteristics

at $T_j=25\text{ °C}$, unless specified otherwise

Table 4 Static characteristics

Parameter	Symbol	Values			Unit	Note/ Test Condition
		Min.	Typ.	Max.		
Gate threshold voltage	$V_{GS(th)}$	0.9 -	1.2 1	1.6 -	V	$I_{DS}=4.2\text{ mA}$; $V_{DS}=10\text{ V}$; $T_j=25\text{ °C}$ $I_{DS}=4.2\text{ mA}$; $V_{DS}=10\text{ V}$; $T_j=150\text{ °C}$
Gate-Source reverse clamping voltage	$V_{GS, clamp}$	-	-	-8	V	$I_{GS}=-1\text{ mA}$
Drain-Source leakage current	I_{DSS}	-	1.6 32	160 -	μA	$V_{DS}=650\text{ V}$, $V_{GS}=0\text{ V}$, $T_j=25\text{ °C}$ $V_{DS}=650\text{ V}$, $V_{GS}=0\text{ V}$, $T_j=150\text{ °C}$
Drain-Source on-state resistance	$R_{DS(on)}$	-	0.035 0.075	0.042 -	Ω	$I_G=42\text{ mA}$; $I_D=13\text{ A}$; $T_j=25\text{ °C}$ $I_G=42\text{ mA}$; $I_D=13\text{ A}$; $T_j=150\text{ °C}$
Gate resistance	$R_{G,int}$	-	tbd	-	Ω	LCR impedance measurement; $f=f_{res}$, open drain;

Table 5 Dynamic characteristics

Parameter	Symbol	Values			Unit	Note/ Test Condition
		Min.	Typ.	Max.		
Input capacitance	C_{iss}	-	530	-	pF	$V_{GS}=0\text{ V}$; $V_{DS}=400\text{ V}$, $f=1\text{ MHz}$
Output capacitance	C_{oss}	-	85	-	pF	$V_{GS}=0\text{ V}$, $V_{DS}=400\text{ V}$, $f=1\text{ MHz}$
Reverse Transfer capacitance	C_{rss}	-	1.02	-	pF	$V_{GS}=0\text{ V}$, $V_{DS}=400\text{ V}$, $f=1\text{ MHz}$
Effective output capacitance, energy related ³⁾	$C_{o(er)}$	-	tbd	-	pF	$V_{DS}=0\text{ to }400\text{ V}$
Effective output capacitance, time related ⁴⁾	$C_{o(tr)}$	-	tbd	-	pF	$V_{GS}=0\text{ V}$; $V_{DS}=0\text{ to }400\text{ V}$; $I_D=const$
Output charge	Q_{oss}	-	58	-	nC	$V_{DS}=0\text{ to }400\text{ V}$
Turn-on delay time	$t_{d(on)}$	-	tbd	-	ns	$I_D=13\text{ A}$; $R_{ON}=3.3\text{ Ohm}$; $R_{OFF}=3.3\text{ Ohm}$; $R_{SS}=220\text{ Ohm}$; $C_C=5.3\text{ nF}$; $V_{DRV}=12\text{ V}$; see Table 8
Turn-off delay time	$t_{d(off)}$	-	tbd	-	ns	$I_D=13\text{ A}$; $R_{ON}=3.3\text{ Ohm}$; $R_{OFF}=3.3\text{ Ohm}$; $R_{SS}=220\text{ Ohm}$; $C_C=5.3\text{ nF}$; $V_{DRV}=12\text{ V}$; see Table 8
Rise time	t_r	-	tbd	-	ns	$I_D=13\text{ A}$; $R_{ON}=3.3\text{ Ohm}$; $R_{OFF}=3.3\text{ Ohm}$; $R_{SS}=220\text{ Ohm}$; $C_C=5.3\text{ nF}$; $V_{DRV}=12\text{ V}$; see Table 8
Fall time	t_f	-	tbd	-	ns	$I_D=13\text{ A}$; $R_{ON}=3.3\text{ Ohm}$; $R_{OFF}=3.3\text{ Ohm}$; $R_{SS}=220\text{ Ohm}$; $C_C=5.3\text{ nF}$; $V_{DRV}=12\text{ V}$; see Table 8

- 3) $C_{o(er)}$ is a fixed capacitance that gives the same stored energy as C_{oss} while V_{DS} is rising from 0 to 400 V
 4) $C_{o(tr)}$ is a fixed capacitance that gives the same charging time as C_{oss} while V_{DS} is rising from 0 to 400 V

Table 6 Gate charge characteristics

Parameter	Symbol	Values			Unit	Note/ Test Condition
		Min.	Typ.	Max.		
Gate charge	Q_G	-	11	-	nC	$V_{GS}=0$ to 3 V; $V_{DS}=400$ V, $I_D=13$ A

Table 7 Reverse conduction characteristics

Parameter	Symbol	Values			Unit	Note/ Test Condition
		Min.	Typ.	Max.		
Source-Drain reverse voltage	V_{SD}	-	2.2	2.5	V	$V_{GS}=0$ V; $I_{SD}=13$ A
Pulsed current, reverse	$I_{SD,pulse}$	-	-	90	A	$I_G=42$ mA
Reverse recovery charge ⁵⁾	Q_{rr}	-	0	-	nC	$I_{SD}=13$ A; $V_{DS}=400$ V

- 5) Excluding Q_{oss}

4 Electrical characteristics diagrams

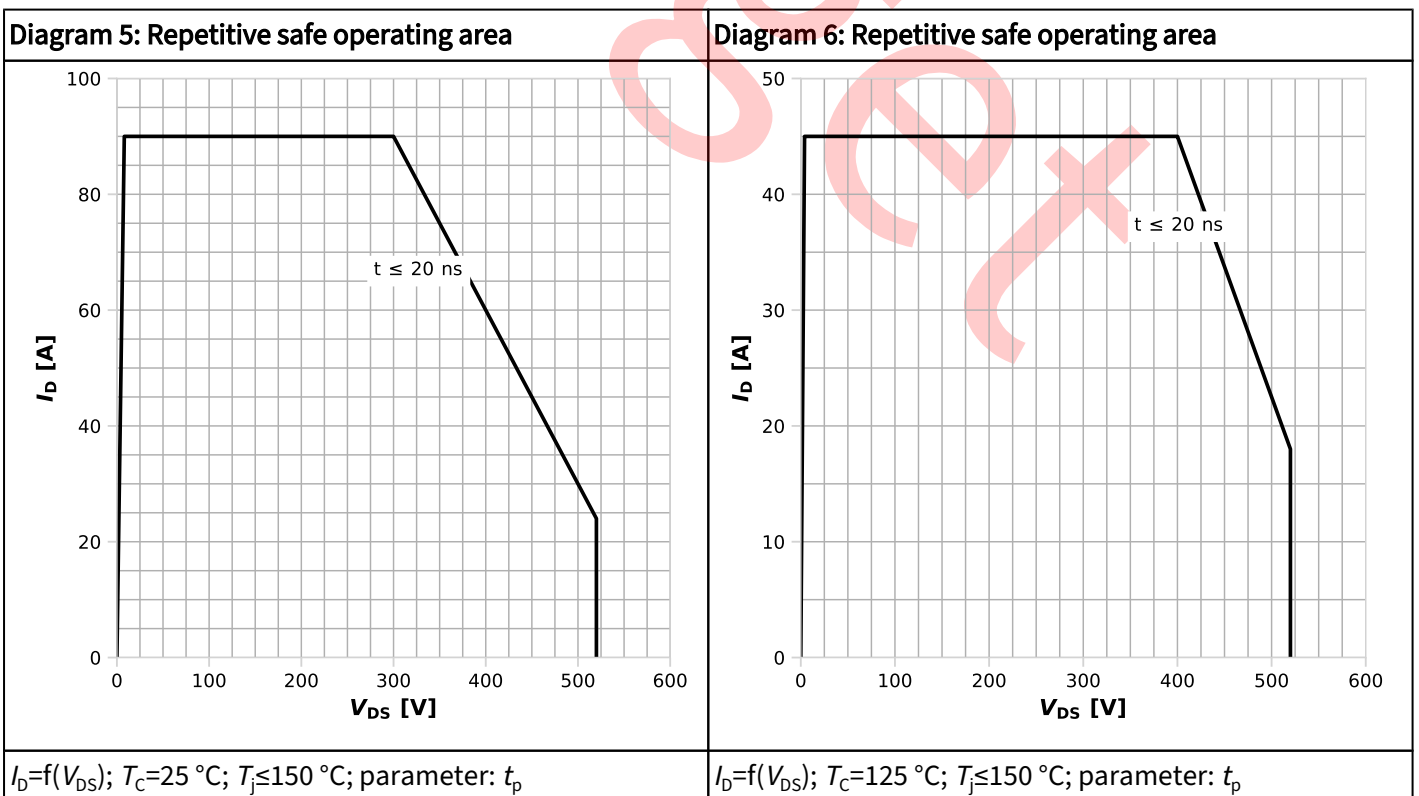
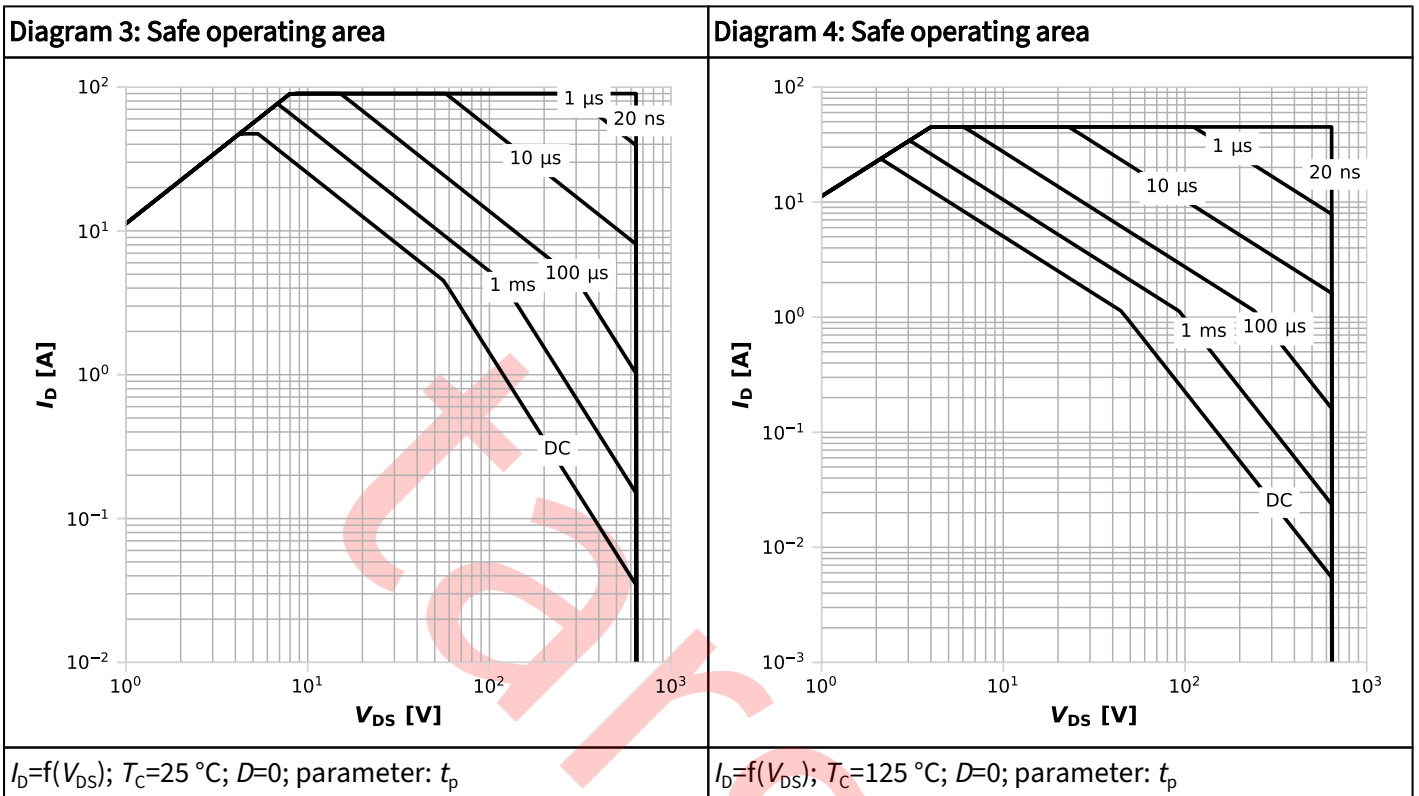
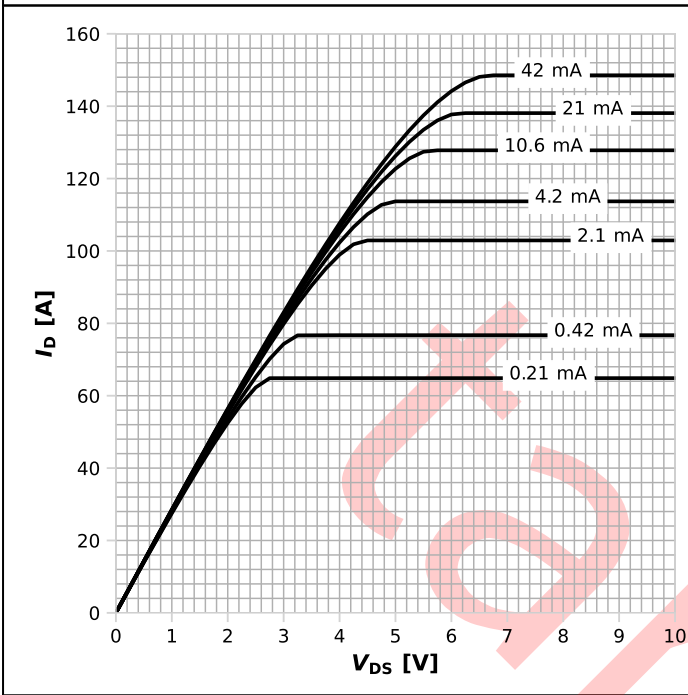
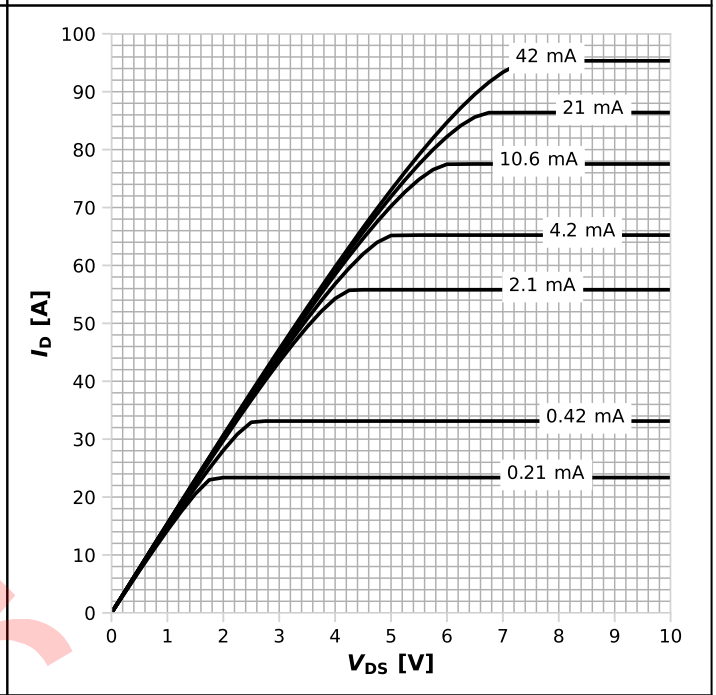

Diagram 7: Typ. output characteristics



$I_D = f(V_{DS}); T_j = 25\text{ °C}; \text{parameter: } I_{GS}$

Diagram 8: Typ. output characteristics



$I_D = f(V_{DS}); T_j = 125\text{ °C}; \text{parameter: } I_{GS}$

Diagram 9: Typ. Drain-source on-state resistance

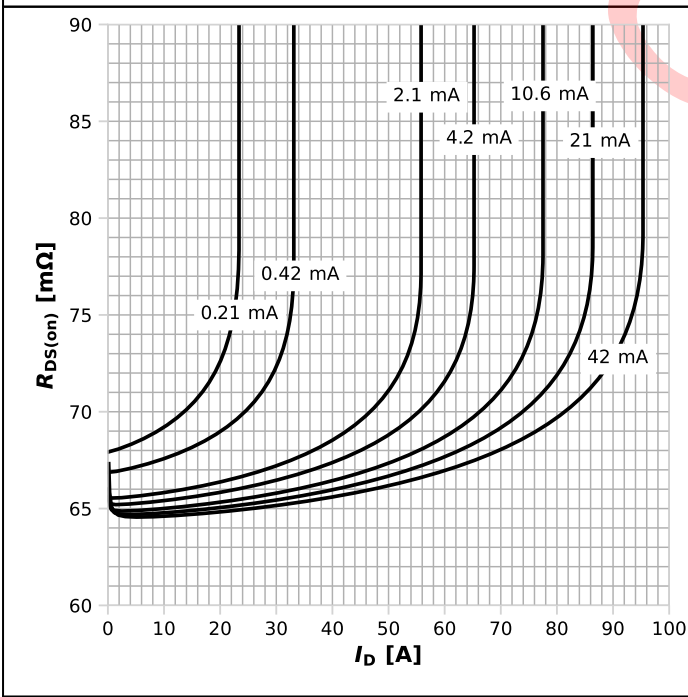

$R_{DS(on)} = f(I_D); T_j = 125\text{ °C}; \text{parameter: } I_{GS}$

Diagram 10: Drain-source on-state resistance

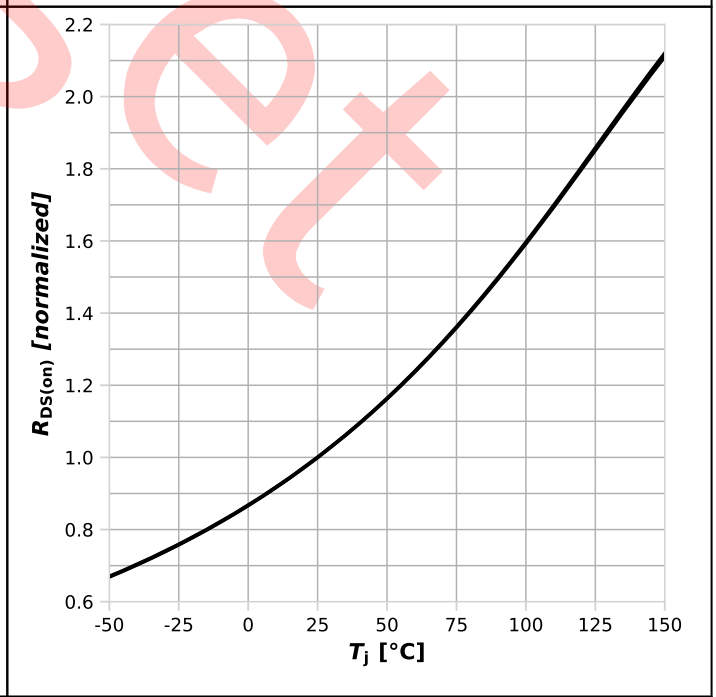

$R_{DS(on)} = f(T_j); I_D = 13\text{ A}$

Diagram 11: Typ. gate characteristics forward

 $I_{GS}=f(V_{GS})$; open drain; parameter: T_j
Diagram 12: Typ. gate characteristics reverse

 $I_{SG}=f(V_{SG})$; parameter: T_j
Diagram 13: Typ. transfer characteristics

 $I_D=f(V_{GS})$; $V_{DS}=8V$; parameter: T_j
Diagram 14: Typ. transfer gate current characteristic

 $I_G=f(V_{GS})$; $V_{DS}=8V$; parameter: T_j

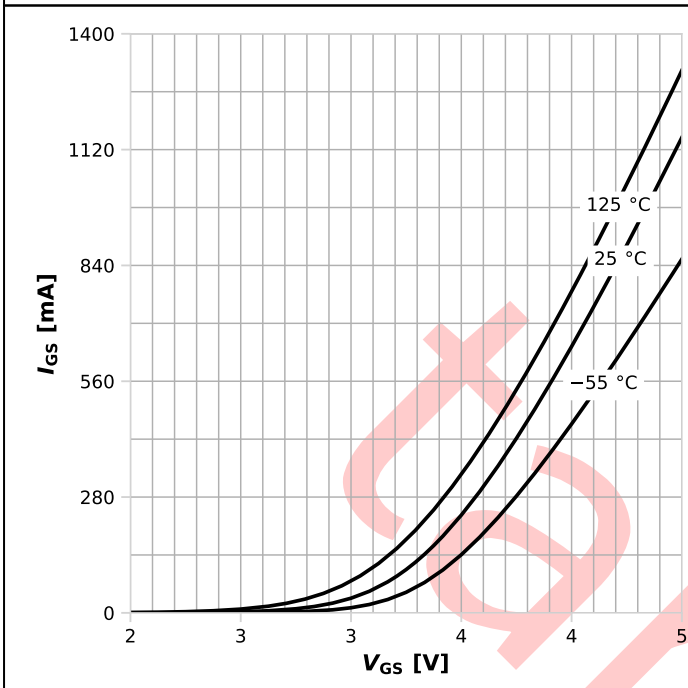
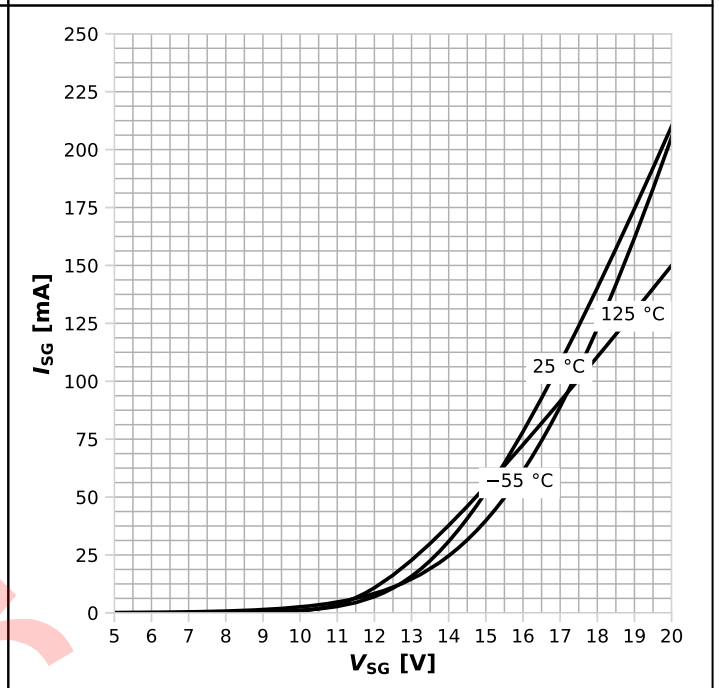
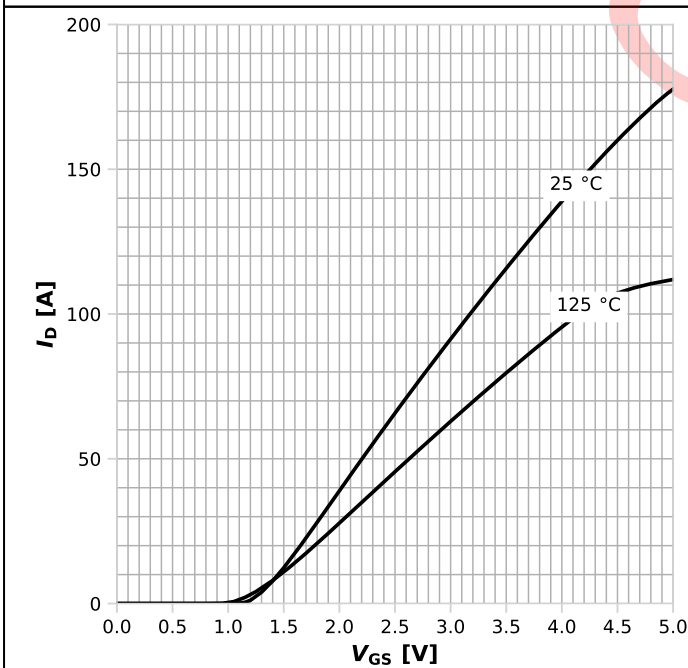
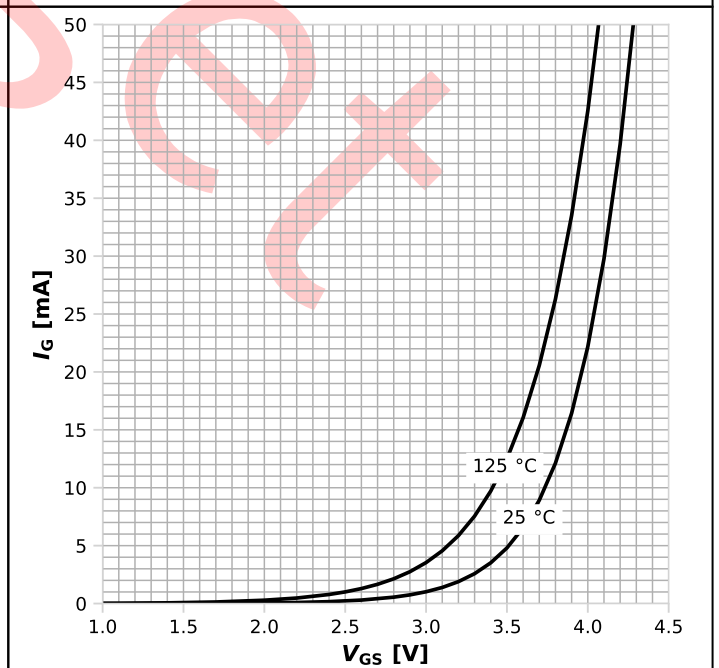
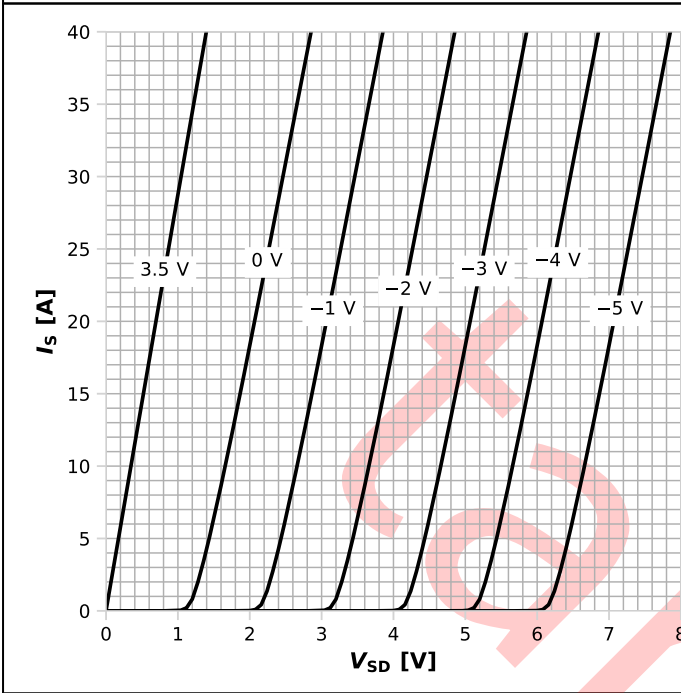
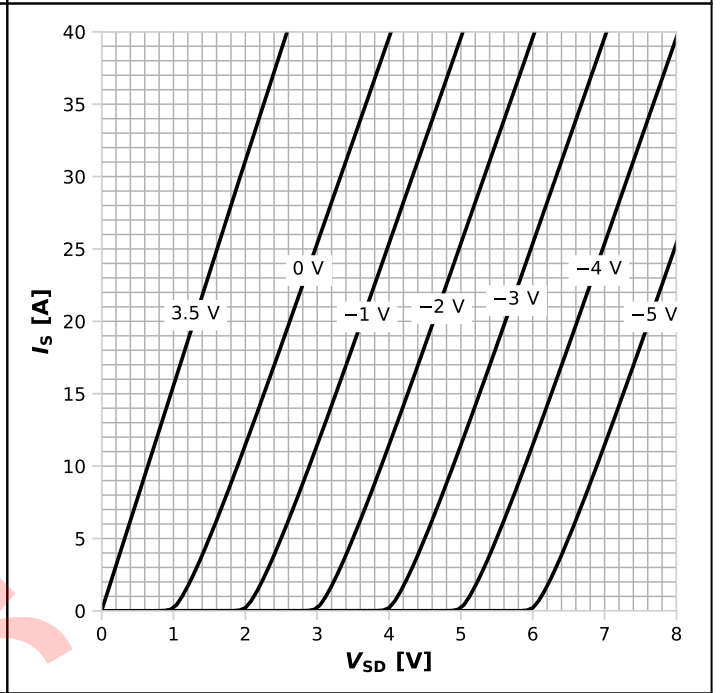
Diagram 15: Typ. channel reverse characteristics



$I_s = f(V_{SD}); T_j = 25\text{ °C}; \text{parameter: } V_{GS}$

Diagram 16: Typ. channel reverse characteristics



$I_s = f(V_{SD}); T_j = 125\text{ °C}; \text{parameter: } V_{GS}$

Diagram 17 Typ. gate charge

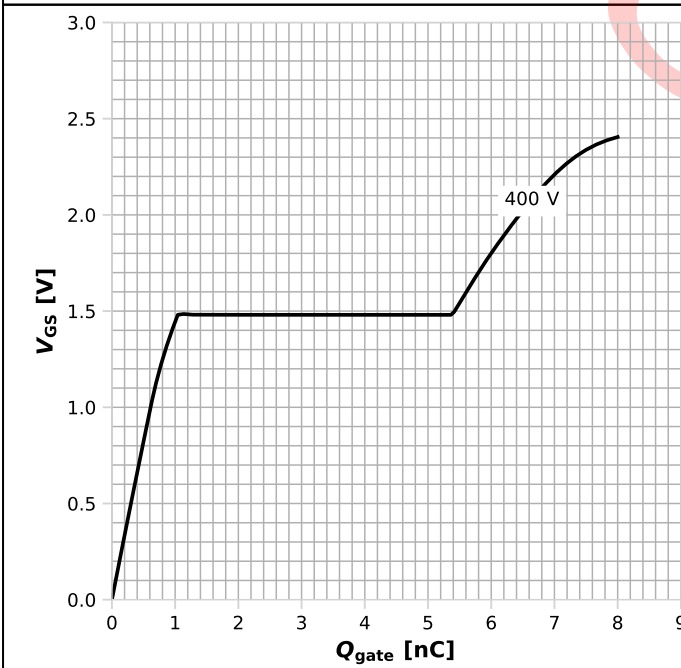

$V_{GS} = f(Q_{gate}); I_D = 13\text{ A pulsed}; \text{parameter: } V_{DD}$

Diagram 18: Typ. capacitances

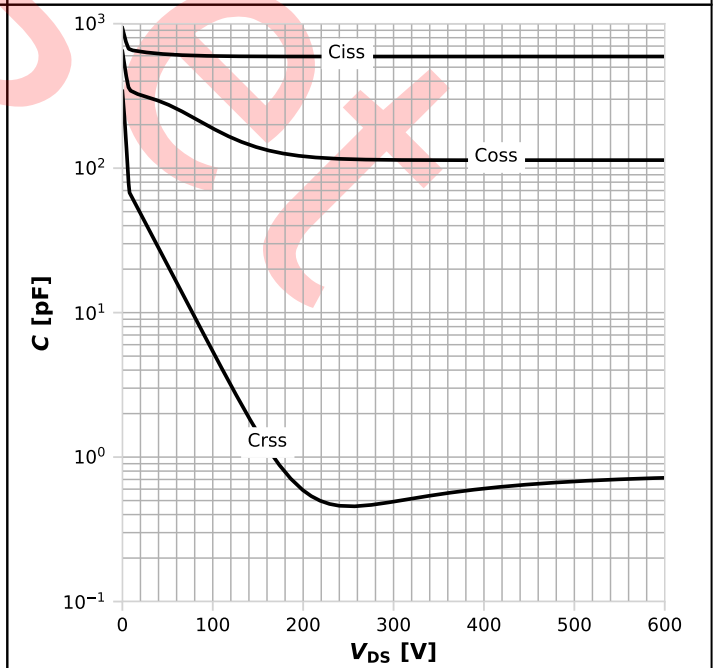

$C = f(V_{DS}); V_{GS} = 0\text{ V}$

5 Test Circuits

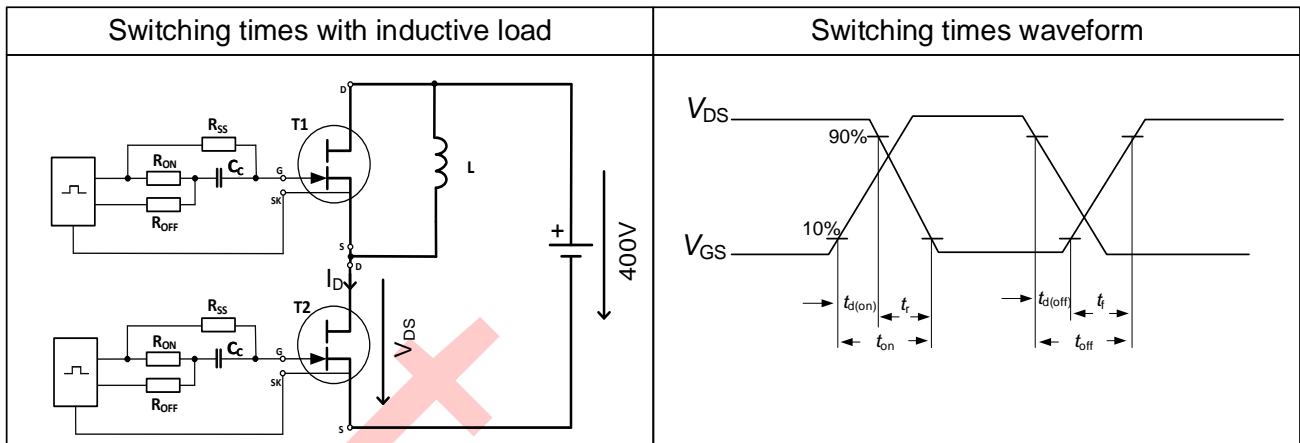
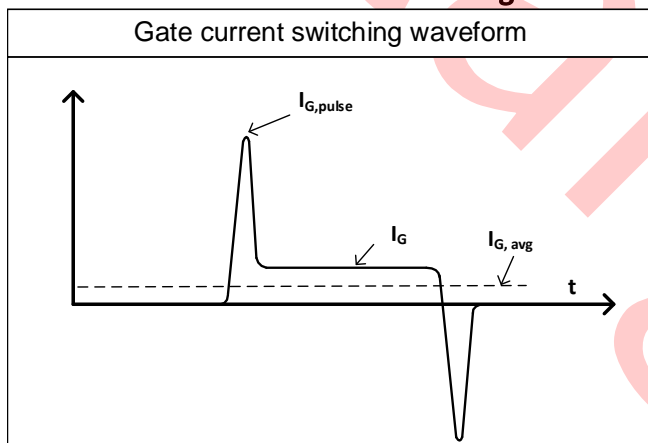
Table 8 Reverse Channel Characteristics Test

Table 9 Gate current switching waveform

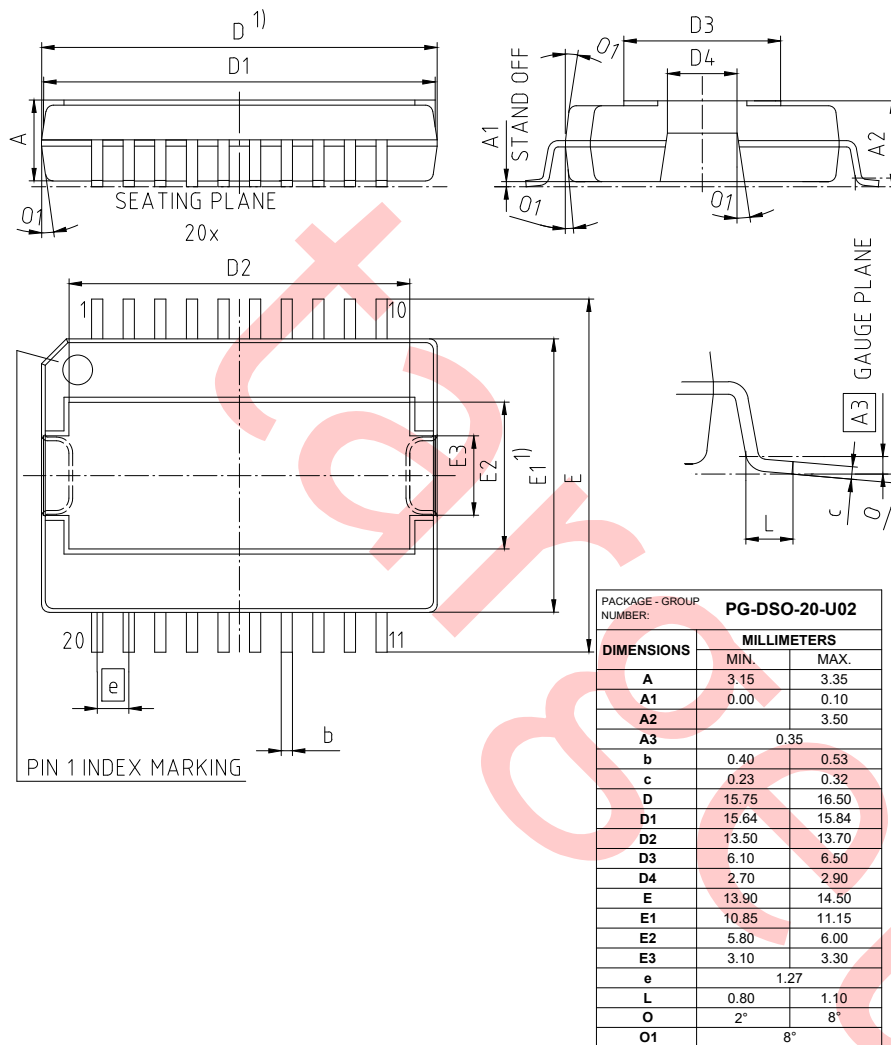
6 Package Outlines



1) DOES NOT INCLUDE PLASTIC OR METAL PRUTRUSION OF 0.15 MAX. PER SIDE

Figure 1 Outline PG-DSO-20, dimensions in mm

7 Appendix A

Table 10 **Related Links**

- [IFX CoolGaN™ GaN 650 V webpage](#)
- [IFX CoolGaN™ GaN 650 V reliability white paper](#)
- [IFX CoolGaN™ GaN 650 V gate driver application note](#)
- [IFX CoolGaN™ GaN 650 V applications information](#)

datasheet

Revision History

IGOT65R035D2

Revision 2024-04-03, Rev. 0.1

Previous Revision

Revision	Date	Subjects (major changes since last revision)
0.1	2024-04-03	Release of target

Trademarks

All referenced product or service names and trademarks are the property of their respective owners.

We Listen to Your Comments Any information within this document that you feel is wrong, unclear or missing at all? Your feedback will help us to continuously improve the quality of this document. Please send your proposal (including a reference to this document) to: erratum@infineon.com

Published by

Infineon Technologies AG
81726 München, Germany
© 2024 Infineon Technologies AG
All Rights Reserved.

Legal Disclaimer

The information given in this document shall in no event be regarded as a guarantee of conditions or characteristics ("Beschaffenheitsgarantie"). With respect to any examples, hints or any typical values stated herein and/or any information regarding the application of the product, Infineon Technologies hereby disclaims any and all warranties and liabilities of any kind, including without limitation warranties of non-infringement of intellectual property rights of any third party.

In addition, any information given in this document is subject to customer's compliance with its obligations stated in this document and any applicable legal requirements, norms and standards concerning customer's products and any use of the product of Infineon Technologies in customer's applications.

The data contained in this document is exclusively intended for technically trained staff. It is the responsibility of customer's technical departments to evaluate the suitability of the product for the intended application and the completeness of the product information given in this document with respect to such application.

Information

For further information on technology, delivery terms and conditions and prices please contact your nearest Infineon Technologies Office (www.infineon.com).

Warnings

Due to technical requirements, components may contain dangerous substances. For information on the types in question, please contact the nearest Infineon Technologies Office.

The Infineon Technologies component described in this Data Sheet may be used in life-support devices or systems and/or automotive, aviation and aerospace applications or systems only with the express written approval of Infineon Technologies, if a failure of such components can reasonably be expected to cause the failure of that life-support, automotive, aviation and aerospace device or system or to affect the safety or effectiveness of that device or system. Life support devices or systems are intended to be implanted in the human body or to support and/or maintain and sustain and/or protect human life. If they fail, it is reasonable to assume that the health of the user or other persons may be endangered.