

Low Loss IGBT : IGBT in TRENCHSTOP™ technology

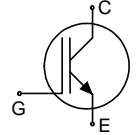

- Very low $V_{CE(sat)}$ 1.5 V (typ.)
- Maximum Junction Temperature 175°C
- Short circuit withstand time 5 μ s
- Designed for :
 - frequency inverters
 - drives
- TRENCHSTOP™ technology for 600V applications offers :
 - very tight parameter distribution
 - high ruggedness, temperature stable behavior
 - very high switching speed
 - low $V_{CE(sat)}$
- Positive temperature coefficient in $V_{CE(sat)}$
- Low EMI
- Low Gate Charge
- Qualified according to JEDEC¹ for target applications
- Complete product spectrum and PSpice Models : <http://www.infineon.com/igbt/>

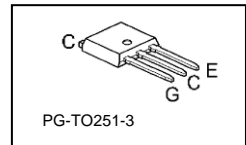

| Type | V_{CE} | I_C | $V_{CE(sat), T_j=25^\circ C}$ | $T_{j,max}$ | Marking | Package |
|-----------|----------|-------|-------------------------------|-------------|---------|------------|
| IGU04N60T | 600 V | 4 A | 1.5 V | 175 °C | G04T60 | PG-TO251-3 |

Maximum Ratings

| Parameter | Symbol | Value | Unit |
|--|--------------|------------|------------|
| Collector-emitter voltage | V_{CE} | 600 | V |
| DC collector current, limited by $T_{j,max}$ $T_C = 25^\circ C$ $T_C = 100^\circ C$ | I_C | 9.5 6.5 | A |
| Pulsed collector current, t_p limited by $T_{j,max}$ | $I_{C,puls}$ | 12 | |
| Turn off safe operating area ($V_{CE} \leq 600V, T_j \leq 175^\circ C$) | - | 12 | |
| Gate-emitter voltage | V_{GE} | ± 20 | V |
| Short circuit withstand time ²⁾ $V_{GE} = 15V, V_{CC} \leq 400V, T_j \leq 150^\circ C$ | t_{SC} | 5 | μs |
| Power dissipation $T_C = 25^\circ C$ | P_{tot} | 42 | W |
| Operating junction temperature | T_j | -40...+175 | $^\circ C$ |
| Storage temperature | T_{stg} | -55...+150 | |
| Soldering temperature, wave soldering, 1.6mm (0.063 in.) from case for 10s. | T_s | 260 | $^\circ C$ |

¹ J-STD-020 and JESD-022

²⁾ Allowed number of short circuits: <1000; time between short circuits: >1s.

Thermal Resistance

| Parameter | Symbol | Conditions | Max. Value | Unit |
|--|------------|------------|------------|------|
| Characteristic | | | | |
| IGBT thermal resistance, junction – case | R_{thJC} | | 3.5 | K/W |
| Thermal resistance, junction – ambient | R_{thJA} | | 75 | |

Electrical Characteristic, at $T_j = 25\text{ °C}$, unless otherwise specified

| Parameter | Symbol | Conditions | Value | | | Unit |
|--------------------------------------|---------------|---|--------|------------|-----------|---------|
| | | | min. | Typ. | max. | |
| Static Characteristic | | | | | | |
| Collector-emitter breakdown voltage | $V_{(BR)CES}$ | $V_{GE}=0V, I_C=0.2mA$ | 600 | - | - | V |
| Collector-emitter saturation voltage | $V_{CE(sat)}$ | $V_{GE} = 15V, I_C=4A$ $T_j=25\text{ °C}$ $T_j=175\text{ °C}$ | - - | 1.5 1.9 | 2.05 - | |
| Gate-emitter threshold voltage | $V_{GE(th)}$ | $I_C = 60\mu A, V_{CE} = V_{GE}$ | 4.1 | 4.9 | 5.7 | |
| Zero gate voltage collector current | I_{CES} | $V_{CE}=600V, V_{GE}=0V$ $T_j=25\text{ °C}$ $T_j=175\text{ °C}$ | - - | - 40 | 40 - | μA |
| Gate-emitter leakage current | I_{GES} | $V_{CE}=0V, V_{GE}=20V$ | - | - | 100 | |
| Transconductance | g_{fs} | $V_{CE}=20V, I_C=4A$ | - | 2.2 | - | S |

Dynamic Characteristic

| | | | | | | |
|--|-------------|--|---|-----|---|----|
| Input capacitance | C_{iss} | $V_{CE}=25V, V_{GE}=0V, f=1MHz$ | - | 252 | - | pF |
| Output capacitance | C_{oss} | | - | 20 | - | |
| Reverse transfer capacitance | C_{riss} | | - | 7.5 | - | |
| Gate charge | Q_{Gate} | $V_{CC}=480V, I_C=4A, V_{GE}=15V$ | - | 27 | - | nC |
| Internal emitter inductance measured 5mm (0.197 in.) from case | L_E | | - | 7 | - | nH |
| Short circuit collector current ¹⁾ | $I_{C(SC)}$ | $V_{GE}=15V, t_{SC}\leq 5\mu s, V_{CC} = 400V, T_j \leq 150\text{ °C}$ | - | 36 | - | A |

¹⁾ Allowed number of short circuits: <1000; time between short circuits: >1s.

Switching Characteristic, Inductive Load, at $T_j=25^\circ\text{C}$

| Parameter | Symbol | Conditions | Value | | | Unit |
|----------------------------|--------------|--|-------|------|------|---------------|
| | | | min. | Typ. | max. | |
| IGBT Characteristic | | | | | | |
| Turn-on delay time | $t_{d(on)}$ | $T_j=25^\circ\text{C}$, $V_{CC}=400\text{V}$, $I_C=4\text{A}$, $V_{GE}=0/15\text{V}$, $r_G=47\Omega$, $L_\sigma=150\text{nH}$, $C_\sigma=47\text{pF}$ L_σ , C_σ from Fig. E Energy losses include "tail" and diode reverse recovery. | - | 14 | - | ns |
| Rise time | t_r | | - | 7 | - | |
| Turn-off delay time | $t_{d(off)}$ | | - | 164 | - | |
| Fall time | t_f | | - | 43 | - | |
| Turn-on energy | E_{on} | | - | 61 | - | μJ |
| Turn-off energy | E_{off} | | - | 84 | - | |
| Total switching energy | E_{ts} | | - | 145 | - | |

Switching Characteristic, Inductive Load, at $T_j=175^\circ\text{C}$

| Parameter | Symbol | Conditions | Value | | | Unit |
|----------------------------|--------------|---|-------|------|------|---------------|
| | | | min. | Typ. | max. | |
| IGBT Characteristic | | | | | | |
| Turn-on delay time | $t_{d(on)}$ | $T_j=175^\circ\text{C}$, $V_{CC}=400\text{V}$, $I_C=4\text{A}$, $V_{GE}=0/15\text{V}$, $r_G=47\Omega$, $L_\sigma=150\text{nH}$, $C_\sigma=47\text{pF}$ L_σ , C_σ from Fig. E Energy losses include "tail" and diode reverse recovery. | - | 14 | - | ns |
| Rise time | t_r | | - | 10 | - | |
| Turn-off delay time | $t_{d(off)}$ | | - | 185 | - | |
| Fall time | t_f | | - | 83 | - | |
| Turn-on energy | E_{on} | | - | 99 | - | μJ |
| Turn-off energy | E_{off} | | - | 97 | - | |
| Total switching energy | E_{ts} | | - | 196 | - | |

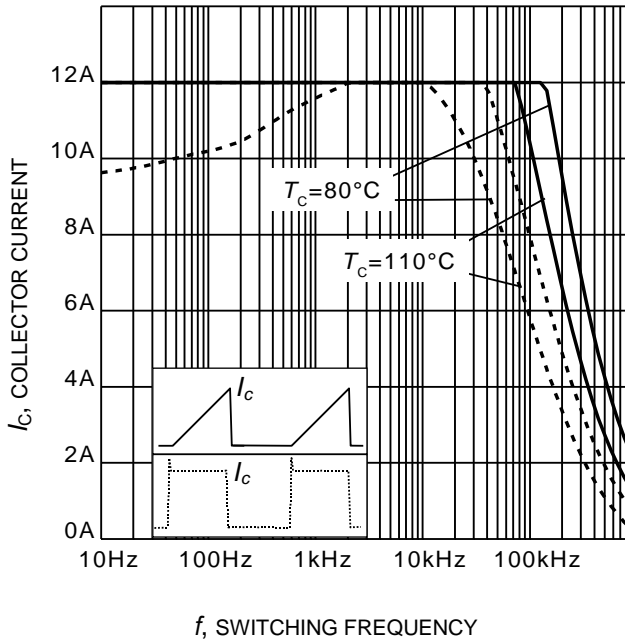

Figure 1. Collector current as a function of switching frequency
 ($T_j \leq 175^\circ\text{C}$, $D = 0.5$, $V_{CE} = 400\text{V}$,
 $V_{GE} = 0/15\text{V}$, $r_G = 47\Omega$)

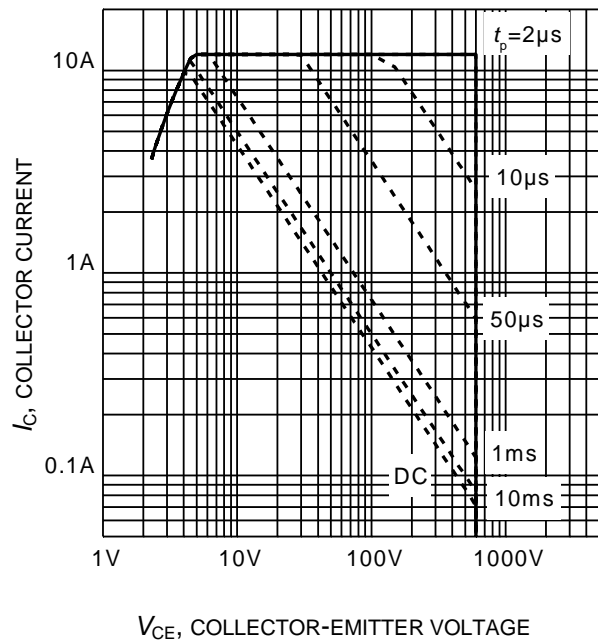

Figure 2. Safe operating area
 ($D = 0$, $T_C = 25^\circ\text{C}$, $T_j \leq 175^\circ\text{C}$;
 $V_{GE} = 0/15\text{V}$)

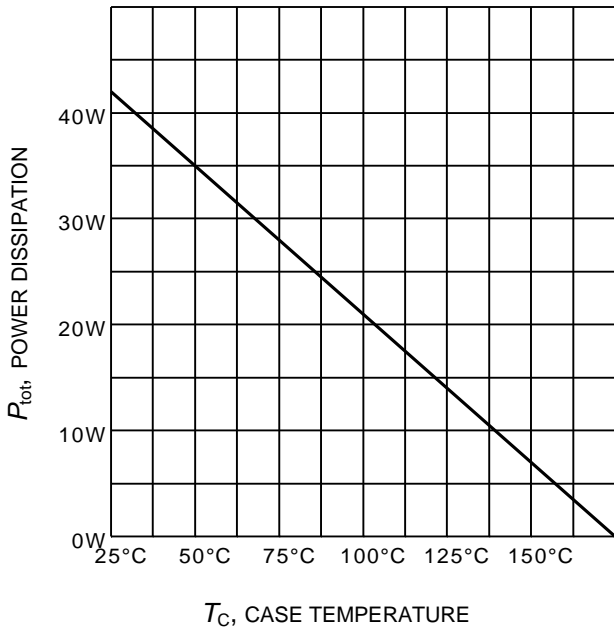

Figure 3. Power dissipation as a function of case temperature
 ($T_j \leq 175^\circ\text{C}$)

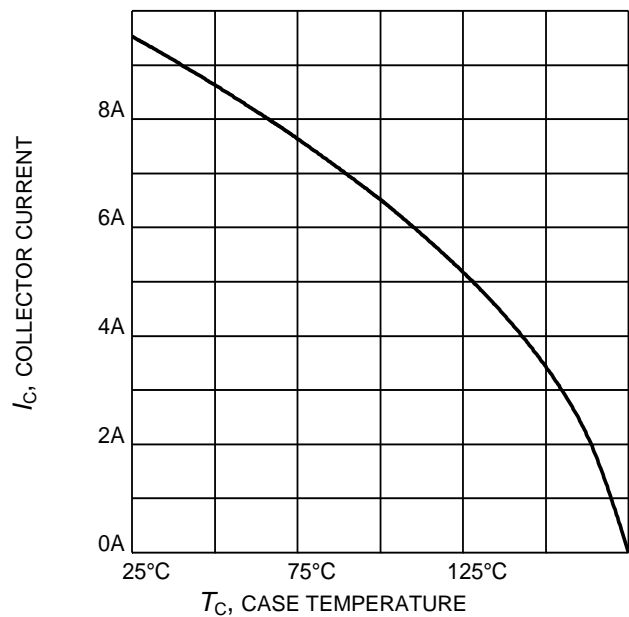

Figure 4. Collector current as a function of case temperature
 ($V_{GE} \geq 15\text{V}$, $T_j \leq 175^\circ\text{C}$)

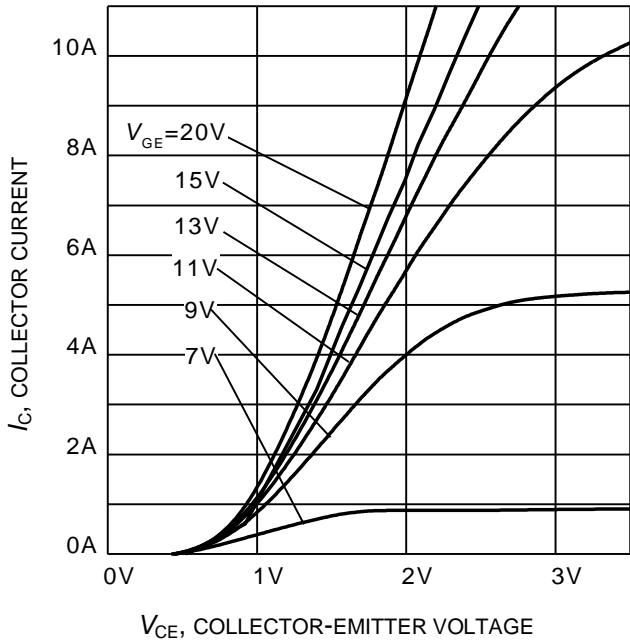

Figure 5. Typical output characteristic
($T_j = 25^\circ\text{C}$)

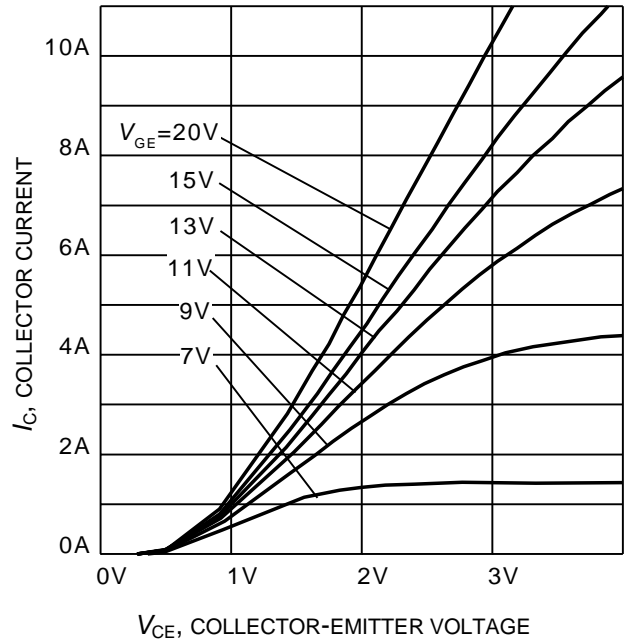

Figure 6. Typical output characteristic
($T_j = 175^\circ\text{C}$)

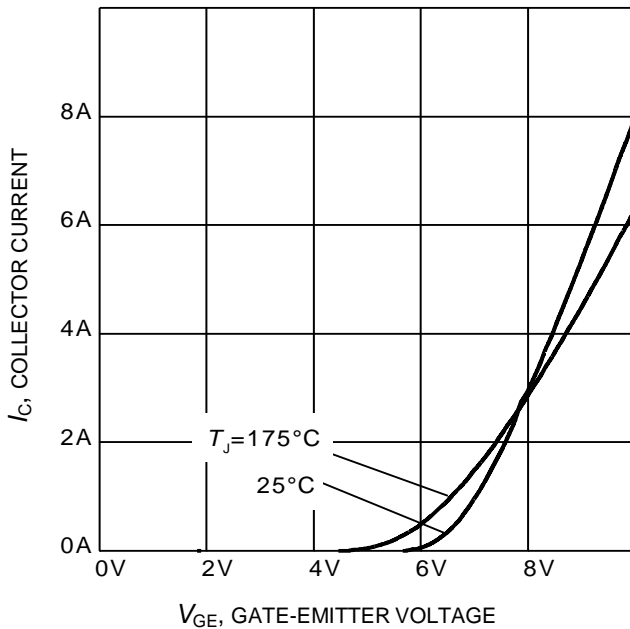

Figure 7. Typical transfer characteristic
($V_{CE} = 20\text{V}$)

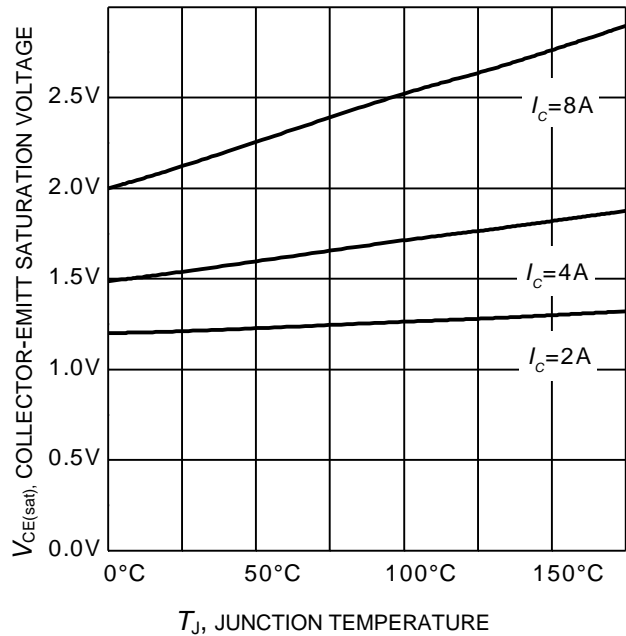

Figure 8. Typical collector-emitter saturation voltage as a function of junction temperature
($V_{GE} = 15\text{V}$)

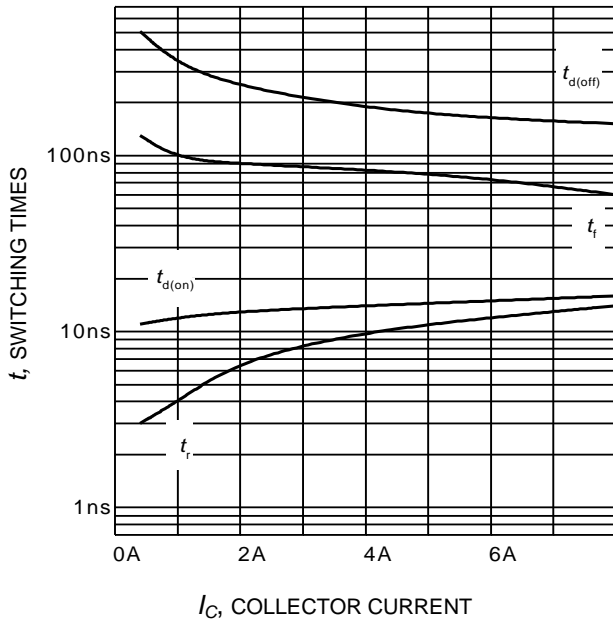

Figure 9. Typical switching times as a function of collector current
 (inductive load, $T_J=175^\circ\text{C}$,
 $V_{CE} = 400\text{V}$, $V_{GE} = 0/15\text{V}$, $r_G = 47\Omega$,
 Dynamic test circuit in Figure E)

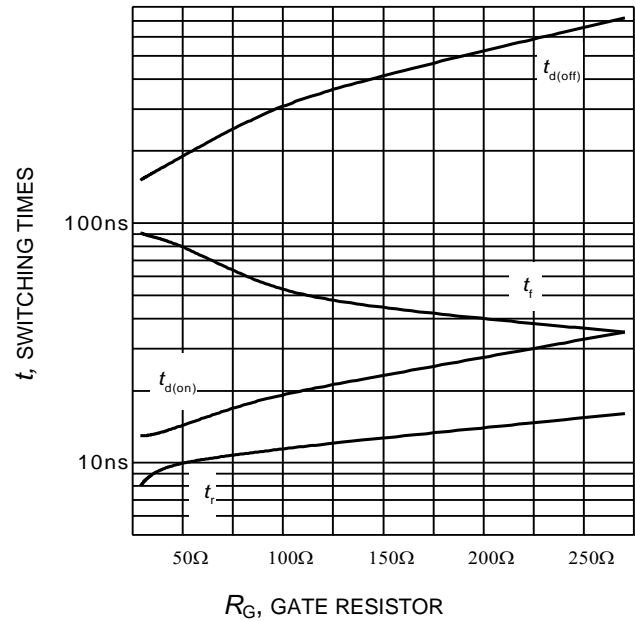

Figure 10. Typical switching times as a function of gate resistor
 (inductive load, $T_J = 175^\circ\text{C}$,
 $V_{CE} = 400\text{V}$, $V_{GE} = 0/15\text{V}$, $I_C = 4\text{A}$,
 Dynamic test circuit in Figure E)

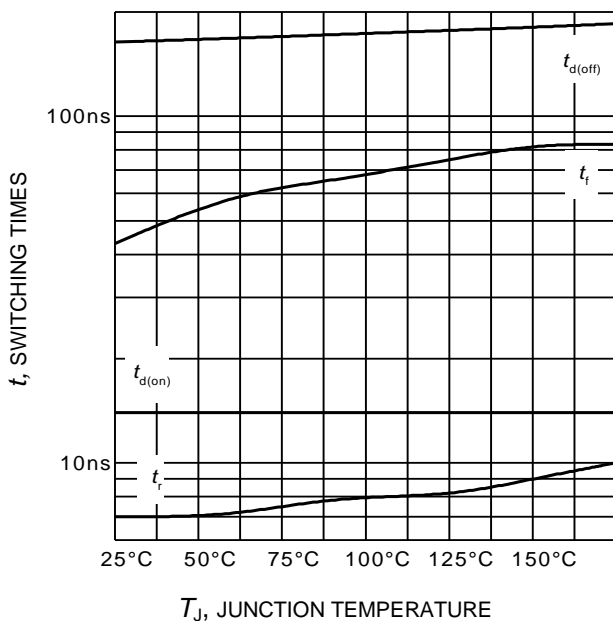

Figure 11. Typical switching times as a function of junction temperature
 (inductive load, $V_{CE} = 400\text{V}$,
 $V_{GE} = 0/15\text{V}$, $I_C = 4\text{A}$, $r_G=47\Omega$,
 Dynamic test circuit in Figure E)

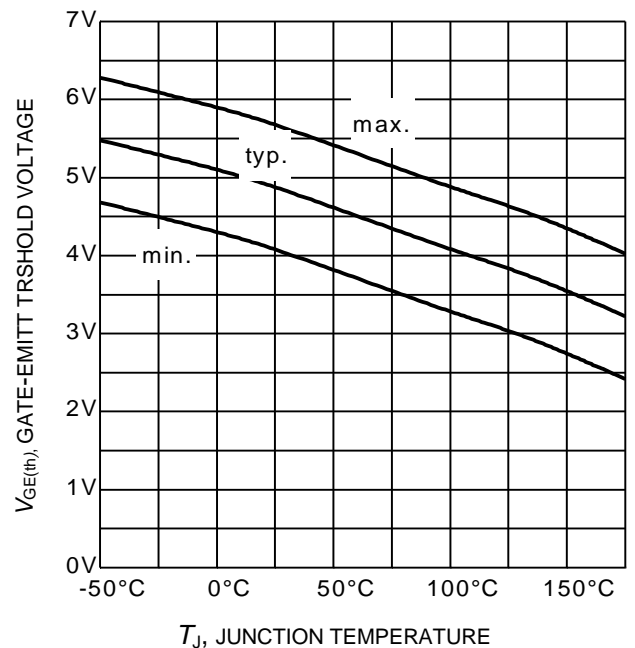

Figure 12. Gate-emitter threshold voltage as a function of junction temperature
 ($I_C = 60\ \mu\text{A}$)

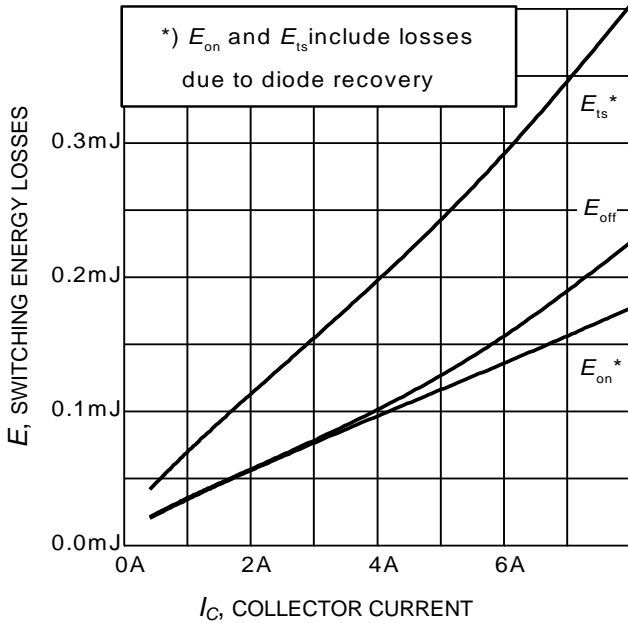

Figure 13. Typical switching energy losses as a function of collector current
 (inductive load, $T_J = 175^\circ\text{C}$,
 $V_{CE} = 400\text{V}$, $V_{GE} = 0/15\text{V}$, $r_G = 47\Omega$,
 Dynamic test circuit in Figure E)

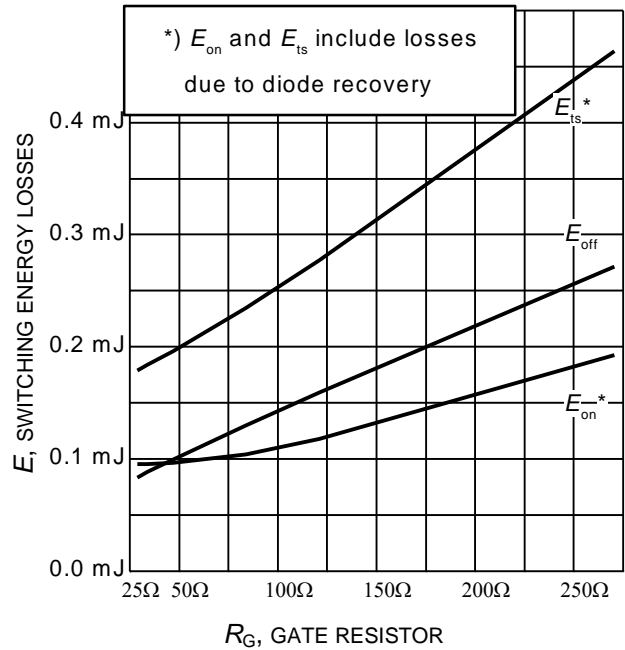

Figure 14. Typical switching energy losses as a function of gate resistor
 (inductive load, $T_J = 175^\circ\text{C}$,
 $V_{CE} = 400\text{V}$, $V_{GE} = 0/15\text{V}$, $I_C = 4\text{A}$,
 Dynamic test circuit in Figure E)

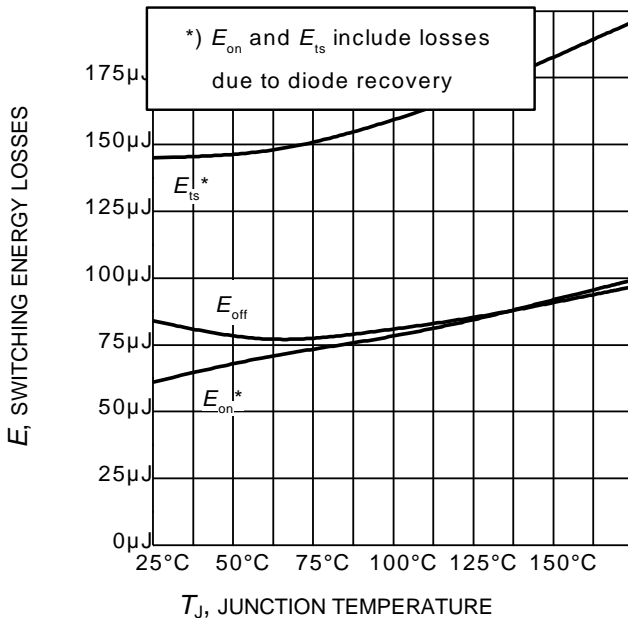

Figure 15. Typical switching energy losses as a function of junction temperature
 (inductive load, $V_{CE} = 400\text{V}$,
 $V_{GE} = 0/15\text{V}$, $I_C = 4\text{A}$, $r_G = 47\Omega$,
 Dynamic test circuit in Figure E)

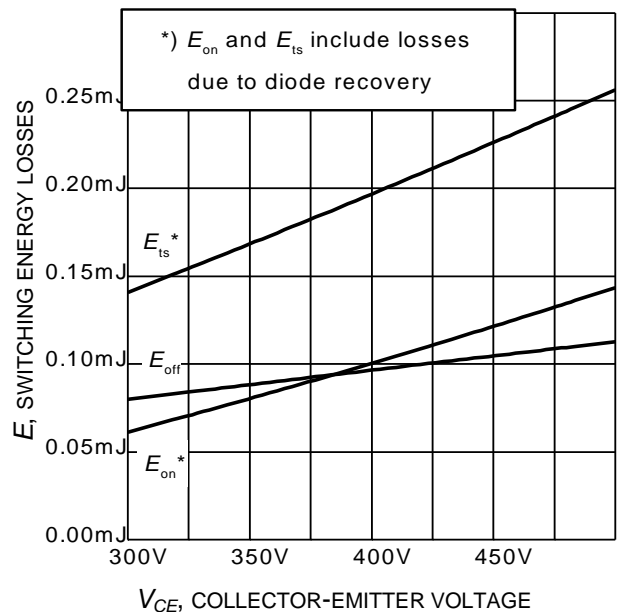

Figure 16. Typical switching energy losses as a function of collector emitter voltage
 (inductive load, $T_J = 175^\circ\text{C}$,
 $V_{GE} = 0/15\text{V}$, $I_C = 4\text{A}$, $r_G = 47\Omega$,
 Dynamic test circuit in Figure E)

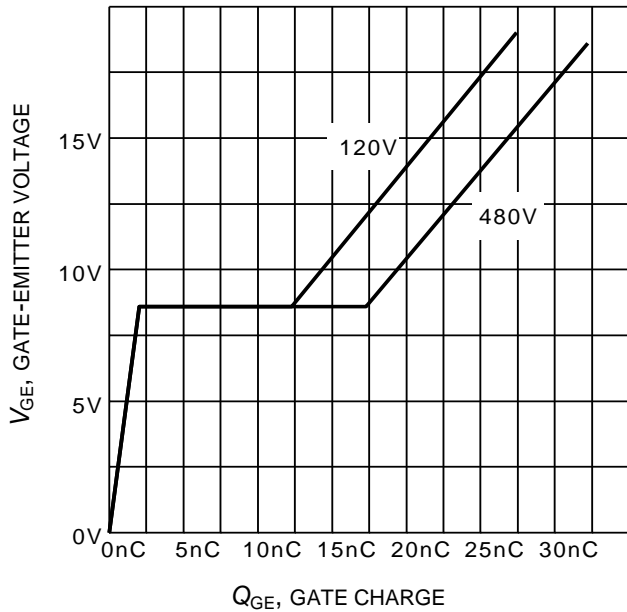

Figure 17. Typical gate charge
($I_C=4\text{ A}$)

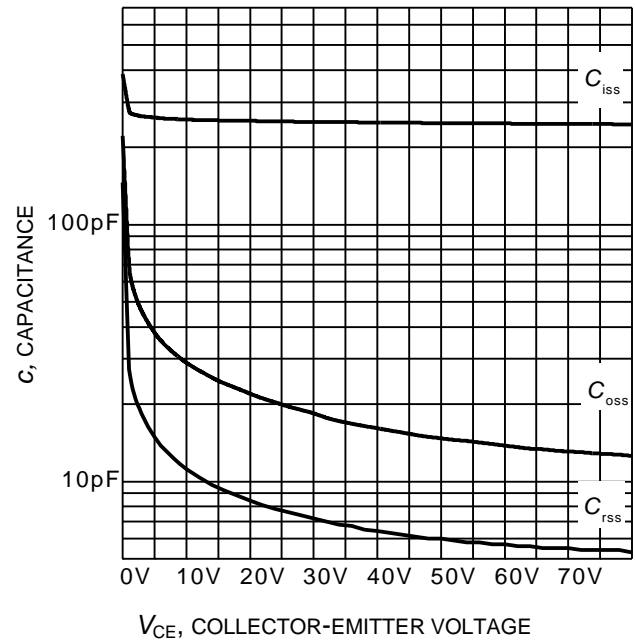

Figure 18. Typical capacitance as a function of collector-emitter voltage
($V_{GE}=0\text{V}$, $f = 1\text{ MHz}$)

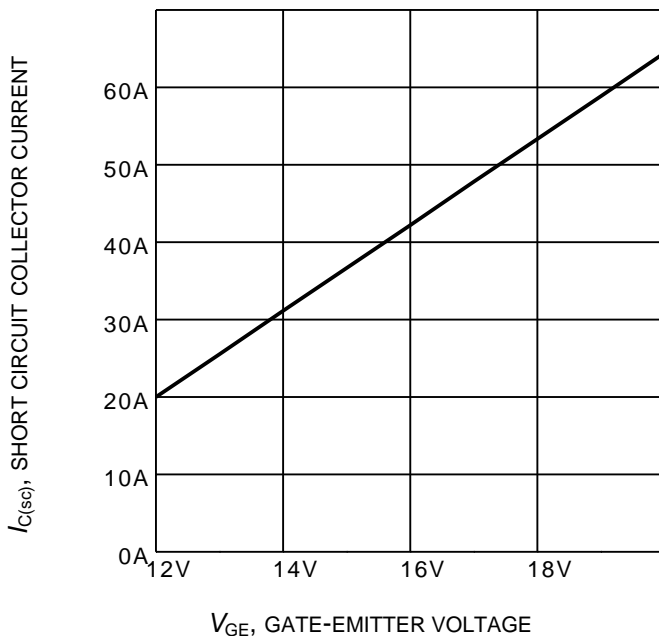

Figure 19. Typical short circuit collector current as a function of gate-emitter voltage
($V_{CE} \leq 400\text{V}$, $T_j \leq 150^\circ\text{C}$)

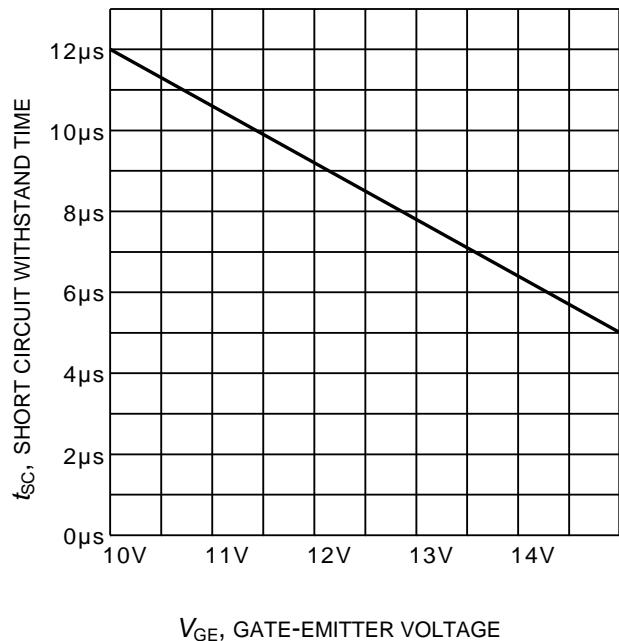

Figure 20. Short circuit withstand time as a function of gate-emitter voltage
($V_{CE}=400\text{V}$, start at $T_j=25^\circ\text{C}$, $T_{j,max}<150^\circ\text{C}$)

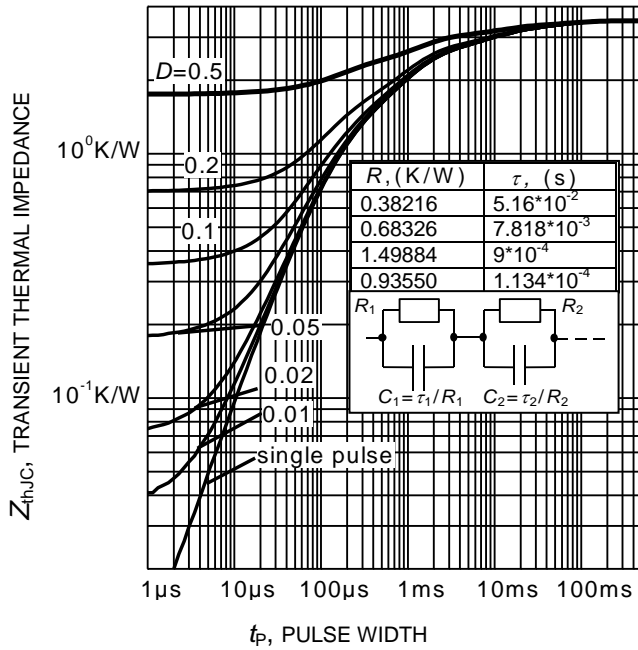
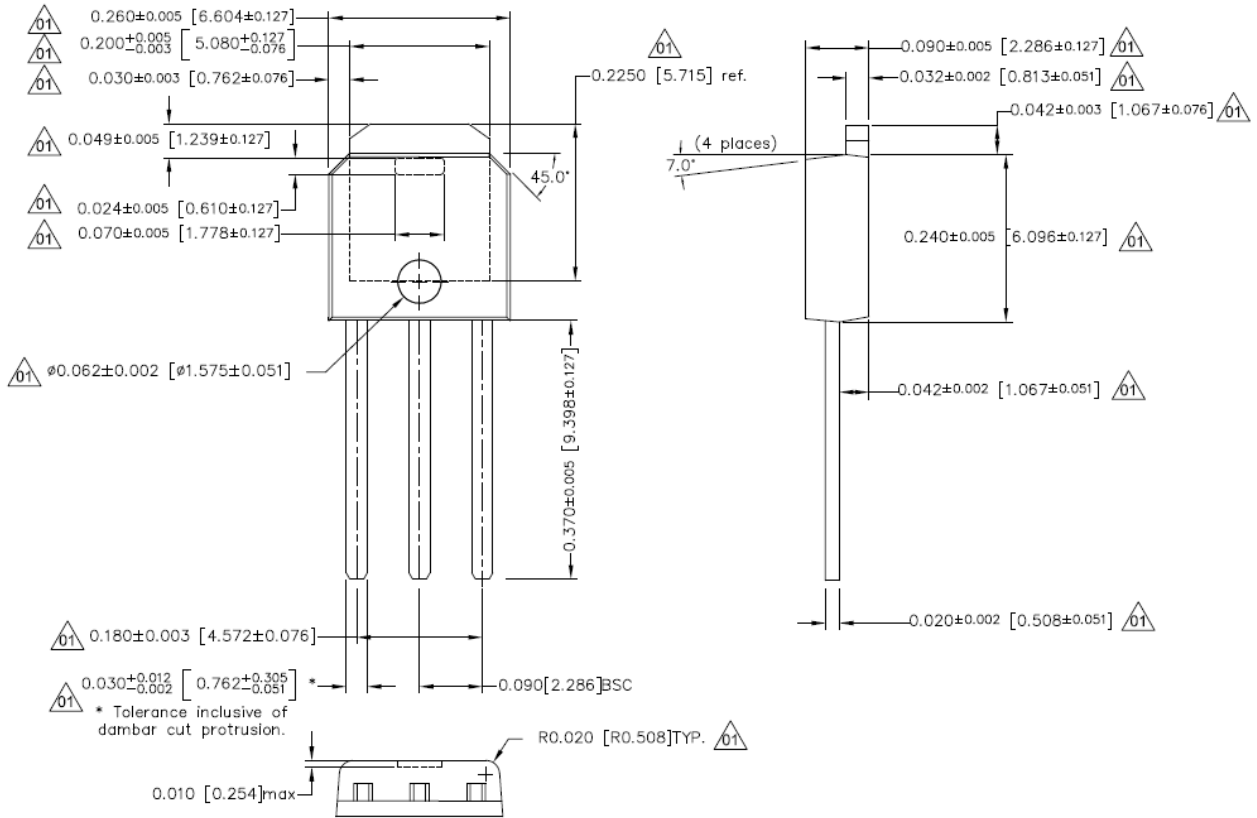

Figure 21. IGBT transient thermal impedance
 $(D = t_p / T)$

PG-TO251-3



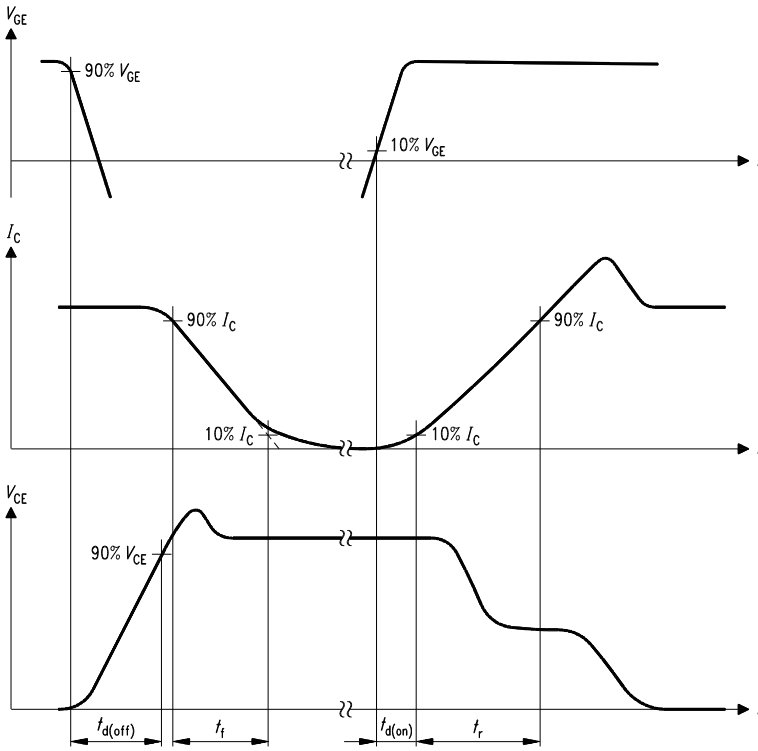

Figure A. Definition of switching times

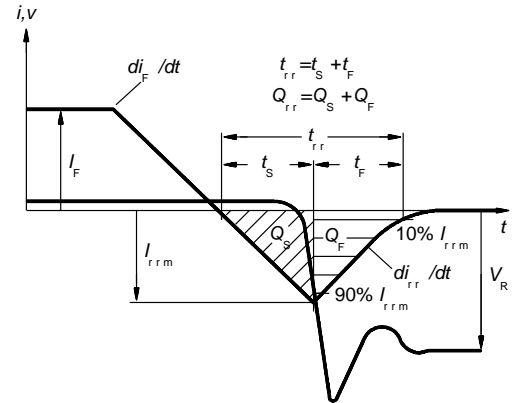

Figure C. Definition of diodes switching characteristics

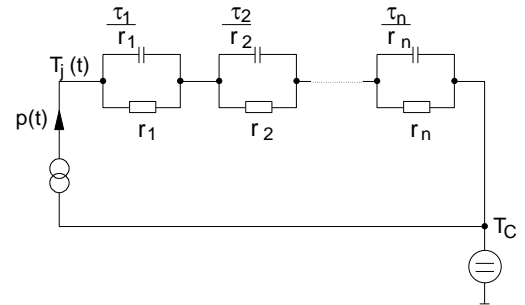

Figure D. Thermal equivalent circuit

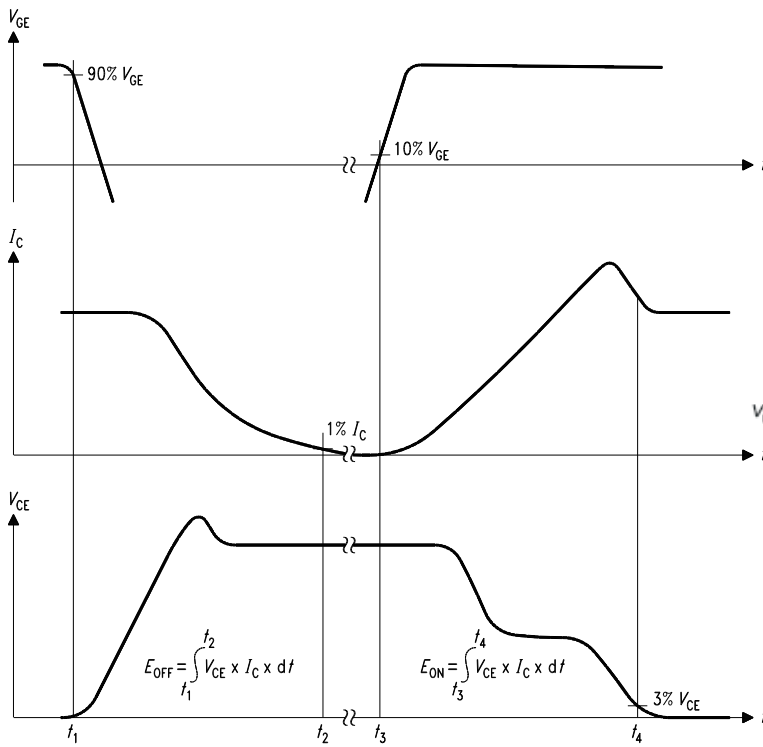

Figure B. Definition of switching losses

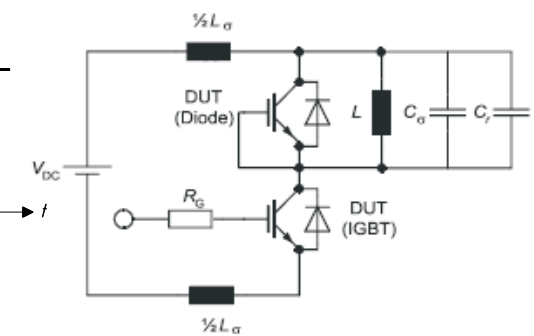

Figure E. Dynamic test circuit
Parasitic inductance L_σ ,
Parasitic capacitor C_σ ,
Relief capacitor C_r
(only for ZVT switching)

Published by
Infineon Technologies AG
81726 München, Germany
© Infineon Technologies AG 2016.
All Rights Reserved.

IMPORTANT NOTICE

The information given in this document shall in no event be regarded as a guarantee of conditions or characteristics ("Beschaffenheitsgarantie"). With respect to any examples, hints or any typical values stated herein and/or any information regarding the application of the product, Infineon Technologies hereby disclaims any and all warranties and liabilities of any kind, including without limitation warranties of non-infringement of intellectual property rights of any third party.

In addition, any information given in this document is subject to customer's compliance with its obligations stated in this document and any applicable legal requirements, norms and standards concerning customer's products and any use of the product of Infineon Technologies in customer's applications.

The data contained in this document is exclusively intended for technically trained staff. It is the responsibility of customer's technical departments to evaluate the suitability of the product for the intended application and the completeness of the product information given in this document with respect to such application.

For further information on the product, technology, delivery terms and conditions and prices please contact your nearest Infineon Technologies office (www.infineon.com).

Please note that this product is not qualified according to the AEC Q100 or AEC Q101 documents of the Automotive Electronics Council.

WARNINGS

Due to technical requirements products may contain dangerous substances. For information on the types in question please contact your nearest Infineon Technologies office.

Except as otherwise explicitly approved by Infineon Technologies in a written document signed by authorized representatives of Infineon Technologies, Infineon Technologies' products may not be used in any applications where a failure of the product or any consequences of the use thereof can reasonably be expected to result in personal injury.