

IH5003/IH5004 2-Channel Drivers with SPST FET Switches (Gate Available)

FEATURES

- Gate Lead Available for Nulling Charge Injection Voltage
- Each Channel Complete—Interfaces With Most Integrated Logic
- Low OFF Power Dissipation, ~ 1 mW
- Switches Analog Signals up to 20 Volts Peak-to-Peak
- Low $r_{DS(ON)}$, 30Ω Max on IH5003

GENERAL DESCRIPTION

These switching circuits contain two channels in one package, each channel consisting of a driver circuit controlling a SPST junction FET switch. The driver interfaces DTL, TTL, or RTL logic signals for multiplexing, commutating,

and D/A converter applications, which permits logic design directly with the switch function. Logic "1" at the input turns the FET switch ON, and logic "0" turns it OFF. The gate lead of the FETs has been brought out to enable the application of a referral resistor for nulling out offset voltage due to charge injection.

PIN CONFIGURATIONS

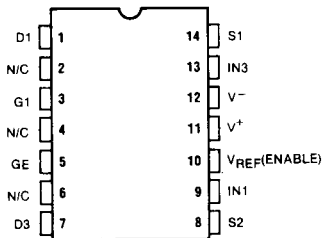

OUTLINE DWGS JD, DD, PD

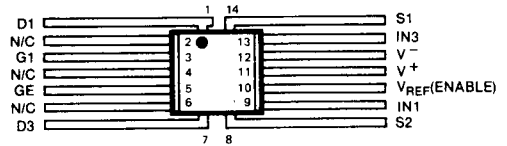

OUTLINE DWG FD-2

SCHEMATIC AND LOGIC DIAGRAMS

IH5003 ($r_{DS(on)} = 30\Omega$)
IH5004 ($r_{DS(on)} = 50\Omega$)

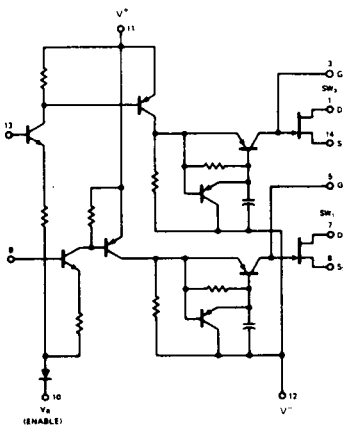

ORDERING INFORMATION

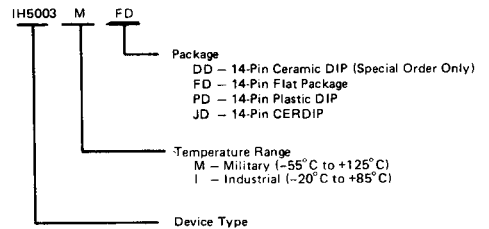

NOTE: Military temperature range not available in plastic package.

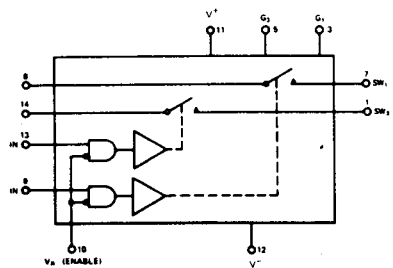

ABSOLUTE MAXIMUM RATINGS

Analog Signal Voltage ($V_A - V^-$ or $V^+ - V_A$)	30V
Total Supply Voltage ($V^+ - V^-$)	36V
Pos. Supply Voltage to Ref. Voltage ($V^+ - V_R$)	25V
Ref. Voltage to Neg. Supply Voltage ($V_R - V^-$)	22V
Power Dissipation (Note)	750 mW
Current (Any Terminal)	30 mA
Storage Temperature	-65 to +150°C
Operating Temperature	-55 to +125°C
Lead Temperature (Soldering, 10 sec)	300°C

NOTE: Dissipation rating assumes device is mounted with all leads welded or soldered to printed circuit board in ambient temperature below 70°C. For higher temperature, derate at rate of 10 mW/°C.

Stresses above those listed under Absolute Maximum Ratings may cause permanent damage to the device. These are stress ratings only, and functional operation of the device at these ratings or under any other conditions above those indicated in the operation sections of the specifications is not implied. Exposure to absolute maximum rating conditions for extended periods may affect device reliability.

ELECTRICAL CHARACTERISTICS

Applied Voltages for all tests: $V^+ = +12V$, $V^- = -18V$, GND = 0. Input test condition which guarantees FET switch ON or OFF as specified is used for output and power supply specifications.

	SYMBOL (NOTE)	CHARACTERISTIC	TYPE	ABSOLUTE MAX LIMIT			UNITS	TEST CONDITIONS
				-55°	25°	125°		
INPUT	$V_{IN(ON)}$	Input Voltage-ON	Both	2.9 min	2.5 min	2.0 min	Volts	$V^- = -12V$
	$V_{IN(OFF)}$	Input Voltage-OFF		1.4	1.0	0.6	Volts	$V^- = -12V$
	$I_{IN(ON)}$	Input Current	Circuits	120	60	60	μA	$V_{IN} = 2.5V$
	$I_{IN(OFF)}$	Input Leakage Current		0.1	0.1	2	μA	$V_{IN} = 0.8V$
SWITCHING	$r_{DS(ON)}$	Drain-Source ON Resistance	IH5003	30	30	50	Ω	$V_D = 10V, I_S = 10 mA$
			IH5004	50	50	85	Ω	
	$I_{D(ON)} + I_{S(ON)}$	Drive Leakage Current	Both Circuits		2	100	nA	$V_D = V_S = -10V$
	$I_{S(OFF)}$	Source Leakage Current		1	100	nA	$V_S = 10V, V_D = -10V$	
$I_{D(OFF)}$	Drain Leakage Current	1		100	nA	$V_D = 10V, V_S = -10V$		
POWER SUPPLY	I^+	Positive Power Supply Drain Current	Both Circuits		3		mA	One Driver ON, $V_{IN} = 2.5V$
	I^-	Negative Power Supply Drain Current			-1.8		mA	
	I_{REF}	Reference Power Supply Drain Current			-1.4		mA	
	I^+_{LK}	Positive Power Supply Leakage Current			25		μA	Both Drivers OFF $V_{IN} = 0.8V$
	I^-_{LK}	Negative Power Supply Leakage Current			-25		μA	
	I_{RLK}	Reference Power Supply Leakage Current			-25		μA	
TIMING	t_{on}	Turn-ON Time	Both		0.3	0.5	μs	See Below
	t_{off}	Turn-OFF Time	Circuits		0.8	1.2	μs	
POWER	P_{ON}	ON Driver Power	Both		175		mW	Both Inputs $V_{IN} = 2.5$
	P_{OFF}	OFF Driver Power	Circuits		1		mW	Both Inputs $V_{IN} = 1V$
FET	$V_{GS(f)}$	Gate Source Forward Voltage	Both Circuits		1.5		Volts	$I_G = 1.0 mA, V_{DS} = 0$

NOTE: (OFF) and (ON) subscript notation refers to the conduction state of the FET switch for the given test.

SWITCHING TIMES (at 25°C)

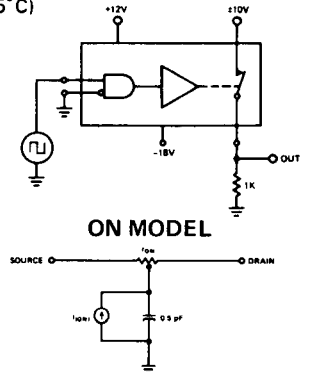
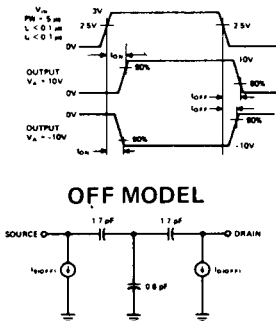

3