

8CH Darlington Sink Driver

IK62083/4

The IK62083~IK62084 are high-voltage, high-current darlington drivers comprised of eight NPN darlington pairs.

All units feature integral clamp diodes for switching inductive loads.

Application include relay, hammer, lamp and display (LED) drivers.

Features

- Output current (single output)
500mA (Max)
- Output clamp diodes
- Inputs compatible with various types of logic

| TYPE | INPUT BASE RESISTOR | DESIGNATION |
|-------------|---------------------|------------------|
| IK62083N/DW | 2.7kΩ | TTL, 5V CMOS |
| IK62084N/DW | 10.5kΩ | 6~15V PMOS, CMOS |

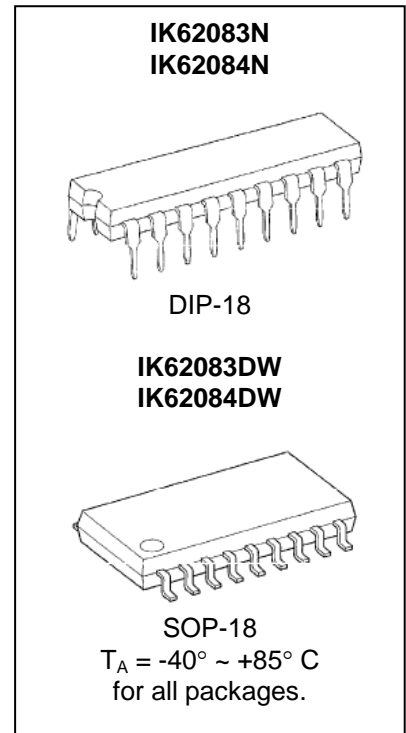

Pin Configuration (top view)

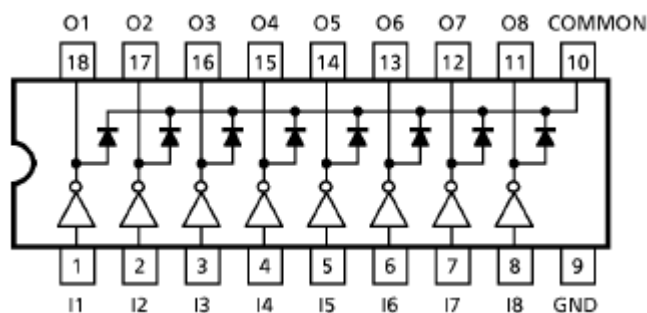

Block Schematics

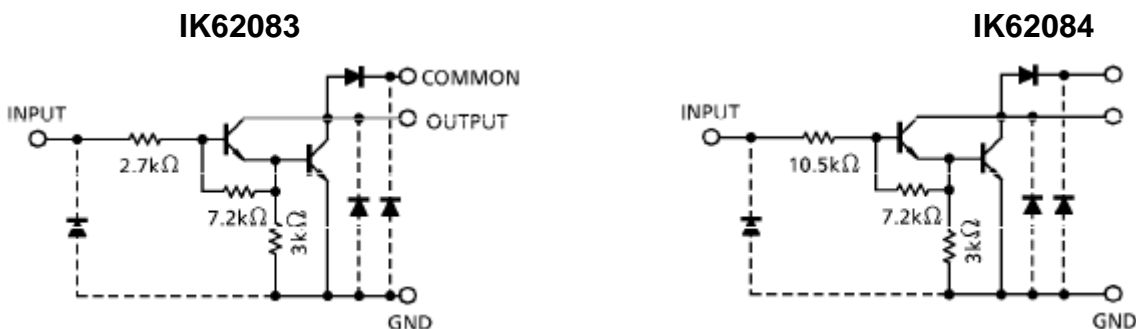

Note: The input and output parasitic diodes cannot be used as clamp diodes.

Maximum Ratings

Ta =25°C

| Parameter | Symbol | Limit Values | | Unit | |
|-----------------------------|----------------------|----------------|------|-------|---|
| | | min. | max. | | |
| Output Sustaining Voltage | V _{CE(SUS)} | -0.5 | 50 | V | |
| Output Current | I _{OUT} | 500 | | mA/ch | |
| Input Voltage | V _{IN} | - 0.5 | 30 | V | |
| Clamp Diode Reverse Voltage | V _R | 50 | | V | |
| Clamp Diode Forward Current | I _F | 500 | | mA | |
| Power Dissipation | IK62083N | P _D | | 1.47 | W |
| | IK62083DW | | | 0.96 | |
| Operating Temperature | T _{opr} | -40 | 85 | °C | |
| Storage Temperature | T _{stg} | -55 | 150 | °C | |

* Stresses beyond those listed under “absolute maximum ratings” may cause permanent damage to the device. These are stress ratings only and functional operation of the device at these or any other conditions beyond those indicated under “recommended operating conditions” is not implied. Exposure to absolute-maximum-rated conditions for extended periods may affect device reliability.

Recommended Operating Conditions

(Ta=-40~85°C)

| Parameter | Symbol | Test Condition | Limit Value | | | Unit | |
|------------------------------|----------------------|---|---|-----|-----|------|-------|
| | | | Min | Typ | Max | | |
| Output Sustaining Voltage | V _{CE(SUS)} | | 0 | - | 50 | V | |
| Output Current | N | I _{OUT} | T _{pw} =25ms,Duty=10%, 8 Circuits | 0 | - | 347 | mA/ch |
| | | | T _{pw} =25ms,Duty=50%, 8 Circuits | 0 | - | 123 | |
| | DW | T _{pw} =25ms,Duty=10%, 8 Circuits | 0 | - | 268 | | |
| | | T _{pw} =25ms,Duty=50%, 8 Circuits | 0 | - | 90 | | |
| Input Voltage | V _{IN} | | 0 | - | 30 | V | |
| Input Voltage (Output On) | IK62083N/DW | V _{IN(ON)} | | 3.5 | - | 30 | V |
| | IK62084N/DW | | | 8 | - | 30 | |
| Clamp Diode Reverse Voltage | V _R | | - | - | 50 | V | |
| Clamp Diode Forward Current | I _F | | - | - | 400 | mA | |
| Power Dissipation | N | P _D | | - | - | 0.52 | W |
| | DW | | | - | - | 0.4 | |

Electrical Characteristics

Ta = 25°C

| Parameter | | Symbol | Test Circuit | Test Condition | Limit Values | | | Unit | |
|--------------------------------------|---------|----------------------|--------------|---|---------------------|------|------|------|----|
| | | | | | Min | Typ | Max | | |
| Output Leakage Current | IK62083 | I _{CEX} | 1 | V _{CE} =50V | Ta=25°C | - | - | 50 | μA |
| | | | | V _{CE} =50V | Ta=85°C | - | - | 100 | |
| | IK62084 | | | V _{CE} =50V | V _{IN} =1V | - | - | 500 | |
| Collector-Emitter Saturation Voltage | | V _{CE(sat)} | 2 | I _{OUT} =350mA, I _{IN} =500μm | | - | 1.3 | 1.6 | V |
| | | | | I _{OUT} =200mA, I _{IN} =350μm | | - | 1.1 | 1.3 | |
| | | | | I _{OUT} =100mA, I _{IN} =250μm | | - | 0.9 | 1.1 | |
| Input Current | IK62083 | I _{IN(ON)} | 2 | V _{IN} =3.85V | | - | 0.93 | 1.35 | mA |
| | IK62084 | | | V _{IN} =5V | | - | 0.35 | 0.5 | |
| | | | | V _{IN} =12V | | - | 1.0 | 1.45 | |
| Input Voltage (Output On) | IK62083 | V _{IN(ON)} | 5 | V _{CE} =2V, I _{OUT} =200mA | | - | - | 2.4 | V |
| | | | | V _{CE} =2V, I _{OUT} =250mA | | - | - | 2.7 | |
| | | | | V _{CE} =2V, I _{OUT} =300mA | | - | - | 3.0 | |
| | IK62084 | | | V _{CE} =2V, I _{OUT} =125mA | | - | - | 5.0 | |
| | | | | V _{CE} =2V, I _{OUT} =200mA | | - | - | 6.0 | |
| | | | | V _{CE} =2V, I _{OUT} =275mA | | - | - | 7.0 | |
| | | | | V _{CE} =2V, I _{OUT} =350mA | | - | - | 8.0 | |
| DC Current Transfer Ratio | | h _{FE} | 2 | V _{CE} =2V, I _{OUT} =350mA | | 1000 | - | - | |
| Clamp Diode Reverse Current | | I _R | 6 | Ta=25°C (Note) | | - | - | 50 | μA |
| | | | | Ta=85°C (Note) | | - | - | 100 | |
| Clamp Diode Forward Voltage | | V _F | 7 | I _F =350mA | | - | - | 2.0 | V |
| Input Capacitance | | C _{IN} | - | | | - | - | 15 | pF |
| Turn-On Delay | | t _{ON} | 8 | R _L =125Ω, V _{OUT} =50V | | - | 0.1 | - | us |
| Turn-Off Delay | | t _{OFF} | 8 | R _L =125Ω, V _{OUT} =50V | | - | 0.21 | - | us |

Note : V_R=V_RMAX

Test Circuit

1. I_{CEX}

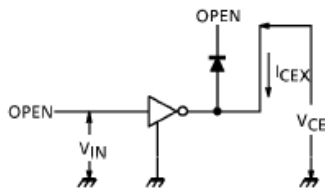

2. $V_{CE(sat)}$, h_{FE}

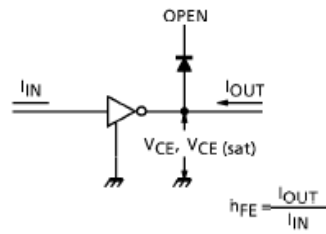

3. $I_{IN(ON)}$

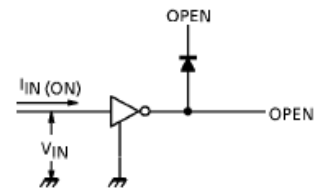

4. $I_{IN(OFF)}$

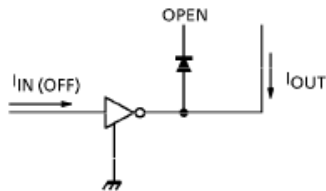

5. $V_{IN(ON)}$

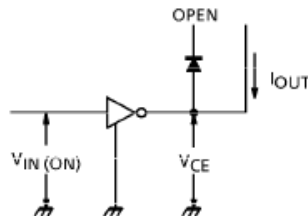

6. I_R

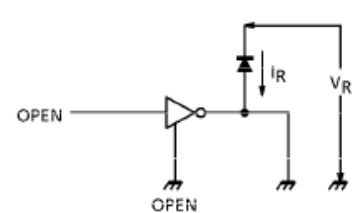

7. V_F

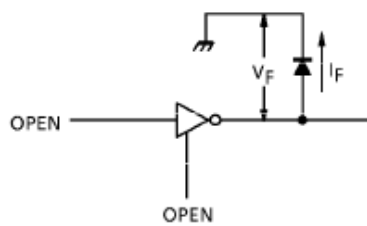

8. t_{ON} , t_{OFF}

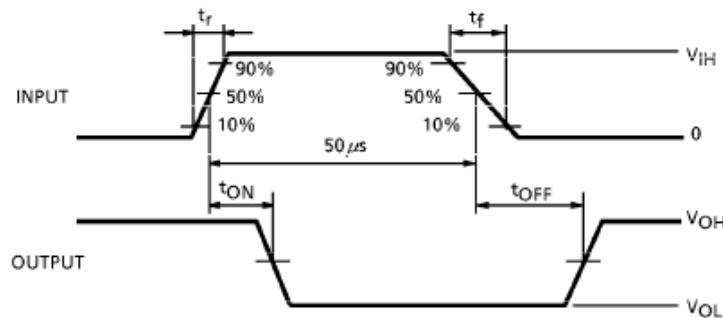
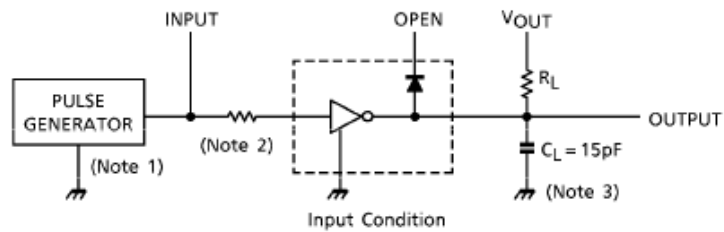

Note 1 : Pulse Width 50us, Duty Cycle 10%
 Output Impedance 50Ω, $t_r \leq 5ns$, $t_f \leq 10ns$
 Note 2 : See below.

Input Condition

| Type number | R1 | V_{IH} |
|-------------|----|----------|
| IK62083 | 0Ω | 3V |
| IK62084 | 0Ω | 8V |

Note 3 : C_L includes probe and jig capacitance

Precautions for Using

Utmost care is necessary in the design of output line, COMMON and GND line since IC may be destroyed due to short-circuit between outputs, air contaminaton fault, or fault by improper grounding.

IK62083N

IIN vs VIN

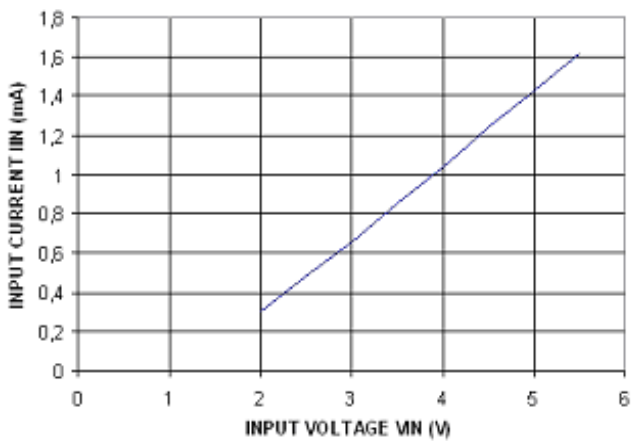

IK62084

IIN vs VIN

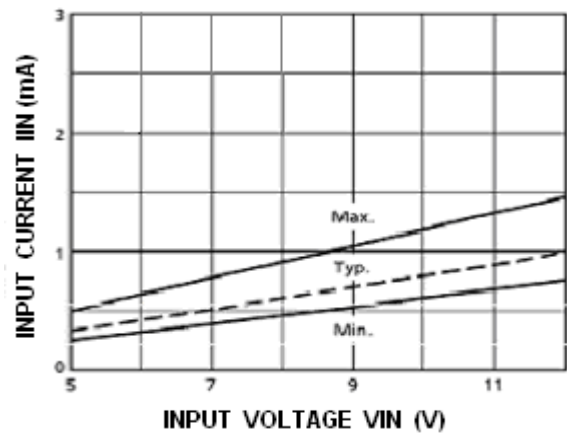

IOUT vs DUTY CYCLE

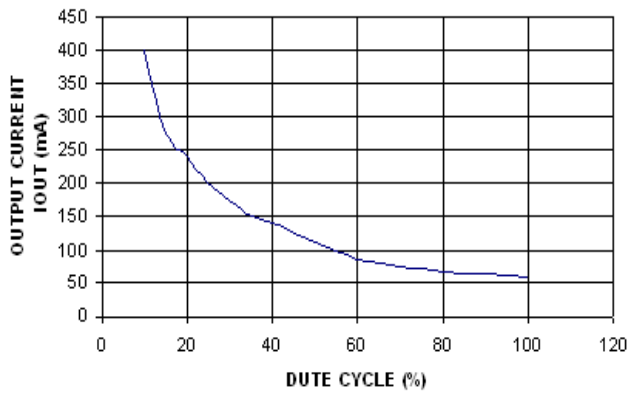

IOUT vs VCE (sat)

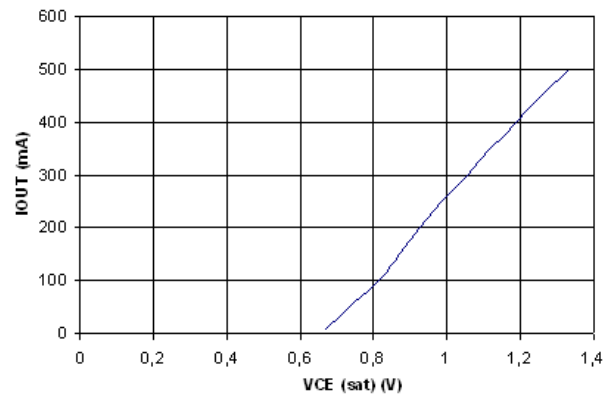

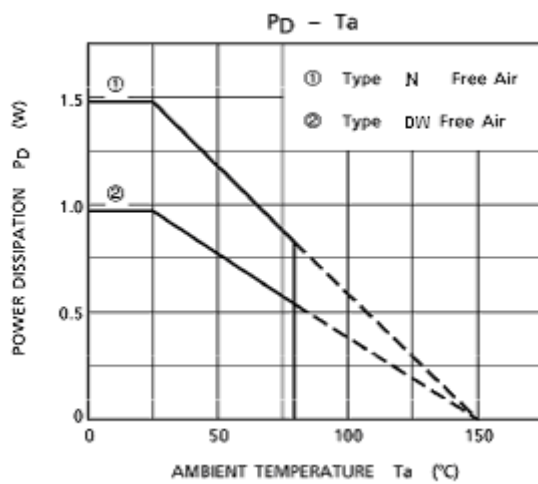
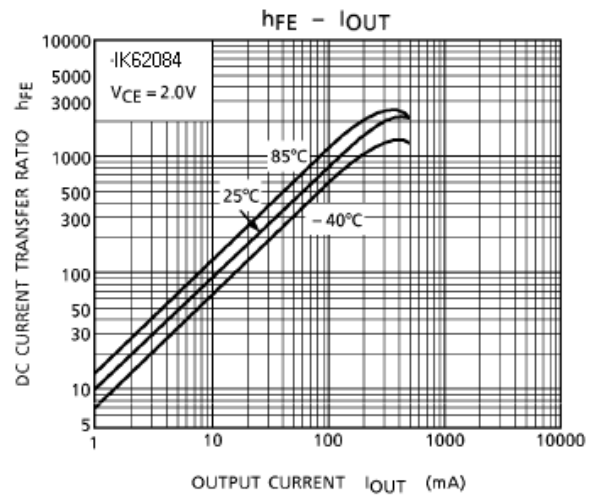
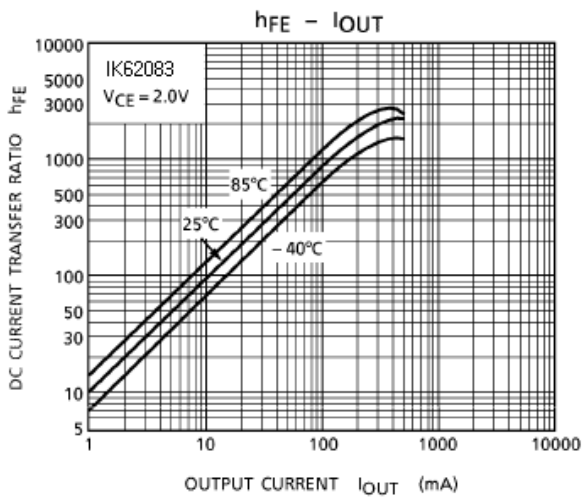

Package Dimensions

DIP-18

Unit: mm

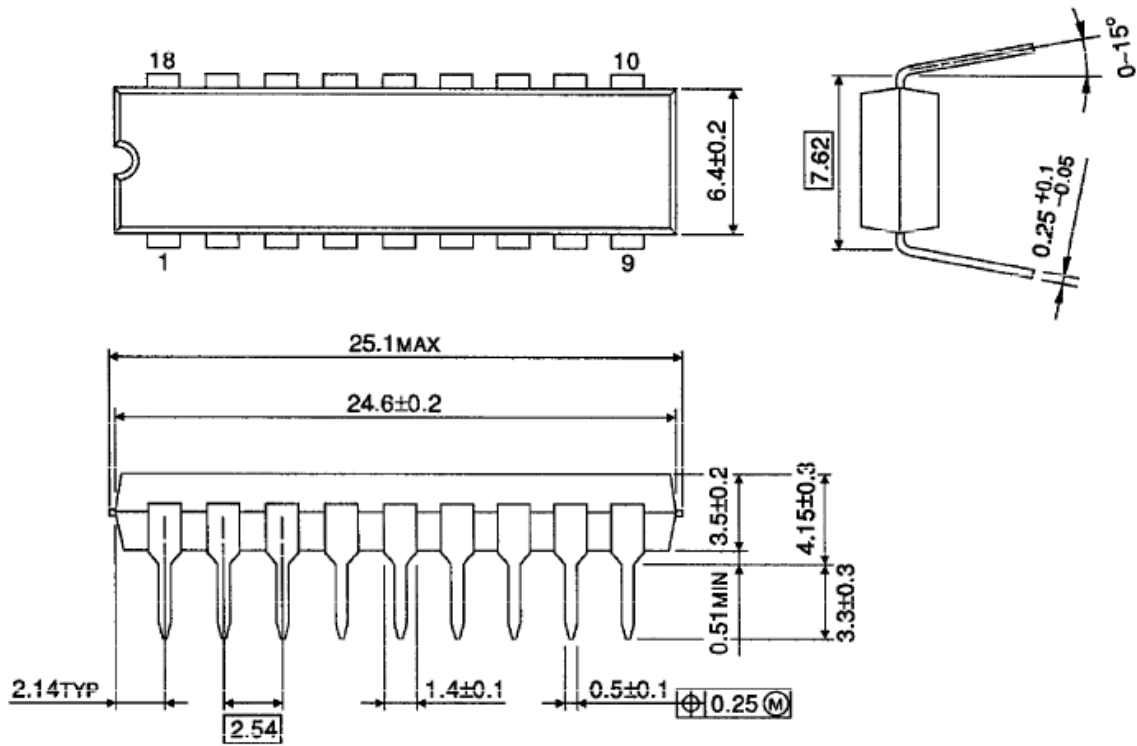

SOP-18

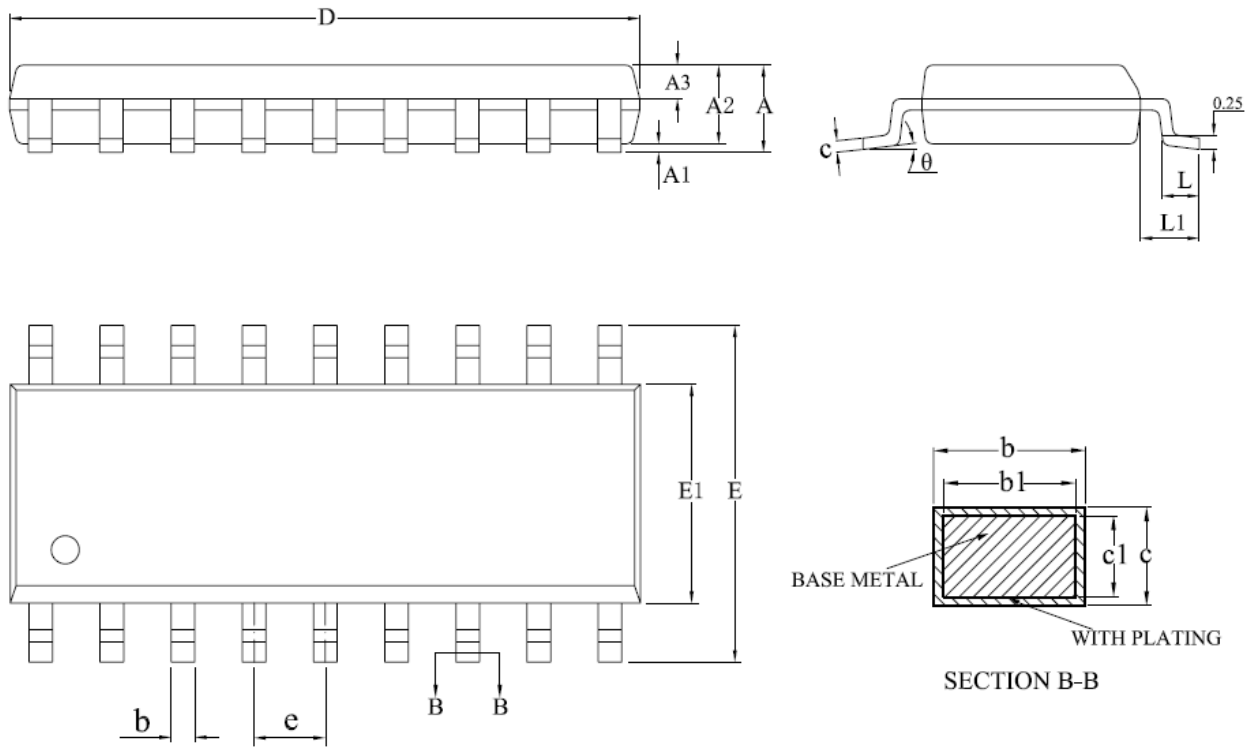

| SYMBOL | MILLIMETER | | |
|------------------|------------|-------|-------|
| | MIN | NOM | MAX |
| A | — | — | 2.70 |
| A1 | 0.10 | — | 0.28 |
| A2 | 2.25 | 2.30 | 2.35 |
| A3 | 0.97 | 1.02 | 1.07 |
| b | 0.35 | — | 0.44 |
| b1 | 0.34 | 0.37 | 0.39 |
| c | 0.26 | — | 0.31 |
| c1 | 0.24 | 0.25 | 0.26 |
| D | 11.25 | 11.45 | 11.65 |
| E | 10.10 | 10.30 | 10.50 |
| E1 | 7.30 | 7.50 | 7.70 |
| e | 1.27BSC | | |
| L | 0.70 | — | 1.00 |
| L1 | 1.40BSC | | |
| θ | 0 | — | 8° |
| L/P载体尺寸 (mil) | 140*160 | | |