

# INTERVAL- and WIPE/WASH WIPER CONTROL IC

**IK642B**

The IK642B is a bi-polar integrated circuit designed for the wiper application in the automotive market. It includes wipe, wash and internal mode.

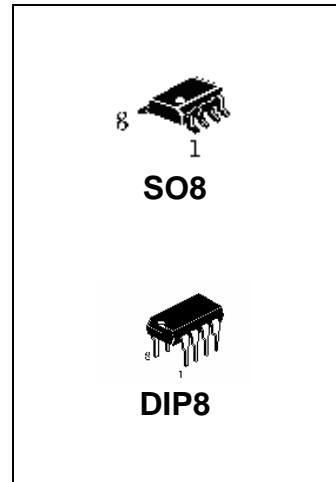

## FEATURES

- Interval Pause: 4 to 20 s
- After-wiping Time: 2 to 20 s
- Wiper Motor's Park Switch
- Wipe/Wash Mode Priority
- One External Capacitor Determines All Time Sequences
- Relay Driver with Z-diode
- Load-dump Protected
- Prewash Delay 300mS
- Interference Protection According to VDE 0839 or ISO/TR 7637/1

## ORDERING INFORMATION

Device	Operating Temperature Range	Package	Packing
IK642BN	$T_A = -40$ to $+85$ °C	DIP8	Tube
IK642BDT		SO8	Tape & Reel
IK642BD		SO8	Tube

## FUNCTIONAL DESCRIPTION

As a convenience feature of the windshield wiper, intermittent and wipe/wash operation functions are implemented in most of the automobiles. The IK642B is a cost-effective solution for an accurate timing function control. Wipe/wash mode has priority over interval mode. Interval pause and after-wiping time can be set to fixed values by using resistors in a broad time range. Added value can be provided with an individual, continuous adjustment of the interval pause by a potentiometer which may be built into the stalk. For proper operation, it is mandatory to feed the signal of the wiper motor's park switch into IK642B.

BLOCK DIAGRAM

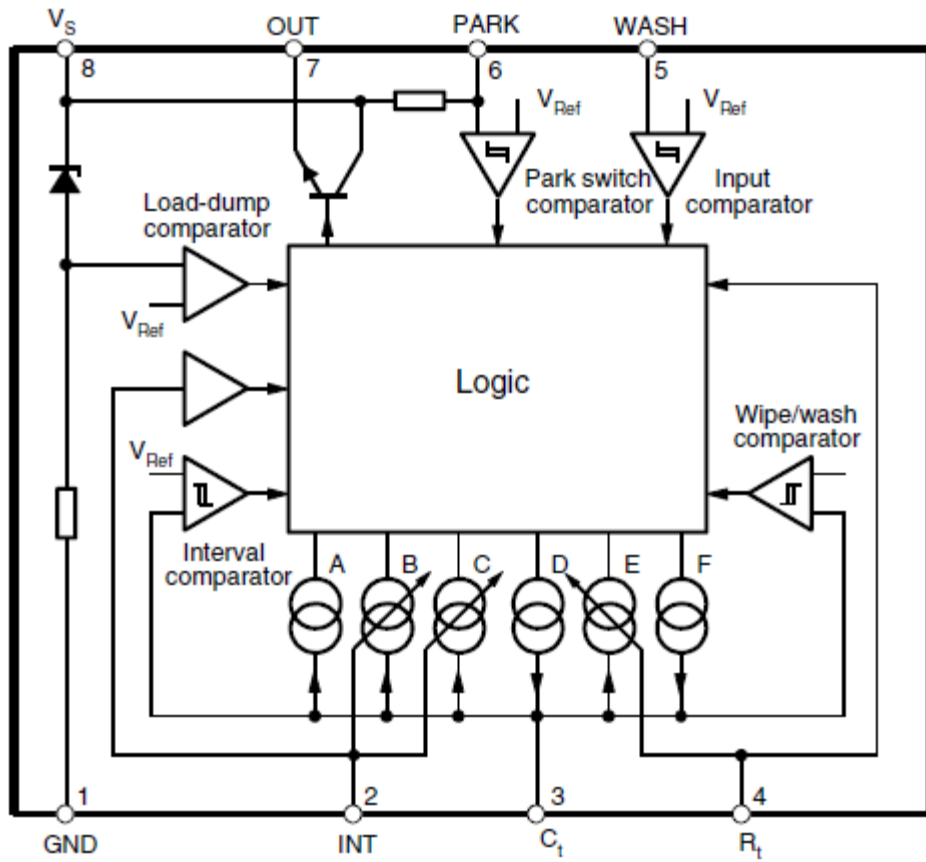

Figure 1

PIN CONFIGURATION

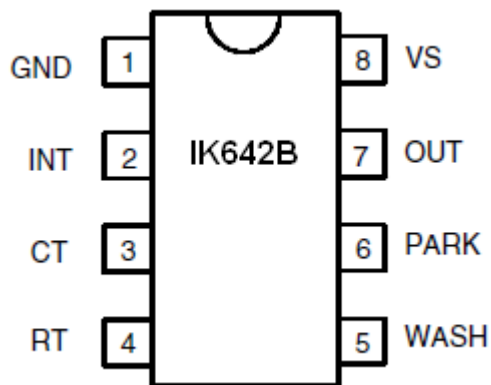

Figure 2

**PIN DESCRIPTION**

<b>Pin No.</b>	<b>Symbol</b>	<b>Description</b>
1	GND	Ground
2	INT	Interval switch
3	CT	Timing capacitor C2
4	RT	After-wiping time resistance
5	WASH	Wipe/wash switch
6	PARK	Park switch for wiper motor
7	OUT	Relay control output
8	VS	Supply voltage terminal 15

## CIRCUIT DESCRIPTION

### Interval Function, Pin 2

By closing the interval switch,  $S_2$ , to supply voltage,  $V_{Batt}$ , the relay is activated. The internal current source (pin 3) which holds the capacitor  $C_2$  in a charged state is switched-off. As soon as there is a positive potential at the park switch ( $S_1$ ), the current source F (see Figure 1 on page 1) charges the capacitor  $C_2$  very quickly. After the wiper operation is finished,  $S_1$  is again at ground potential, the relay is in the off position - interval pause begins -the capacitor  $C_2$  is discharged through the current source C, till the voltage at pin 3 is below the threshold of 2 V. Interval pause can be adjusted between 4 s to 20 s with the help of potentiometer  $R_3$ . Now the relay switches on and the next interval cycle begins. Opening of switch  $S_2$  causes the current source A to discharge  $C_2$  immediately and current sources C and F are switched-off.

### Wipe/Wash (WIWA) Operation, Pin 5

By closing the WIWA switch,  $S_3$ , to supply voltage,  $V_{Batt}$ , the water pump starts spraying water on the windshield. During this function, the current source A is switched-off which keeps the capacitor  $C_2$  in a discharged state. Now the capacitor is charged through the current sources D and F. If (after a time interval of approximately 100 ms) the voltage at the capacitor is greater than 6.5 V, the relay is turned on as long as the switch WIWA is closed.

The after-wiping time begins when the switch is open, the sources D and F are switched off and the source E is activated. Source E discharges the capacitor until the voltage is less than 2.2 V. The relay is off and the wiper-motor is supplied via the park switch until the park position is reached. The after-wiping time is determined by the current source E which can be regulated with the external resistor  $R_{Time}$ . When the after-wiping time has elapsed, the source A discharges the capacitor. The relay switch is independent of the park switch  $S_1$ .

### Interval and WIWA Functions

The interval function is interrupted immediately when the wipe/wash mode is activated. The current source A discharges the capacitor to a value of 2 V, afterwards, the normal wash function starts.

Interval wiping starts immediately when the after-wipe time is over. The switching delays are slightly shorter, because the capacitor is already charged to a value of 2 V.

The wipe/wash function is not interrupted when the interval switch  $S_2$  is activated. The interval function begins after the WIWA function has elapsed.

Figure 3. Application Circuit with Interval and Wipe/Wash Operation

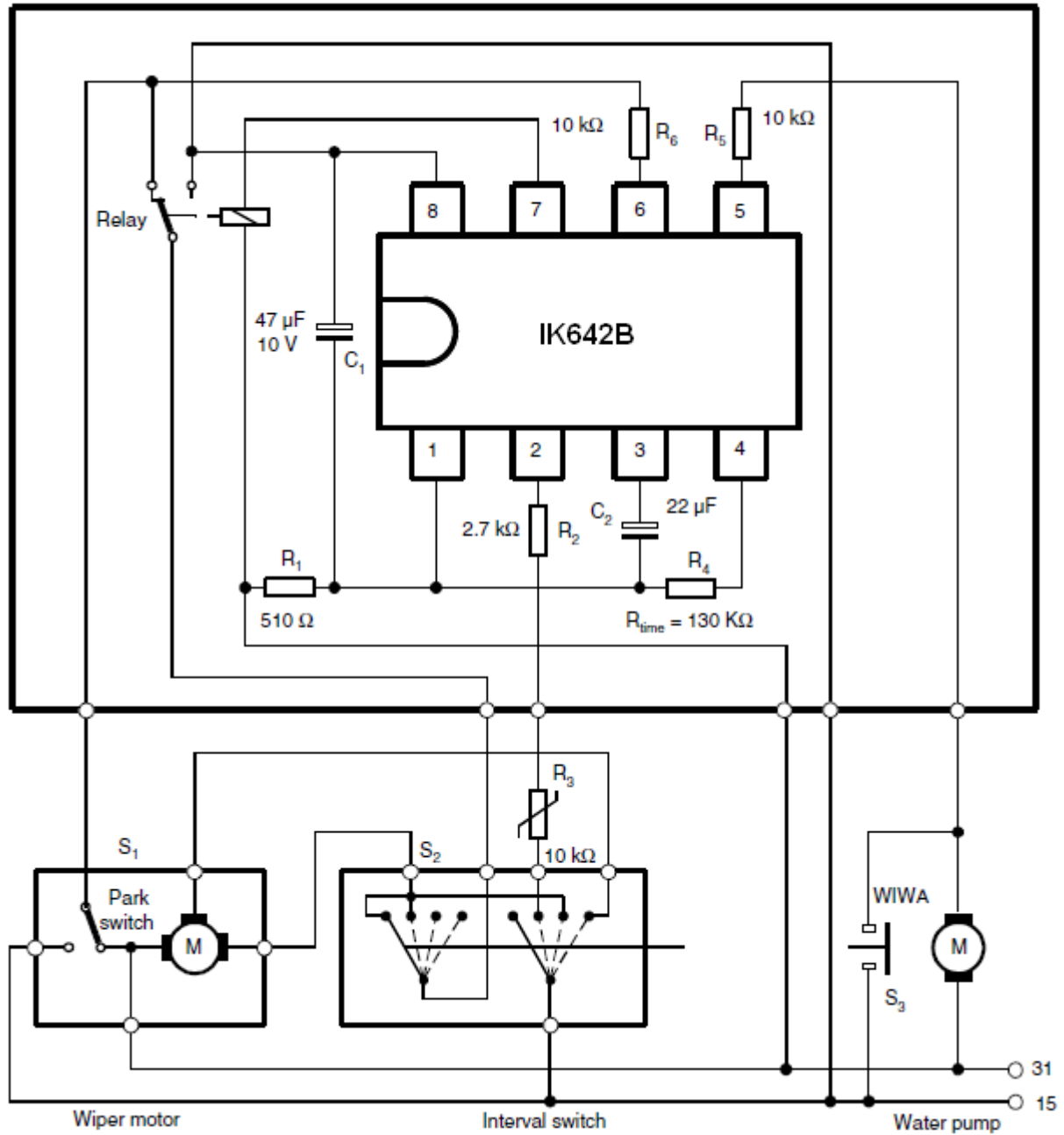

**ABSOLUTE MAXIMUM RATINGS**

Parameters	Pin	Symbol	Value	Unit
Supply voltage t = 60 s, terminal 15	8	V <sub>Batt</sub>	28	V
Supply current t = 2 ms	8	I <sub>8</sub>	1.5	A
t = 200 ms		I <sub>8</sub>	150	mA
Relay control output current (DC) t = 200 ms	7	I <sub>7</sub>	200	mA
		I <sub>7</sub>	1.2	A
<b>Pulse Current (Control Inputs) t = 200 ms</b>				
Park switch, S <sub>1</sub>	6	I <sub>6</sub>	50	mA
Wipe/Wash switch, S <sub>3</sub>	5	I <sub>5</sub>	50	
Interval switch, S <sub>2</sub>	2	I <sub>2</sub>	50	
Power dissipation T <sub>amb</sub> = 90°C		P <sub>tot</sub>	500	mW
Storage temperature range		T <sub>stg</sub>	-55 to +125	°C
Ambient temperature range		T <sub>amb</sub>	-40 to +85	°C

**THERMAL RESISTANCE**

Parameter		Symbol	Value	Unit
Junction ambient	DIP8	R <sub>thJA</sub>	120	K/W
	SO8	R <sub>thJA</sub>	160	K/W

Stresses beyond those listed under “Absolute Maximum Ratings” may cause permanent damage to the device. This is a stress rating only and functional operation of the device at these or any other conditions beyond those indicated in the operational sections of this specification are not implied. Exposure to absolute maximum rating conditions for extended periods may affect device reliability.

**ELECTRICAL CHARACTERISTICS**
 $V_{Batt} = 12V$ ,  $T_{amb} = 25^{\circ}C$ , reference point is pin 8 (see Figure 3 on page 4) unless otherwise specified.

Parameter	Test Conditions	Pin	Symbol	Min	Typ.	Max	Unit
Supply voltage		8	$V_{Batt}$	9		16.5	V
Supply current			$I_8$		10		mA
Z-diode limitation			$V_1$		7.6		V
<b>Overvoltage</b>							
Threshold current			$I_1$		-50		mA
Threshold voltage			$V_{Batt}$		35		V
<b>Relay Control Output</b> 7							
Saturation voltage	$I_7 = 100\text{ mA}$ $I_7 = 200\text{ mA}$		$V_7$			-1.0 -1.5	V
Leakage current			$I_7$		100		uA
<b>Park Switch</b> 6							
Internal pull-up resistance	$R_6 = 10\text{ k}\Omega$		$R_6$		50		k $\Omega$
Switching threshold voltage			$V_6$		-3.3		V
Protection diode	$I_6 = -10\text{ mA}$ $I_6 = 10\text{ mA}$		$V_6$ $V_6$		-0.8 7.6		V
<b>Input Ct</b> 3							
Internal resistance			$R_3$		100		$\Omega$
<b>Interval Input</b> $R_2 = 2.7\text{ to }30\text{ k}\Omega$ 2							
Protection diode	$I_2 = -10\text{ mA}$ $I_2 = 30\text{ mA}/10\text{ ms}$		$V_2$		-0.8 7.6		V
<b>WASH Input</b> $R_5 = 10\text{ k}\Omega$ 5							
Switching threshold/ Hysteresis			$V_5$		-1.4/ -5.4		V
Protection diode	$I_5 = -10\text{ mA}$ $I_5 = 10\text{ mA}$		V		-0.8 7.6		V
<b>Switching Characteristics</b> $R_4 = 47\text{ k}\Omega\text{ to }300\text{ k}\Omega$ , $I_4 = -150\text{ }\mu\text{A}$							
Interval time	$R_3 = 0\text{ k}\Omega$ $R_3 = 10\text{ k}\Omega$		$t_2$	3.6 10.8	4 12	4.4 13.2	s
Prewash delay			$t_{del}$		300		ms
After-wipe-time	$R_4 = 130\text{ k}\Omega$	5	$t_5$	4.75	5.25	5.75	s

DIAGRAMS

Figure 4. Interval Pause = f (T);  $C_t = 22 \mu\text{F}$

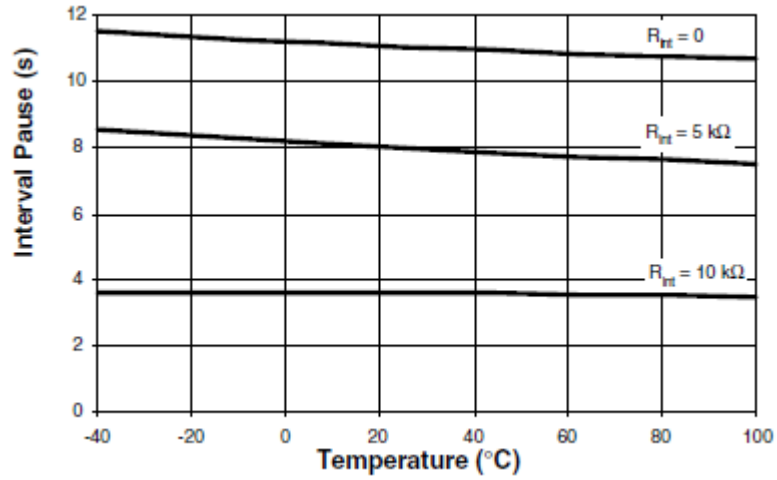

Figure 5. After-wiping Time = f (T);  $C_t = 22 \mu\text{F}$ ;  $V_{Batt} = 8 \text{ V}$

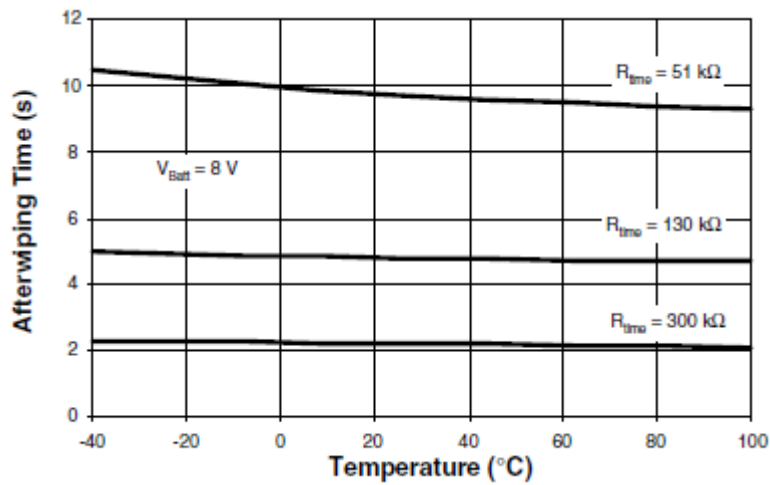

Figure 6. Interval Pause = f (RINT);  $C_t = 22 \mu\text{F}$

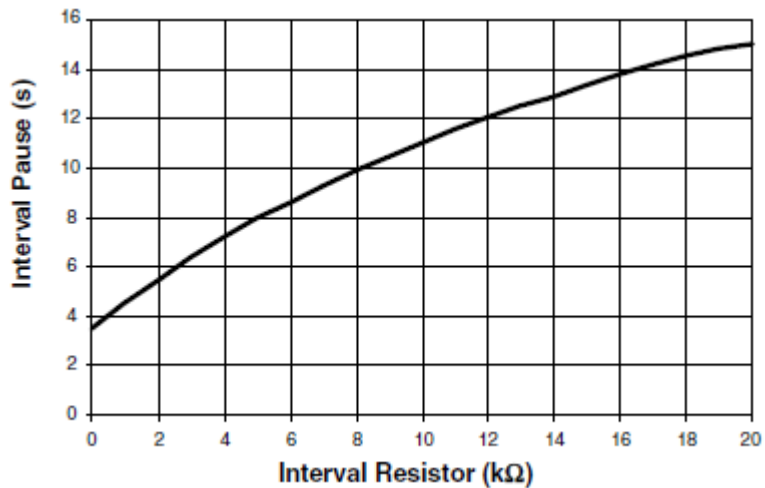
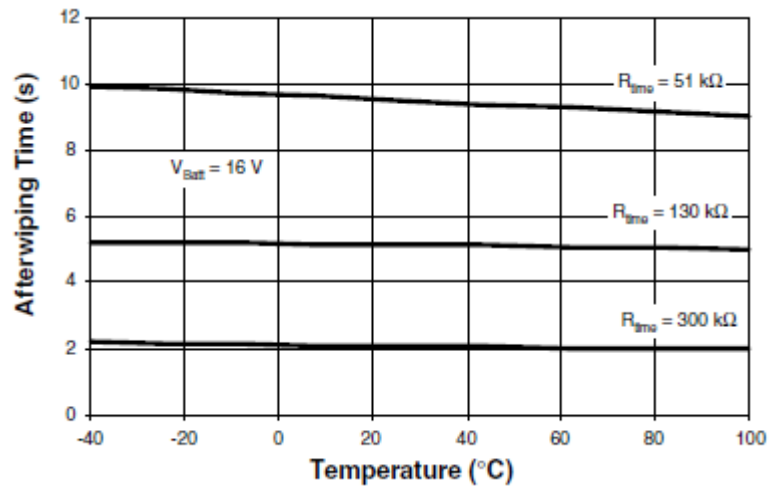

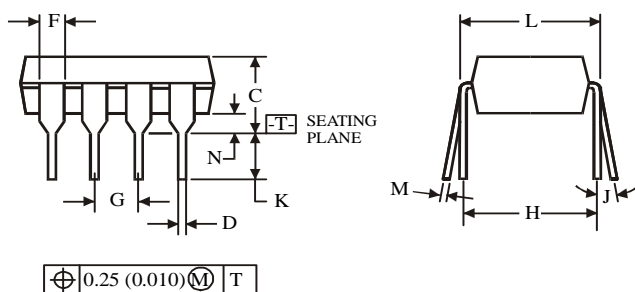
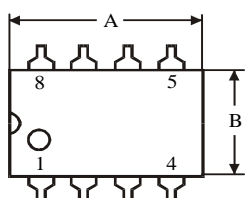
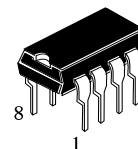

Figure 7. After-wiping Time = f (T);  $C_t = 22 \mu\text{F}$ ;  $V_{\text{Batt}} = 16 \text{ V}$



PACKAGE DIMENSION

N SUFFIX PLASTIC DIP  
(MS - 001BA)



Symbol	Dimension, mm	
	MIN	MAX
A	8.51	10.16
B	6.1	7.11
C		5.33
D	0.36	0.56
F	1.14	1.78
G	2.54	
H	7.62	
J	0°	10°
K	2.92	3.81
L	7.62	8.26
M	0.2	0.36
N	0.38	

NOTES:

- Dimensions “A”, “B” do not include mold flash or protrusions.  
Maximum mold flash or protrusions 0.25 mm (0.010) per side.

**D SUFFIX SOIC  
(MS - 012AA)**

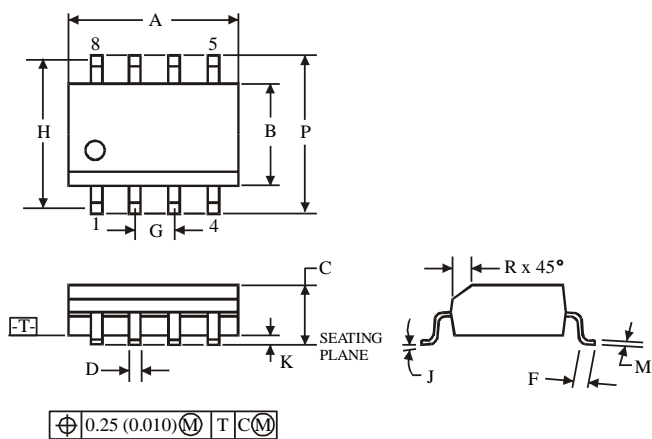
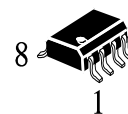

Symbol	Dimension, mm	
	MIN	MAX
A	4.8	5
B	3.8	4
C	1.35	1.75
D	0.33	0.51
F	0.4	1.27
G	1.27	
H	5.72	
J	0°	8°
K	0.1	0.25
M	0.19	0.25
P	5.8	6.2
R	0.25	0.5

**NOTES:**

1. Dimensions A and B do not include mold flash or protrusion.
2. Maximum mold flash or protrusion 0.15 mm (0.006) per side for A; for B - 0.25 mm (0.010) per side.