

IL205A/206A/207/208A SMALL OUTLINE SURFACE MOUNT PHOTOTRANSISTOR OPTOCOUPLER

FEATURES

- High Current Transfer Ratio, $I_F=10\text{ mA}$, $V_{CE}=5\text{ V}$
IL205A, 40–80%
IL206A, 63–125%
IL207A, 100–200%
IL208A, 160–320%
- High BV_{CEO} , 70 V
- Isolation Test Voltage, 2500 VAC_{RMS}
- Industry Standard SOIC-8 Surface Mountable Package
- Standard Lead Spacing, .05"
- Available in Tape and Reel Option—Suffix "T" (Conforms to EIA Standard RS481A)
- Compatible with Dual Wave, Vapor Phase and IR Reflow Soldering
- Underwriters Lab File #E52744 (Code Letter P)

DESCRIPTION

The IL205A/206A/207A/208A are optically coupled pairs with a Gallium Arsenide infrared LED and a silicon NPN phototransistor. Signal information, including a DC level, can be transmitted by the device while maintaining a high degree of electrical isolation between input and output. The IL205/6/7/8 come in a standard SOIC-8 small outline package for surface mounting which makes them ideally suited for high density applications with limited space. In addition to eliminating through-holes requirements, this package conforms to standards for surface mounted devices.

A specified minimum and maximum CTR allows a narrow tolerance in the electrical design of the adjacent circuits. The high BV_{CEO} of 70 volts gives a higher safety margin compared to the industry standard 30 volts.

Maximum Ratings

Emitter

Peak Reverse Voltage.....6.0 V
 Continuous Forward Current.....60 mA
 Power Dissipation at 25°C90 mW
 Derate Linearly from 25°C1.2 mW/°C

Detector

Collector-Emitter Breakdown Voltage70 V
 Emitter-Collector Breakdown Voltage7 V
 Collector-Base Breakdown Voltage70 V
 Power Dissipation150 mW
 Derate Linearly from 25°C2.0 mW/°C

Package

Total Package Dissipation at 25°C Ambient
 (LED + Detector)240 mW
 Derate Linearly from 25°C3.3 mW/°C
 Storage Temperature-55°C to +150°C
 Operating Temperature-55°C to +100°C
 Soldering Time at 260°C.....10 sec.

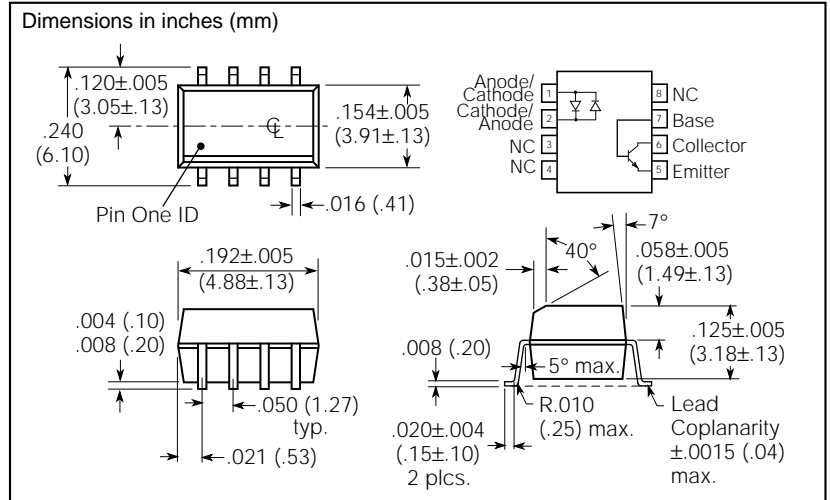

Characteristics ($T_A=25^\circ\text{C}$)

	Sym	Min.	Typ.	Max.	Unit	Condition
Emitter						
Forward Voltage	V_F		1.3	1.5	V	$I_F=\pm 10\text{ mA}$
Reverse Current	I_R		0.1	100	μA	$V_R=6.0\text{ V}$
Capacitance	C_O		25		pF	$V_R=0$
Detector						
Breakdown Voltage Collector-Emitter	BV_{CEO}	70			V	$I_C=100\text{ mA}$
Emitter-Collector	BV_{ECO}	7	10		V	$I_E=100\text{ }\mu\text{A}$
Leakage Current, Collector-Emitter	I_{CEO}		5	50	nA	$V_{CE}=10\text{ V}$
Package						
DC Current Transfer	CTR_{DC}				%	$I_F=\pm 10\text{ mA}$, $V_{CE}=5\text{ V}$
IL205A		40		80		
IL206A		63		125		
IL207A		100		200		
IL208A		100		320		
DC Current Transfer	CTR_{DC}				%	$I_F=\pm 1\text{ mA}$, $V_{CE}=5\text{ V}$
IL205A		13	25			
IL206A		22	40			
IL207A		34	60			
IL208A		56	95			
Saturation Voltage, Collector-Emitter	V_{CEsat}			0.4		$I_C=2.0\text{ mA}$, $I_F=10\text{ mA}$,
Isolation Test Voltage	V_{IO}	2500			VAC _{RMS}	
Equivalent DC Isolation Voltage		3535			VDC	
Capacitance, Input to Output	C_{IO}		0.5		pF	
Resistance, Input to Output	R_{IO}		100		G Ω	
Switching Time	t_{ON} , t_{OFF}		3.0		μs	$I_C=2.0\text{ mA}$, $R_E=100\text{ }\Omega$, $V_{CE}=10\text{ V}$

Figure 1. Forward voltage versus forward current

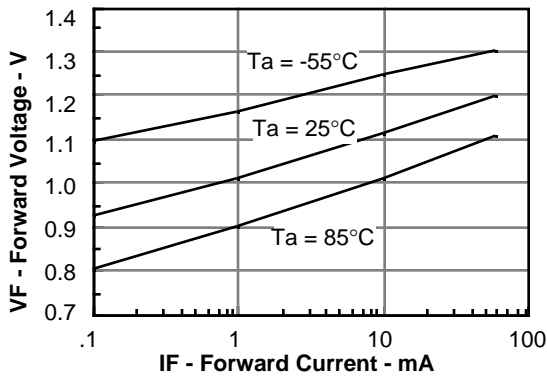

Figure 2. Normalized non-saturated and saturated CTR_{ce} versus LED current

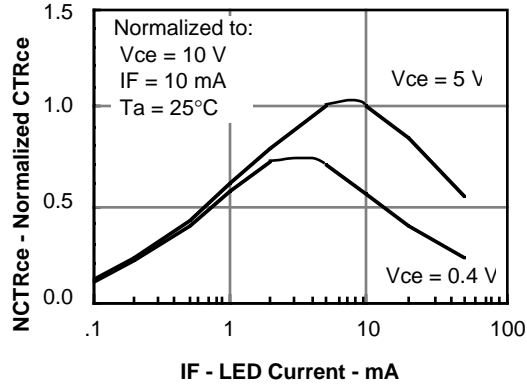

Figure 3. Collector-emitter current versus LED current

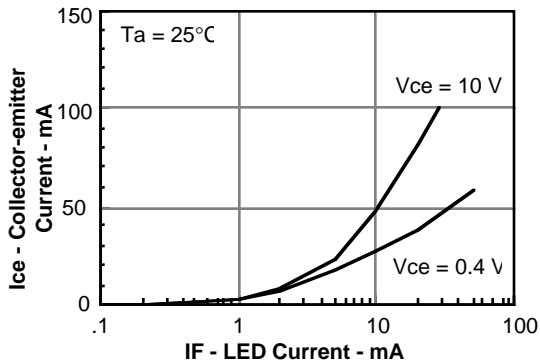

Figure 4. Normalized collector-base photocurrent versus LED current

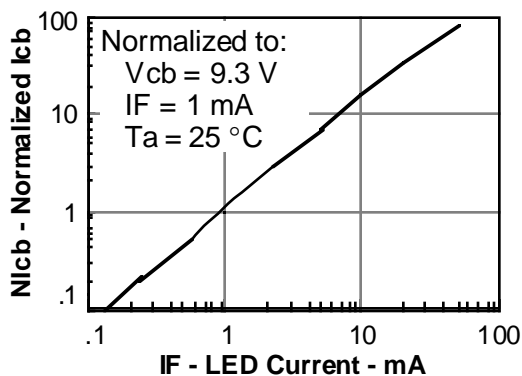

Figure 5. Normalized collector-base photocurrent versus LED current

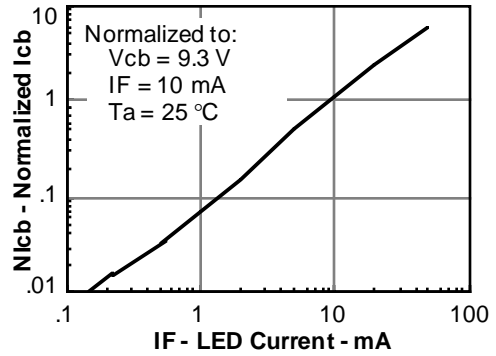

Figure 6. Collector-emitter photocurrent versus LED current

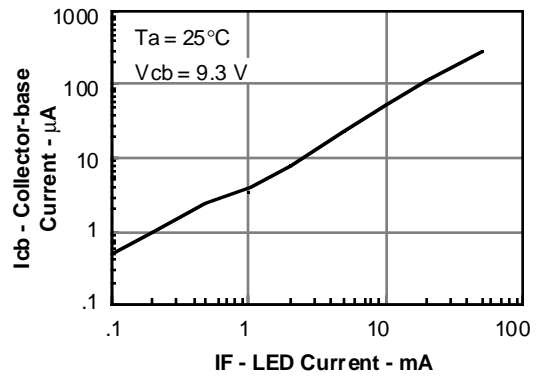

Figure 7. Collector-emitter photocurrent versus LED current

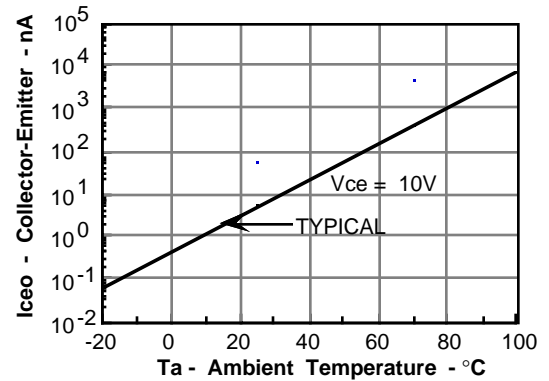

Figure 8. Base current versus I_{f} and HFE

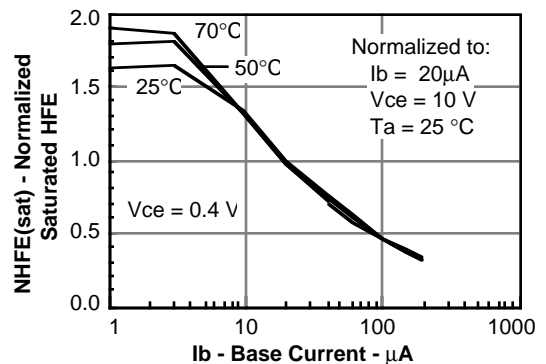

Figure 9. Typical switching characteristics versus base resistance (saturated operation)

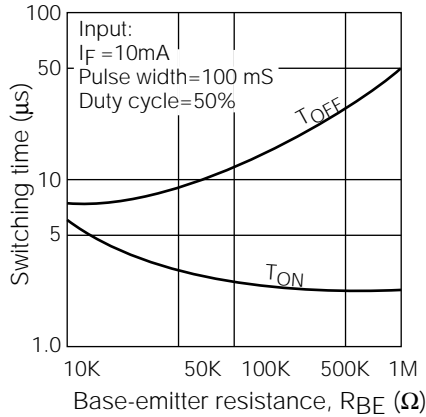

Figure 10. Typical switching times versus load resistance

