

IL221AT/IL222AT/IL223AT PHOTODARLINGTON SMALL OUTLINE SURFACE MOUNT OPTOCOUPLER

FEATURES

- High Current Transfer Ratio, $I_F=1$ mA, IL221AT, 100% Minimum
IL222AT, 200% Minimum
IL223AT, 500% Minimum
- Withstand Test Voltage, 2500 VAC_{RMS}
- Electrical Specifications Similar to Standard 6 Pin Coupler
- Industry Standard SOIC-8 Surface Mountable Package
- Standard Lead Spacing, .05"
- Available in Tape and Reel (suffix T) (Conforms to EIA Standard RS481A)
- Compatible with Dual Wave, Vapor Phase and IR Reflow Soldering
- Underwriters Lab File #E52744 (Code Letter P)

DESCRIPTION

The IL221AT/IL222AT/IL223AT is a high current transfer ratio (CTR) optocoupler with a Gallium Arsenide infrared LED emitter and a silicon NPN photodarlington transistor detector.

This device has a CTR tested at an 1 mA LED current. This low drive current permits easy interfacing from CMOS to LSTTL or TTL.

This optocoupler is constructed in a standard SOIC-8 foot print which makes it ideally suited for high density applications. In addition to eliminating through-holes requirements, this package conforms to standards for surface mounted devices.

Maximum Ratings

Emitter

Peak Reverse Voltage..... 6.0 V
Continuous Forward Current 60 mA
Power Dissipation at 25°C 90 mW
Derate Linearly from 25°C 1.2 mW/°C

Detector

Collector-Emitter Breakdown Voltage 30 V
Emitter-Collector Breakdown Voltage 5 V
Collector-Base Breakdown Voltage 70 V
Power Dissipation 150 mW
Derate Linearly from 25°C 2.0 mW/°C

Package

Total Package Dissipation at 25°C Ambient (LED + Detector) 240 mW
Derate Linearly from 25°C 3.3 mW/°C
Storage Temperature -55°C to +150°C
Operating Temperature -55°C to +100°C
Soldering Time at 260°C 10 sec.

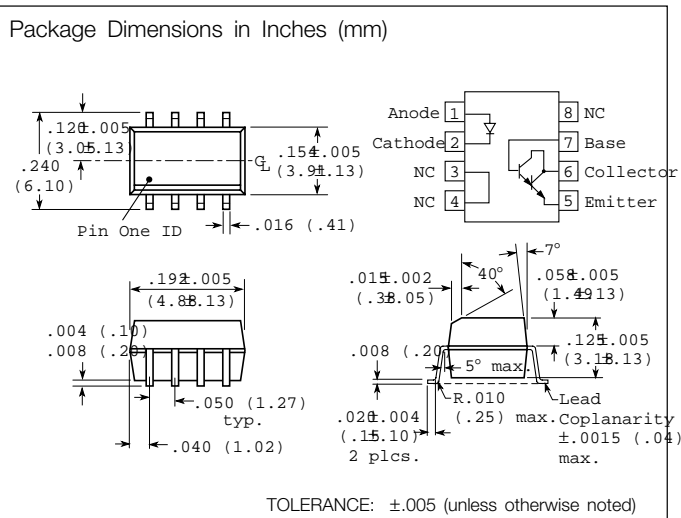

Characteristics ($T_A=25^\circ\text{C}$)

	Symbol	Min.	Typ.	Max.	Unit	Condition
Emitter						
Forward Voltage	V_F		1.0	1.5	V	$I_F=1$ mA
Reverse Current	I_R		0.1	100	μA	$V_R=6.0$ V
Capacitance	C_O		25		pF	$V_F=0$ V, $F=1$ MHz
Detector						
Breakdown Voltage						
Collector-Emitter	BV_{CEO}	30			V	$I_C=100$ μA
Emitter-Collector	BV_{ECO}	5			V	$I_E=100$ μA
Collector-Base Voltage	BV_{CBO}	70			V	$I_C=10$ μA
Collector-Emitter Capacitance	C_{CE}		3.4		pF	$V_{CE}=10$ V
Package						
DC Current Transfer Ratio						
IL221AT	CTR_{DC}	100				$I_F=1$ mA, $V_{CE}=5$ V
IL222AT		200				
IL223AT		500				
Collector-Emitter Saturation Voltage	V_{CEsat}			1	V	$I_{CE}=0.5$ mA, $I_F=1$ mA
Isolation Test						
Voltage	V_{IO}	2500			VAC _{RMS}	$t=1$ sec.
Capacitance,						
Input to Output	C_{IO}		0.5		pF	
Resistance,						
Input to Output	R_{IO}		100		G Ω	

Specifications subject to change.

Figure 1. Forward voltage versus forward current

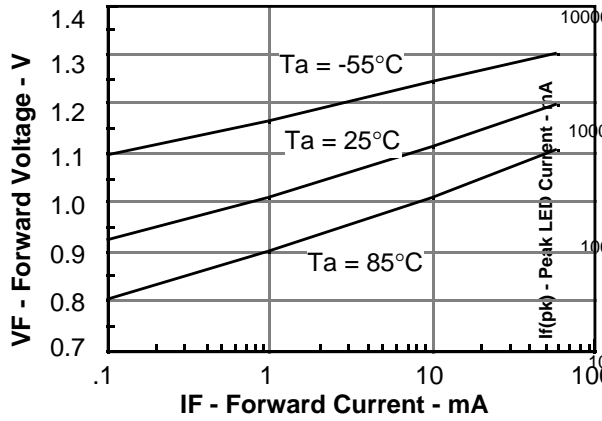

Figure 2. Peak LED current versus duty factor, Tau

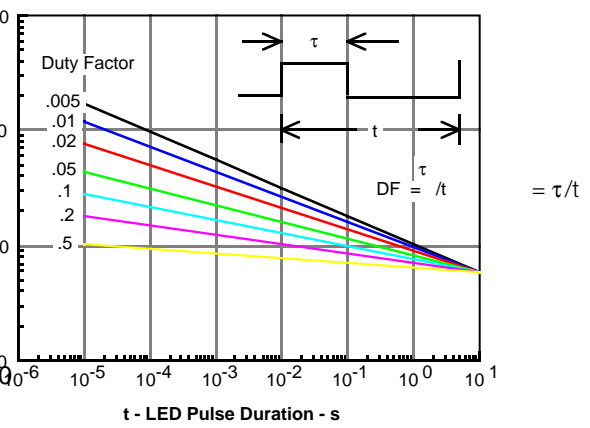

Figure 3. Normalized CTR_{CB} versus I_F

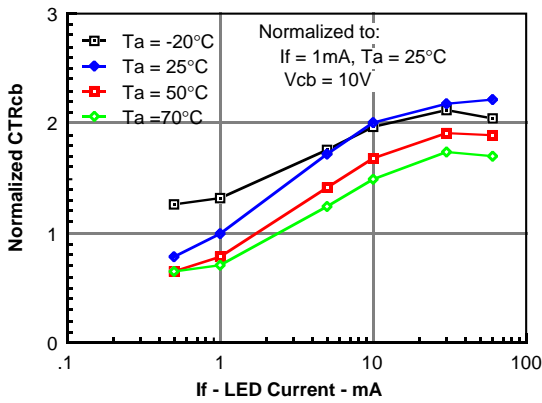

Figure 4. Normalized CTR_{CE} versus LED current

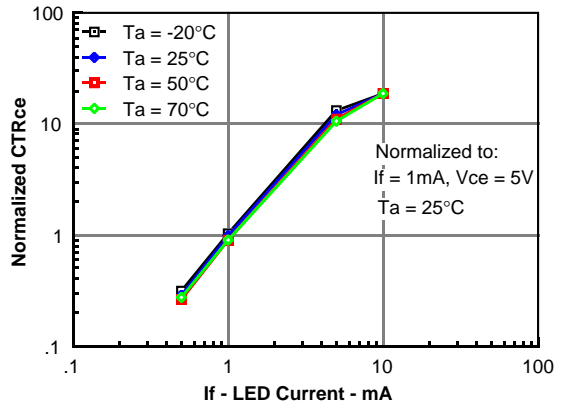

Figure 5. CTR_{CB} versus LED current

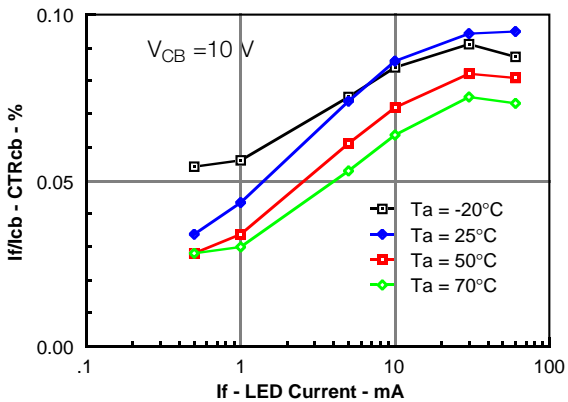

Figure 6. CTR versus LED current

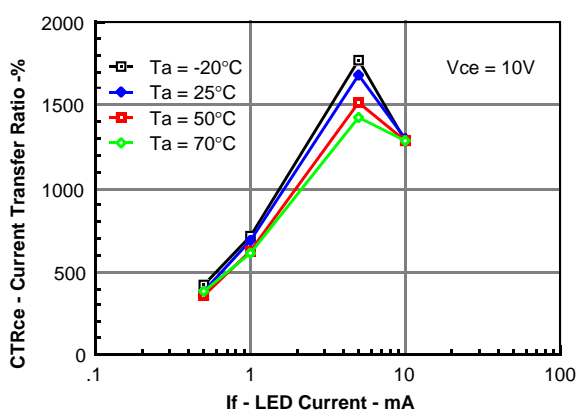

Figure 7. Collector current versus LED current

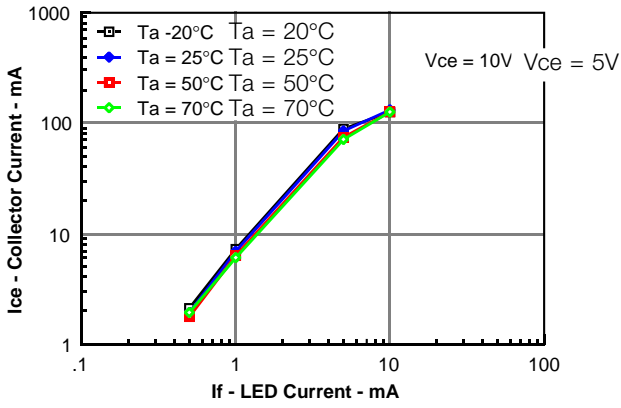

Figure 8. Photocurrent versus LED current

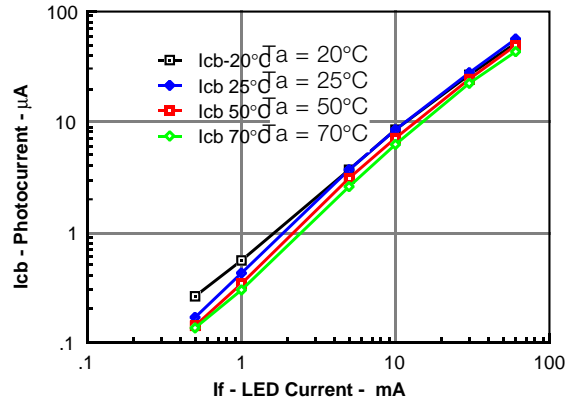

Figure 9. Normalized I_{CB} versus I_F

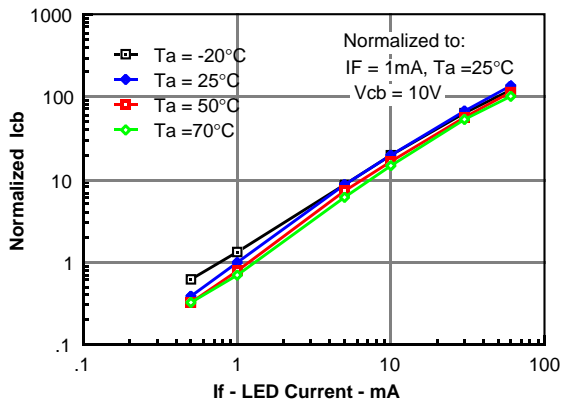

Figure 10. Switching Timing

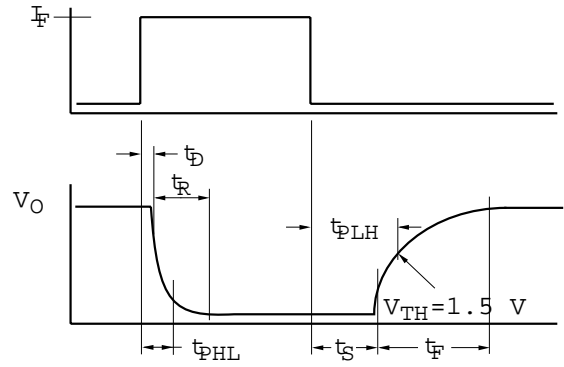

Figure 11. Switching schematic

