

Dual Low - Voltage Power Amplifier.

IL2822M

DESCRIPTION

The IL2822M is a monolithic integrated circuits of analog low - voltage power amplifier. It is intended for use as mono (bridge)/stereo audio power amplifier in portable cassette players and radios.

FEATURES

- Supply voltage down to 1,8 V
- Low crossover distortion
- Low quiescent current
- Bridge or stereo configuration

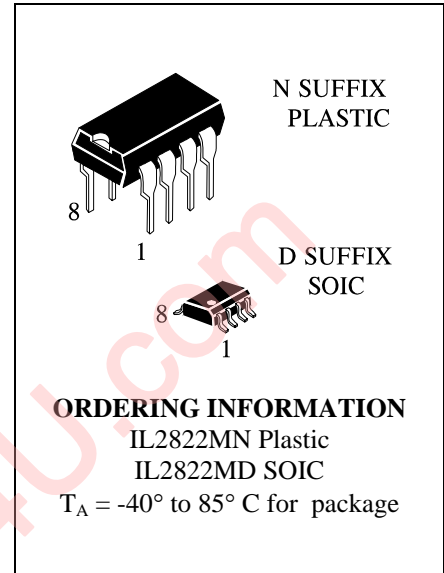

SCHEMATIC DIAGRAM

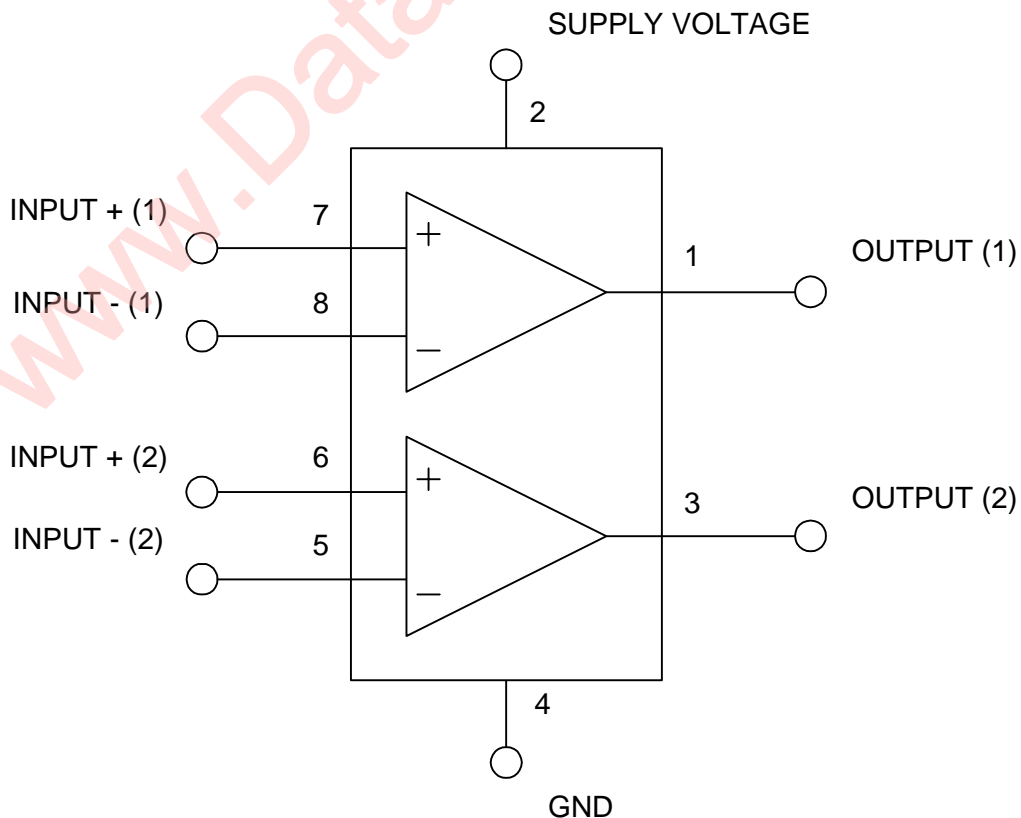

PIN CONFIGURATION

PIN №	I/O	NAME
1	OUTPUT	OUTPUT (1)
2		SUPPLY VOLTAGE
3	OUTPUT	OUTPUT (2)
4		GROUND
5	INPUT	INPUT - (2)
6	INPUT	INPUT + (2)
7	INPUT	INPUT - (1)
8	INPUT	INPUT + (1)

ABSOLUTE MAXIMUM RATINGS

Symbol	Parameter	Value	Unit
Vs	Supply Voltage	15	V
Io	Peak Output Current	1	A
Plot	Total Power Dissipation at Tamb = 50 °C at Tease = 50 °C	1 1.4	W W
Tstg, Tj	Storage and Junction Temperature	-40,+150	°C

ELECTRICAL CHARACTERISTICS ($V_s=6V$, $T_{amb}=25^{\circ}C$, unless otherwise specified)

Symbol	Parameter	Test Conditions	Min.	Typ.	Max.	Unit
STEREO						
V_s	Supply Voltage		1.8		15	V
V_o	Quiescent Output Voltage	$V_s=3V$		2.7 1.2		V V
I_d	Quiescent Drain Current			6	9	mA
I_b	Input Bias Current			100		nA
P_o	Output Power (each channel) ($f=1kHz, d=10\%$)	$R_L = 32\Omega V_s = 9V V_s=6V V_s = 4.5V$ $V_s=3V V_s=2V R_L=16\Omega V_s=6V R_L = 8\Omega$ $V_s = 9V V_s=6V R_L = 4\Omega V_s=6V V_s = 4.5V V_s=3V$	90 15 170 300 450	300 120 60 20 5 220 1000 380 650 320 110		mW
d	Distortion ($f = 1 kHz$)	$R_L = 32\Omega P_o = 40mW R_L=16\Omega$ $P_o=75mW R_L=8\Omega P_o=150mW$		0.2 0.2 0.2		% % %
G_v	Closed Loop Voltage Gain	$f=1kHz$	36	39	41	dB
A_{gv}	Channel Balance				± 1	dB
R_i	Input Resistance	$f=1kHz$	100			$k\Omega$
SN	Total Input Noise	$R_s=10k\Omega B= Curve A B = 22Hz to 22kHz$		2 2.5		$\mu V nV$
SVR	Supply Voltage Rejection	$f=100Hz, C1 = C2=100\mu F$	24	30		dB
C_s	Channel Separation	$f= 1kHz$		50		dB
BRIDGE						
V_s	Supply Voltage		1.8		15	V
I_d	Quiescent Drain Current	$R_L=-$		6	9	mA
V_{os}	Output Offset Voltage (between the outputs)	$R_L=S\Omega$			± 50	mV
I_b	Input Bias Current			100		nA
P_o	Output Power ($f= 1kHz, d= 10\%$)	$R_L = 32\Omega V_s = 9V V_s=6V V_s = 4.5V$ $V_s=3V V_s=2V R_L=16\Omega V_s=9V V_s=6V$ $V_s=3V R_L = 8\Omega V_s=6V V_s = 4.5V$ $V_s=3V R_L = 4\Omega V_s = 4.5V V_s=3V$ $V_s=2V$	320 50 900 200	1000 400 200 65 8 2000 800 120 1350 700 220 1000 350 80		mW
d	Distortion	$P_o = 0.5W, R_L = 8\Omega, f = 1 kHz$		0.2		%
G_v	Closed Loop Voltage Gain	$f=1kHz$		39		dB
R_i	Input Resistance	$f=1kHz$	100			$k\Omega$
ON	Total Input Noise	$R_s=10k\Omega B= Curve A B = 22Hz to 22kHz$		2.5 3		$\mu V uV$
SVR	Supply Voltage Rejection	$f= 100Hz$		40		dB
B	Power Bandwidth (-3dB)	$R_L = 8\Omega, P_o = 1W$		120		kHz

**N SUFFIX PLASTIC DIP
(MS - 001BA)**

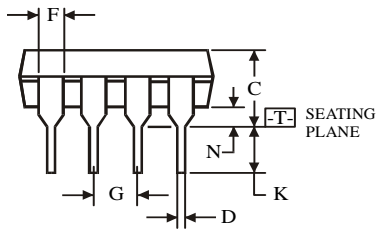
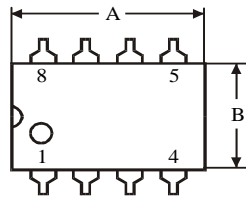
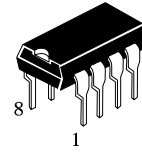

$\oplus 0.25 (0.010) \text{ (M) } T$

Symbol	Dimension, mm	
	MIN	MAX
A	8.51	10.16
B	6.1	7.11
C		5.33
D	0.36	0.56
F	1.14	1.78
G	2.54	
H	7.62	
J	0°	10°
K	2.92	3.81
L	7.62	8.26
M	0.2	0.36
N	0.38	

NOTES:

- Dimensions "A", "B" do not include mold flash or protrusions.
Maximum mold flash or protrusions 0.25 mm (0.010) per side.

**D SUFFIX SOIC
(MS - 012AA)**

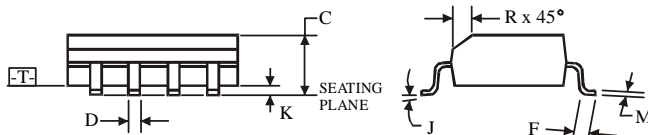
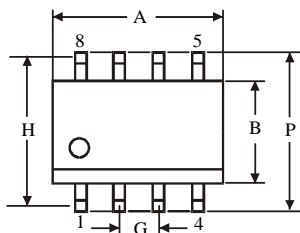
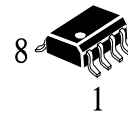

$\oplus 0.25 (0.010) \text{ (M) } T C \text{ (M)}$

Symbol	Dimension, mm	
	MIN	MAX
A	4.8	5
B	3.8	4
C	1.35	1.75
D	0.33	0.51
F	0.4	1.27
G	1.27	
H	5.72	
J	0°	8°
K	0.1	0.25
M	0.19	0.25
P	5.8	6.2
R	0.25	0.5

NOTES:

- Dimensions A and B do not include mold flash or protrusion.
- Maximum mold flash or protrusion 0.15 mm (0.006) per side
for A; for B - 0.25 mm (0.010) per side.