

FEATURES

- Internal RBE for High Stability
- High Current Transfer Ratio
at $I_F=2\text{ mA}$, $V_{CE}=5\text{ V}$
IL66B-1, 200% min.
IL66B-2, 750% min.
- Withstand Test Voltage, 5300 VAC_{RMS}
- No Base Connection
- High Isolation Resistance
- Standard Plastic DIP Package
- Underwriters Lab Approval #E52744
-  VDE 0884 Available with Option 1

DESCRIPTION

The IL66B is an optically coupled isolator employing a Gallium Arsenide infrared emitter and a silicon photodarlington detector. Switching can be accomplished while maintaining a high degree of isolation between driving and load circuits. They can be used to replace reed and mercury relays with advantages of long life, high speed switching and elimination of magnetic fields.

Maximum Ratings (at 25°C)

Emitter

Peak Reverse Voltage 6 V
 Continuous Forward Current 60 mA
 Power Dissipation at 25°C 100 mW
 Derate Linearly from 55°C 1.33 mW/°C

Detector

Collector-Emitter Breakdown Voltage 60 V
 Emitter-Collector Breakdown Voltage 5 V
 Power Dissipation at 25°C Ambient 200 mW
 Derate Linearly from 25°C 2.6 mW/°C

Package

Isolation Test Voltage (t=1 sec.) 5300 VAC_{RMS}
 Isolation Resistance
 $V_{IO}=500\text{ V}$, $T_A=25^\circ\text{C}$ $\geq 10^{12}\ \Omega$
 $V_{IO}=500\text{ V}$, $T_A=100^\circ\text{C}$ $\geq 10^{11}\ \Omega$
 Total Dissipation at 25°C 250 mW
 Derate Linearly from 25°C 3.3 mW/°C
 Creepage Path 7 min mm
 Clearance Path 7 min mm
 Storage Temperature -55°C to +150°C
 Operating Temperature -55°C to +100°C
 Lead Soldering Time at 260°C 10 sec.

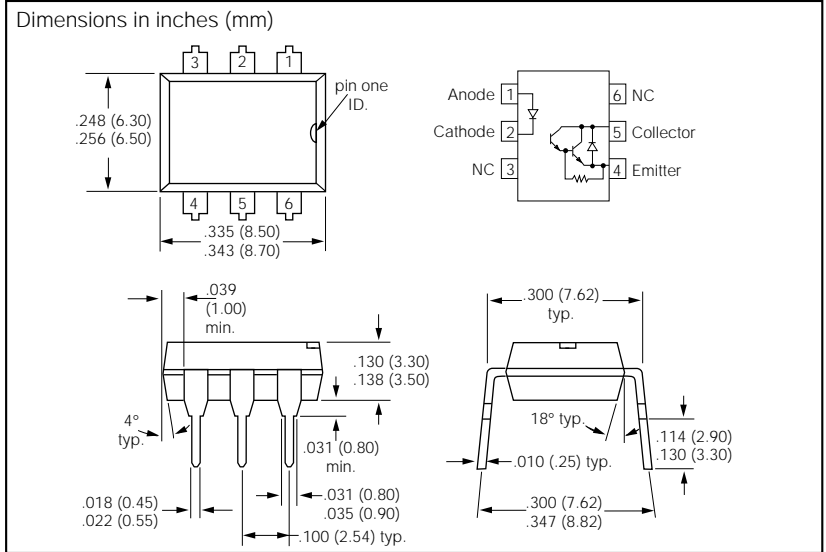

Electrical Characteristics ($T_A=25^\circ\text{C}$)

	Symbol	Min.	Typ.	Max.	Unit	Condition
Emitter						
Forward Voltage	V_F		1.25	1.5	V	$I_F=10\text{ mA}$
Reverse Current	I_R		0.01	100	μA	$V_R=3.0\text{ V}$
Capacitance	C_O		25		pF	$V_R=0\text{ V}$
Detector						
Breakdown Voltage Collector-Emitter	BV_{CEO}	60			V	$I_C=100\ \mu\text{A}$, $I_F=0$
Leakage Current Collector-Emitter	I_{CEO}		1.0	100	nA	$V_{CE}=50\text{ V}$, $I_F=0$
Package						
Current Transfer Ratio	CTR					$I_F=2\text{ mA}$, $V_{CE}=5\text{ V}$
IL66B-1		200			%	
IL66B-2		750	1000		%	
Saturation Voltage Collector-Emitter	V_{CEsat}			1.0	V	$I_C=10\text{ mA}$, $I_F=10\text{ mA}$
Turn-On, Turn-Off Time	t_{on}, t_{off}			200	μs	$V_{CC}=10\text{ V}$, $I_F=2\text{ mA}$, $R_L=100\ \Omega$

Figure 1. Forward voltage versus forward current

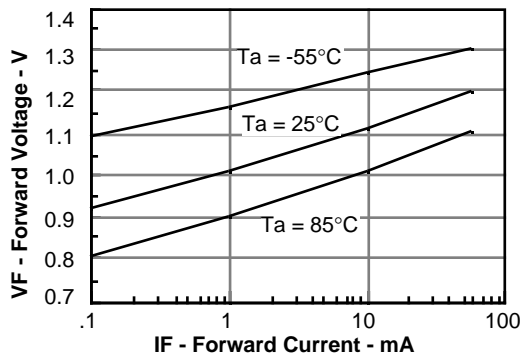

Figure 5. High/low propagation delay versus collector load resistance and LED current

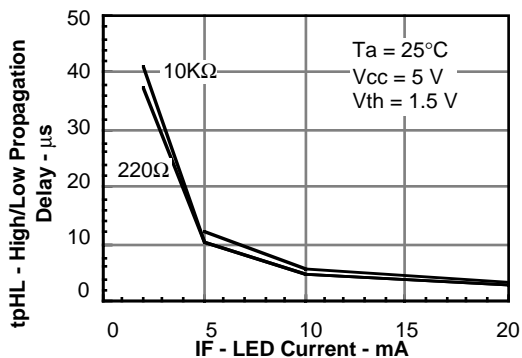

Figure 2. Normalized non-saturated and saturated CTRce versus LED current

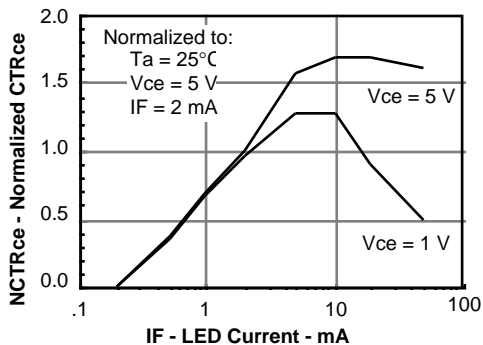

Figure 6. Low/high propagation delay versus collector load resistance and LED current

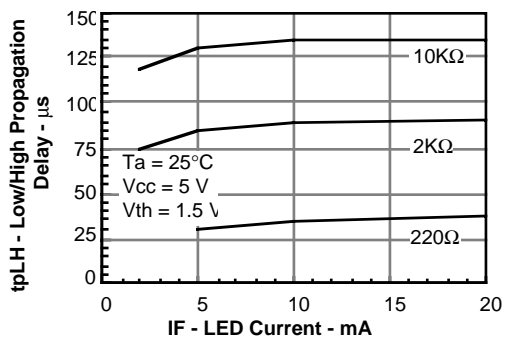

Figure 3. Normalized non-saturated and saturated CTRce versus LED current

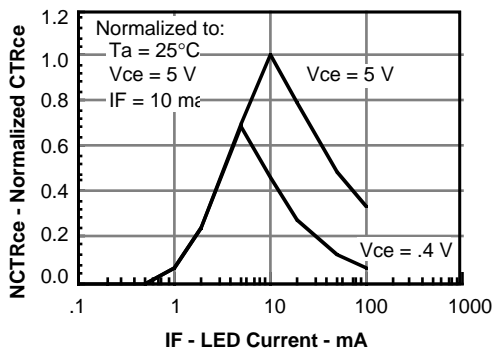

Figure 4. Non-saturated and saturated collector emitter current versus LED current

