

IL6840A

Telephone Tone Ringer with Bridge Diode

The IL6840A is a monolithic integrated circuit telephone tone ringer with bridge diode, when coupled with an appropriate transducer, it replaces the electro-mechanical bell. The device is designed for use with either a piezo transducer or an inexpensive transformer coupled speaker to produce a pleasing tone composed of a high frequency (f_R) alternating with a low frequency (f_L) resulting in a warble frequency. The supply voltage is obtained from the AC ring signal and the circuit is designed so that noise on the line or variation of the ringing signal can not affect correct operation of the device.

- On chip high voltage full wave diode bridge rectifier
- Low current consumption, in order to allow the parallel operation of the 4 devices
- Low external component count
- Tone and switching frequencies adjustable by external components
- High noise immunity due to built-in voltage-current hysteresis
- Activation voltage adjustable
- Internal zener diodes to protect against over voltages
- Ringer impedance adjustable with external components

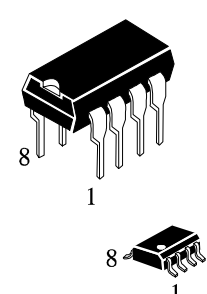

N SUFFIX
PLASTIC

D SUFFIX
SOIC

ORDERING INFORMATION
 IL6840AN Plastic DIP
 IL6840AD SOIC
 $T_A = -40^\circ$ to 70° C
 for package

PIN ASSIGNMENT

RING	1 ●	8	TIP
GND	2	7	RC
SRC	3	6	OUT
OFR	4	5	OUT

BLOCK DIAGRAM

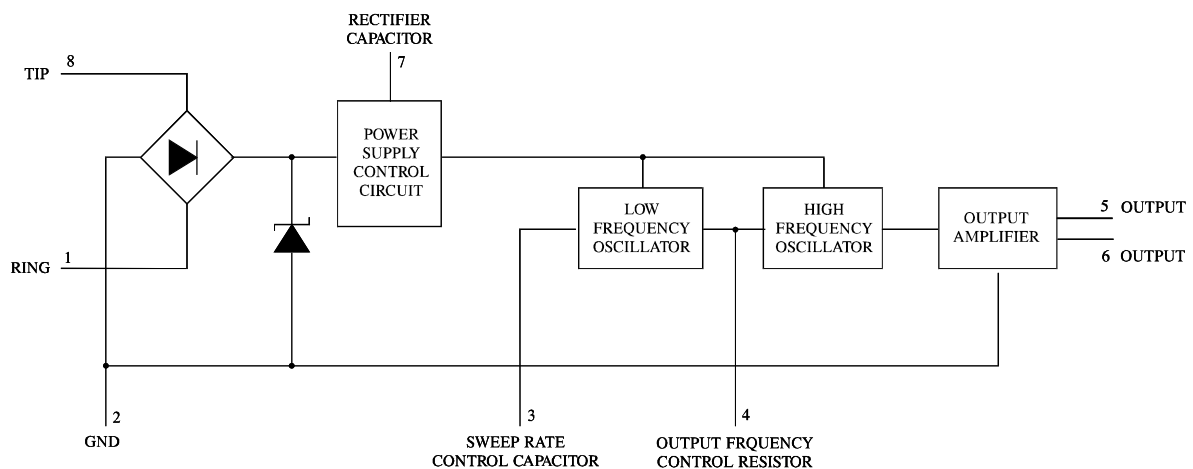

MAXIMUM RATINGS* ($T_A = 25^{\circ}\text{C}$)

Symbol	Parameter	Value	Unit
V_{TP}	Calling Voltage (f = 50 Hz) Continuous	120	V _{rms}
V_{TP}	Calling Voltage (f = 50 Hz) 5 Sec ON/10 Sec OFF	200	V _{rms}
I_{CC}	Supply Current	22	mA
Tstg	Storage and Junction Temperature	-60 to +125	°C

* Maximum Ratings are those values beyond which damage to the device may occur. Functional operation should be restricted to the Recommended Operating Conditions.

RECOMMENDED OPERATING CONDITIONS

Symbol	Parameter	Min	Max	Unit
V_{CC}	Supply Voltage		26	V
T_A	Operating Temperature	-40	+70	°C

This device contains protection circuitry to guard against damage due to high static voltages or electric fields. However, precautions must be taken to avoid applications of any voltage higher than maximum rated voltages to this high-impedance circuit. For proper operation, V_{IN} and V_{OUT} should be constrained to the range $GND \leq (V_{IN} \text{ or } V_{OUT}) \leq V_{CC}$.

Unused inputs must always be tied to an appropriate logic voltage level (e.g., either GND or V_{CC}). Unused outputs must be left open.

ELECTRICAL CHARACTERISTICS ($T_A = 25^{\circ}\text{C}$)

Symbol	Parameter	Test Conditions	Guaranteed Limits		Unit
			Min	Max	
I_{CC}	Current Consumption without Load	$V_S = 8.8 \text{ to } 26 \text{ V}$		1.8	mA
V_{ON}	Activation Voltage		12.2	13	V
V_{ONR}	Activation Voltage Range	$R_A = 1 \text{ K}\Omega$	8	10	V
V_{SUS}	Sustaining Voltage		8	8.8	V
R_D	Differential Resistance in Off Condition	$V_{TIP} = 8.0 \text{ V}$ $V_{RING} = 0 \text{ V}$	6.4	3500	$\text{K}\Omega$
V_{OUT}	Output Voltage Swing	$V_S = 26 \text{ V}$, $V_{SRC} = 8.0 \text{ V}$, $V_{OFR} = 8.0 \text{ V}$	21	25.5	V
I_{OUT}	Short Circuit Current	$V_S = 26 \text{ V}$	30	80	mA

AC CHARACTERISTICS

Symbol	Parameter	Test Conditions	Guaranteed Limits		Unit
			Min	Max	
f_{H1} f_{H2}	Output Frequencies	$V_{CC} = 26\text{ V}$, $R_1 = 14\text{ K}\Omega$			
	f_{H1} f_{H2}	$V_{SCR} = 0\text{ V}$ $V_{SCR} = 6\text{ V}$	1960 1420	2570 1840	Hz Hz
	f_H Range max	$V_{CC} = 26\text{ V}$, $R_1 = 1.7\text{ K}\Omega$, $V_{SCR} = 0\text{ V}$	14		KHz
	f_H Range min	$V_{CC} = 26\text{ V}$, $R_1 = 27\text{ K}\Omega$, $V_{SCR} = 6.0\text{ V}$		0.11	KHz
f_L	Sweep Frequency	$V_{CC} = 26\text{ V}$, $C_1 = 100\text{ nF}$	7.0	13.0	Hz

TEST AND APPLICATION CIRCUIT

Figure1 : Single output applied pin#5

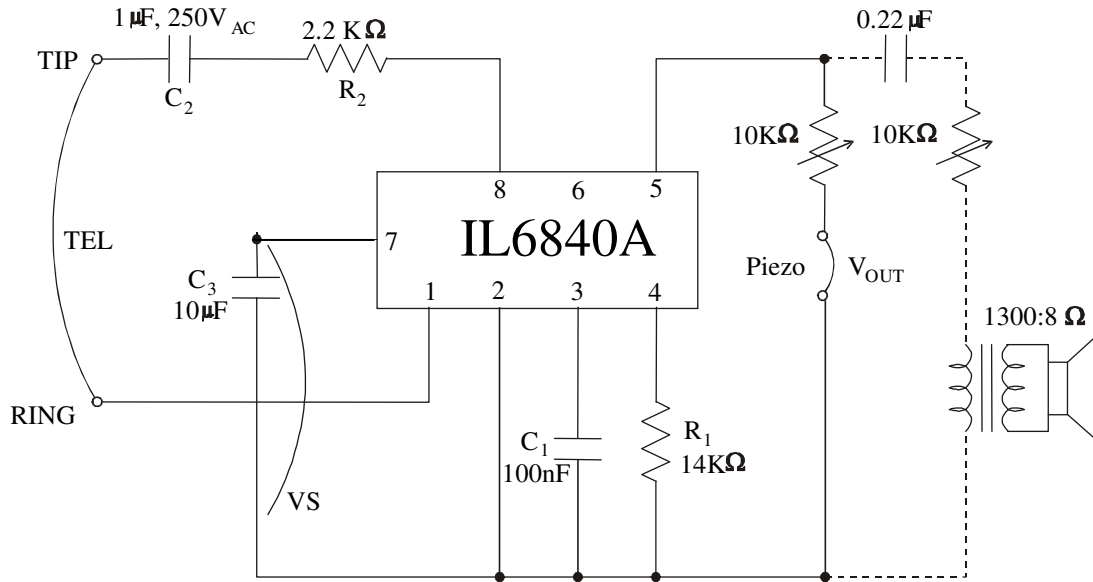

$$f_1 = 3.22 \cdot 10^4 / R_1 (\text{K}\Omega); \quad f_2 = 5/7 f_1; \quad f_{\text{sweep}} = 1000 / C_1(\text{nF})$$

Figure2 : Single output applied pin#6

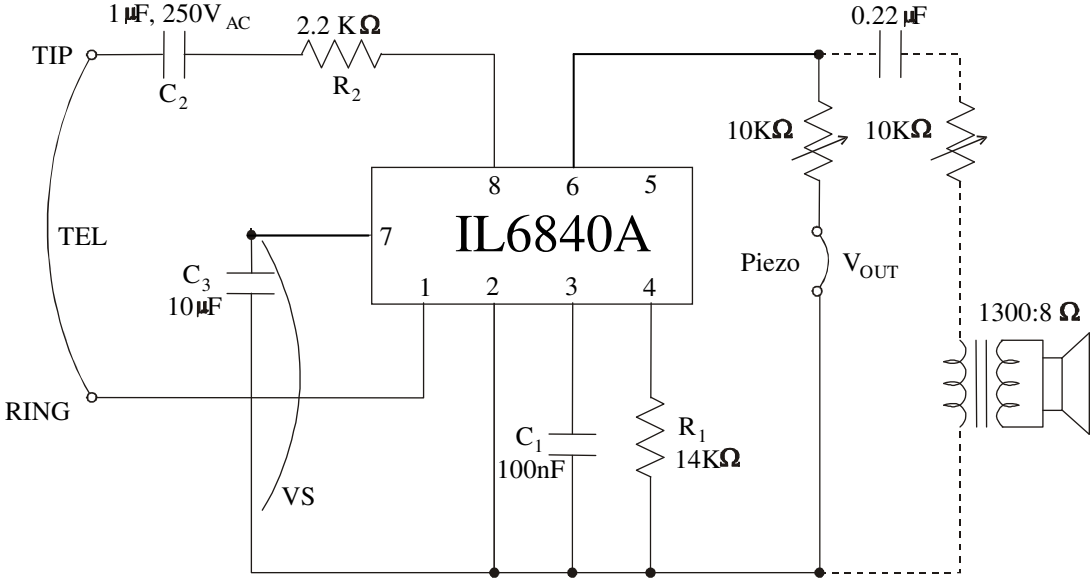

$$f_1 = 3.22 \cdot 10^4 / R_1 \text{ (K}\Omega\text{)}; f_2 = 5/7 f_1; f_{\text{sweep}} = 1000 / C_1 \text{ (nF)}$$

DESCRIPTION

The IL6840A tone ringer derives its power supply by rectifying the AC ringing signal. It uses this power to activate two tone generators. The two tone frequencies generated are switched by internal oscillator in a fast sequence and made audible across an output amplifier in the loudspeaker; both tone frequencies and the switching frequency can be externally adjusted.

The device can drive either directly a piezo ceramic converter (buzzer) or small loudspeaker. In case of using a loud-speaker, a transformer is needed.

An internal shunt voltage regulator provides DC voltage to the output stage, low frequency oscillator, and high frequency oscillator. To protect the IC from telephone line transients, a zener Diode is included.

**N SUFFIX PLASTIC DIP
(MS - 001BA)**

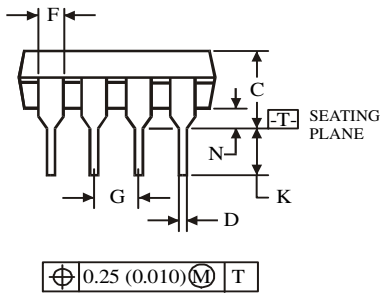
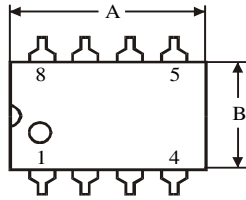
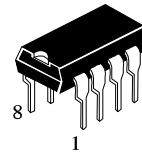

Symbol	Dimension, mm	
	MIN	MAX
A	8.51	10.16
B	6.10	7.11
C		5.33
D	0.36	0.56
F	1.14	1.78
G	2.54	
H	7.62	
J	0°	10°
K	2.92	3.81
L	7.62	8.26
M	0.20	0.36
N	0.38	

NOTES:

- Dimensions "A", "B" do not include mold flash or protrusions.
Maximum mold flash or protrusions 0.25 mm (0.010) per side.

**D SUFFIX SOIC
(MS - 012AA)**

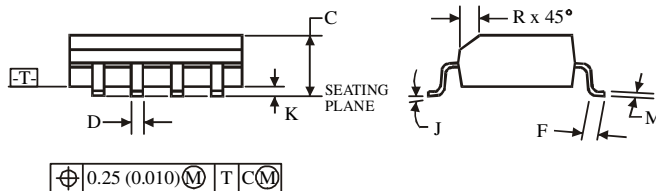
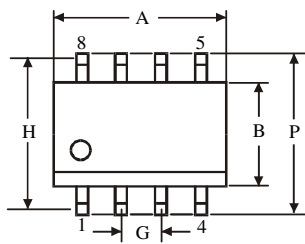
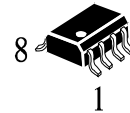

Symbol	Dimension, mm	
	MIN	MAX
A	4.80	5.00
B	3.80	4.00
C	1.35	1.75
D	0.33	0.51
F	0.40	1.27
G	1.27	
H	5.72	
J	0°	8°
K	0.10	0.25
M	0.19	0.25
P	5.80	6.20
R	0.25	0.50

NOTES:

- Dimensions A and B do not include mold flash or protrusion.
- Maximum mold flash or protrusion 0.15 mm (0.006) per side for A; for B - 0.25 mm (0.010) per side.