

IL7101N
EARTH LEAKAGE
CURRENT DETECTOR

Description

The IL7101N is designed for use in earth leakage circuit interrupters for operation directly off the AC Line in breakers. It contains pre regulator, main regulator, after regulator, differential amplifier, level comparator, latch circuit. The input in the differential amplifier is connect to the secondary node of zero current transformer. The level comparator generates high level when earth leakage current is greater than some level.

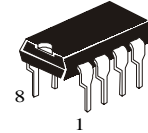

N SUFFIX
 PLASTIC

Pin Configuration
 (Top View)

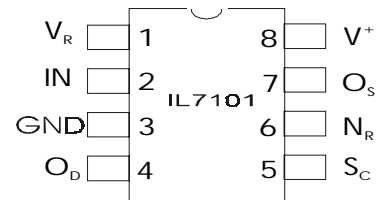

Feature

- Low Power Consumption ($P_D=5mW$) 100V/200V
- 100V/200V Common Built-in Voltage Regulator
- High Gain Differential Amplifier
- High Input Sensitivity
- Minimum External Parts
- Large Surge Margin
- Wide Operating Temperature Range ($T_A=-30$ to $85^\circ C$)
- High Noise Immunity

Absolute Maximum Ratings

- Supply Voltage 20V
- Supply Current 8mA
- Power Dissipation 200m W
- Operating Temperature - 30 to $85^\circ C$
- Storage Temperature - 55 to $125^\circ C$

Block Diagram

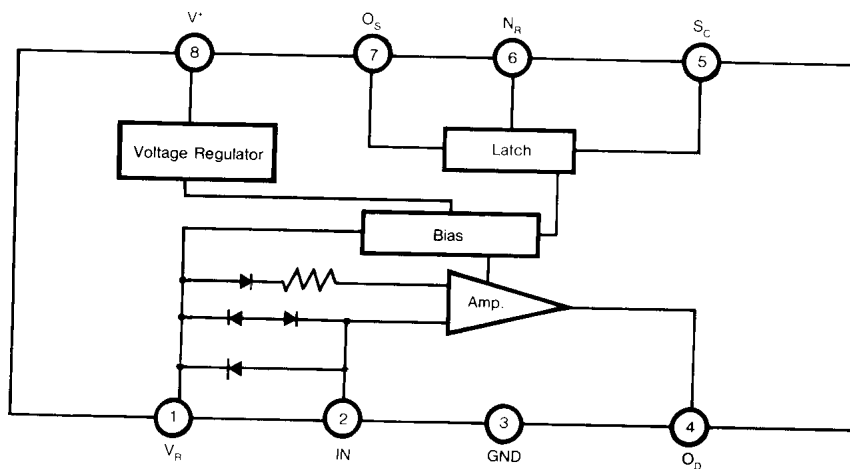

Recommended Operating Condition: T_A=-30°C to 80°C

PARAMETER	SYMBOL	MIN.	TYP.	MAX	UNIT
Supply Voltage	V ⁺	12			V
V _S -GND Capacitor	C _{vs}	1			μF
O _S -GND Capacitor	C _{os}			1	μF

Electrical Characteristics

PARAMETER	SYMBOL	CONDCTIONS	TEMP. (°C)	MIN.	TYP.	MAX.	UNIT
Supply Current 1	I _{S1}	V ⁺ =12V, V _R - V _I = 30 mV	-30	-	-	580	μA
			25	-	400	530	
			85	-	-	480	
* Trip Voltage	V _T	V ⁺ = 16V, V _R - V _I = X	-30 85	9	13.5	18	mV (rms)
Differential Amplifier Output Current 1	I _{TD1}	V ⁺ = 16 V, V _R - V _I = 30 mV V _{OD} = 1.2 V	25	-12	-	-30	μA
Differential Amplifier Output current 2	I _{TD2}	V ⁺ = 16 V, V _R - V _I = short V _{OD} = 0.8 V	25	17	-	37	μA
Output Current	I _o	V _{SC} = 1.4 V V _{OS} = 0.8 V	I _{S1} = 580μA	-30	-200	-	μA
			I _{S1} = 530μA	25	-100	-	
			I _{S1} = 480μA	85	-75	-	
S _C ON Voltage	V _{SC ON}	V ⁺ = 16 V	25	0.7	-	1.4	V
S _C Input Current	I _{SC ON}	V ⁺ = 12V	25	-	-	5	μA
Output "L" Current	I _{OSL}	V ⁺ = 12 V, V _{OSL} = 0.2 V	-30	200	-	-	μA
			85				
Input Clamp Voltage	V _{IC}	V ⁺ = 12 V, I _{IC} = 20 mA	-30 85	4.3	-	6.7	V
Differential Input Clamp Voltage	V _{IDC}	I _{IDC} = 100mA	-30	0.4	-	2	V
			85				
Max. Current Voltage	V _{SM}	I _{SM} = 7 mA	25	20	-	28	V
Supply Current 2	I _{S2}	V _{OS} = 0.5 V, V _R - V _I = X	-30 85	-	-	1200	μA
Latch Circuit Off Supply Votage	V+ OFF		25	0.5			V
Response Time	T _{ON}	V ⁺ = 16 V, V _R - V _I = 0.3 V	25	1	-	4	ms

* A: 9~12.5 B: 11.5~15.5 C: 14.5~18

Typical Performance Curves

VOLTAGE-SUPPLY VOLTAGE

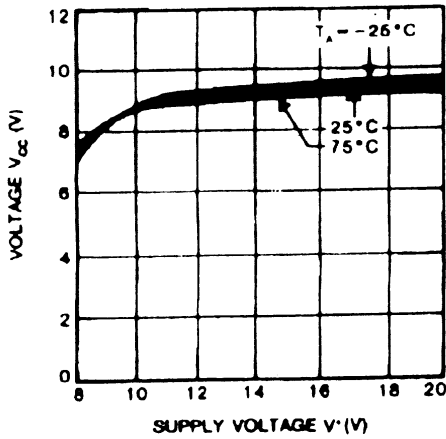

SUPPLY CURRENT-SUPPLY VOLTAGE

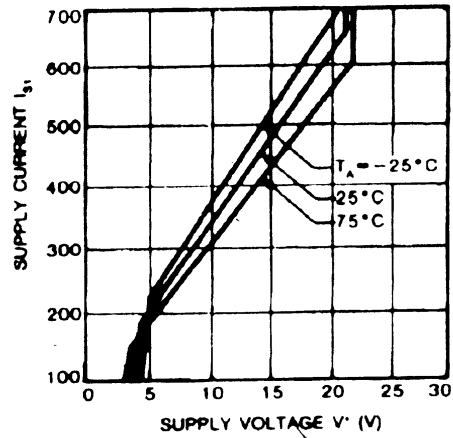

REFERENCE VOLTAGE-SUPPLY VOLTAGE

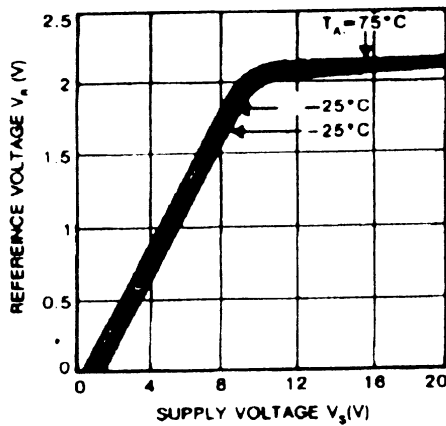

BIAS CURRENT-TEMPERATURE

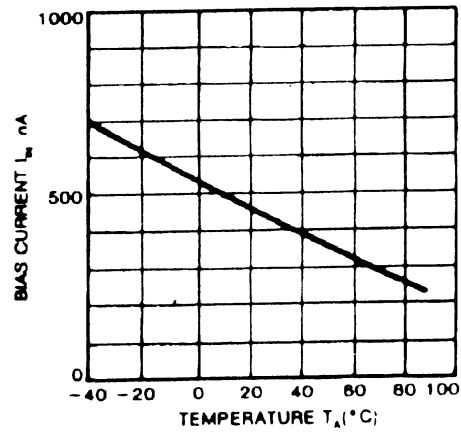

DIFFERENTIAL AMPLIFIER OUTPUT VOLTAGE-DIFFERENTIAL INPUT VOLTAGE

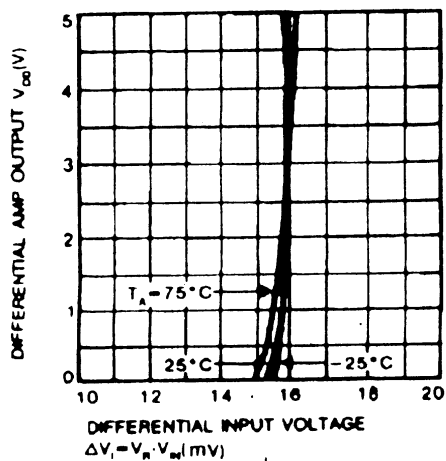

DIFFERENTIAL AMPLIFIER OUTPUT CURRENT-TEMP

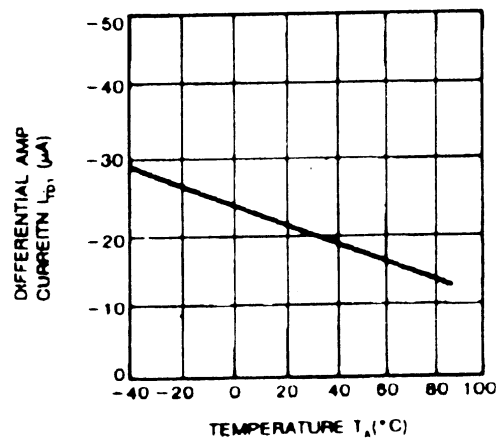

INTEGRAL

Typical Application

