

5 W MONO BTL AUDIO AMPLIFIER WITH DC VOLUME CONTROL

ILA7056B

The ILA7056B is a mono Bridge-Tied Load (BTL) output amplifier with DC volume control. It is designed for use in TV and monitors, but is also suitable for battery-fed portable recorders and radios. The device is contained in a 9-pin medium power package.

A Missing Current Limiter (MCL) is built in. The MCL circuit is activated when the difference in current between the output terminal of each amplifier exceeds 100 mA (300 mA typ.). This level of 100 mA allows for headphone applications (single-ended).

FEATURES

- DC volume control
- Few external components
- Mute mode
- Thermal protection
- Short-circuit proof
- No switch-on and switch-off clicks
- Good overall stability
- Low power consumption
- Low HF radiation
- ESD protected on all pins

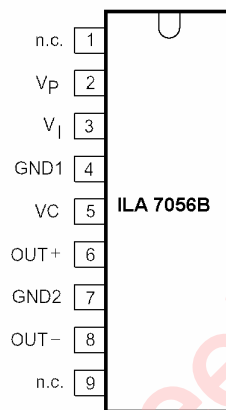

Figure 1. Pin connection

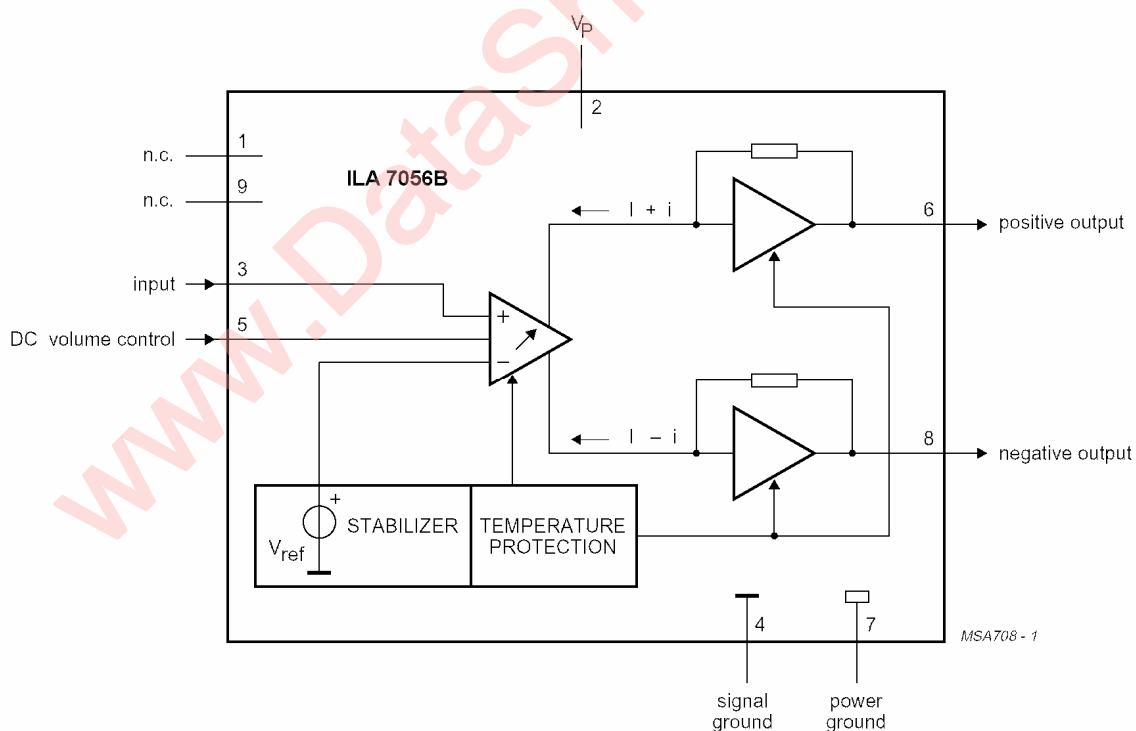
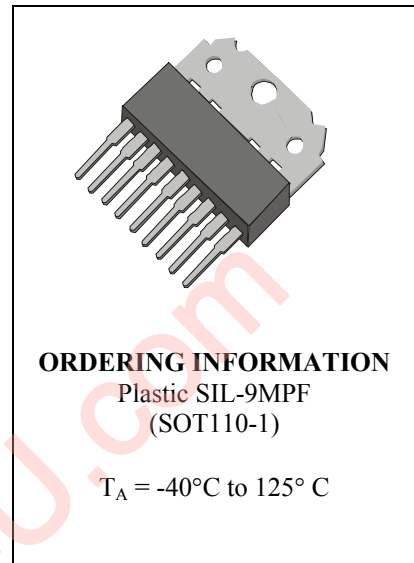

Figure 2. Simplified Block Diagram

MAXIMUM RATINGS

SYMBOL	PARAMETER	CONDITIONS	MIN	MAX	UNIT
V _P	supply voltage		-	18	V
V _{3,5}	input voltage pins 3 and 5		-	5	V
I _{ORM}	repetitive peak output current		-	1.25	A
I _{OSM}	non-repetitive peak output current		-	1.5	A
P _{tot}	total power dissipation	T _{case} < 60°C	-	9	W
T _{amb}	operating ambient temperature		-40	+85	°C
T _{stg}	storage temperature		-55	+150	°C
T _{vj}	virtual junction temperature		-	+150	°C
T _{sc}	short-circuit time		-	1	h

ELECTRICAL CHARACTERISTICS

V_P = 12 V; V_{DC} = 1.4 V; f = 1 kHz; R_L = 16 Ω; T_{amb} = 25 °C; unless otherwise specified (see Fig.13).

SYMBOL	PARAMETER	CONDITIONS	MIN	TYP	MAX	UNIT
Supply						
V _P	positive supply voltage		4.5	-	18	V
I _{q(tot)}	total quiescent current	note 1; R _L = ∞	-	9.2	13	mA
Maximum gain (V_S ≥ 1.4 V)						
P _O	output power	THD = 10%; R _L = 16 Ω	3	3.5	-	W
		THD = 10%; R _L = 8 Ω	-	5	-	W
THD	total harmonic distortion	P _O = 0.5 W	-	0.3	1	%
G _{v(max)}	maximum total voltage gain		39.5	40.5	41.5	dB
V _I	input signal handling (RMS value)	G _{v(max)} = 0 dB; THD < 1%	1.0	-	-	V
V _{no}	noise output voltage (RMS value)	note 2; f = 500 kHz	-	210	-	μV
B	bandwidth	at -1dB	-	0.02 to 300	-	kHz
SVRR	supply voltage ripple rejection	note 3	34	38	-	dB
ΔV _O	DC output offset voltage	V ₈ - V ₆	-	0	200	mV
Z _I	input impedance (pin 3)		15	20	25	kHz
Mute position						
V _O	output voltage in mute position	note 4; V _S = 0.4 V ± 30 mV V _I = 1.0 V	-	30	40	μV
DC volume control; note 5						
Φ	gain control		68	73.5	-	dB
I _S	control current	V _S = 0 V	20	25	30	μA

Notes

1. With a load connected to the outputs the quiescent current will increase, the maximum value of this increase being equal to the DC output offset voltage divided by R_L.
2. The noise output voltage (RMS value) at f = 500 kHz is measured with R_S = 0 Ω and B = 5 kHz.
3. The ripple rejection is measured with R_S = 0 Ω and f = 100 Hz to 10 kHz. The ripple voltage V_R of 200 mV (RMS value) is applied to the positive supply rail.
4. The noise output voltage (RMS value) is measured with R_S = 5 kΩ unweighted.
5. The DC volume control can be configured in several ways. Two possible circuits are shown in Figs 14 and 15. The circuits at the volume control pin will influence the switch-on and switch-off behaviour and the maximum voltage gain.

FUNCTIONAL DESCRIPTION

The ILA7056B is a mono BTL output amplifier with DC volume control, designed for use in TV and monitor but is also suitable for battery-fed portable recorders and radios.

In conventional DC volume circuits the control or input stage is AC coupled to the output stage via external capacitors to keep the offset voltage low. In the ILA7056B the DC volume control stage is integrated into the input stage so that no coupling capacitors are required. With this configuration, a low offset voltage is still maintained and the minimum supply voltage remains low.

The BTL principle offers the following advantages:

- Lower peak value of the supply current
- The frequency of the ripple on the supply voltage is twice the signal frequency.

Consequently, a reduced power supply with smaller capacitors can be used which results in cost reductions. For portable applications there is a trend to decrease the supply voltage, resulting in a reduction of output power at conventional output stages. Using the BTL principle increases the output power.

The maximum gain of the amplifier is fixed at 40.5 dB. The DC volume control stage has a logarithmic control characteristic. Therefore, the total gain can be controlled from 40.5 dB to -33 dB. If the DC volume control voltage falls below 0.4 V, the device will switch to the mute mode.

The amplifier is short-circuit proof to ground, V_p and across the load. Also a thermal protection circuit is implemented. If the crystal temperature rises above +150°C the gain will be reduced, thereby reducing the output power. Special attention is given to switch-on and switch-off clicks, low HF radiation and a good overall stability.

Power dissipation

Assume $V_p = 12\text{ V}$; $R_L = 16\ \Omega$.

The maximum sine wave dissipation is = 1.8 W.

The $R_{th\ vj-a}$ of the package is 55 K/W.

Therefore $T_{amb(max)} = 150 + 55 \times 1.8 = 51^\circ\text{C}$.

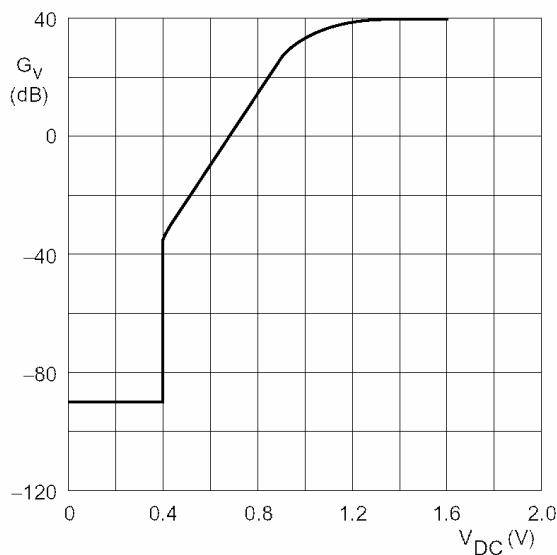

Figure 3. Gain control as a function of DC volume control.

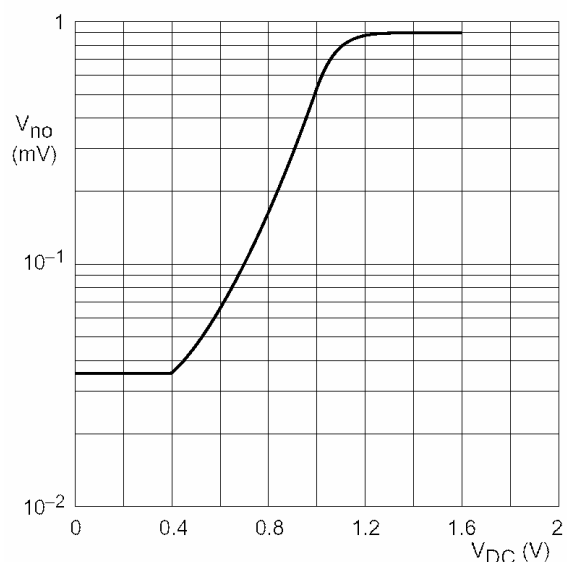

Figure 4. Noise output voltage as a function of DC volume control.

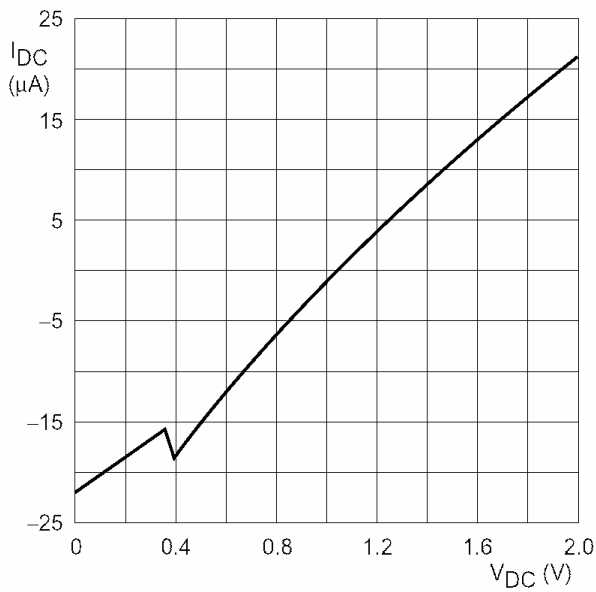

Figure 5. Control current as a function of DC volume control.

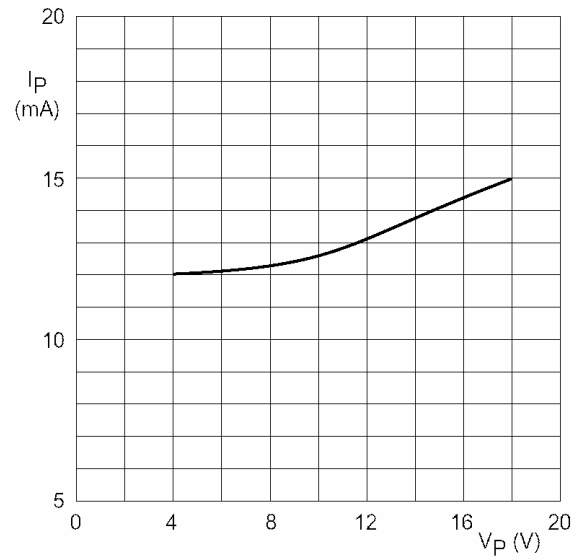

Figure 6. Quiescent current versus supply voltage.

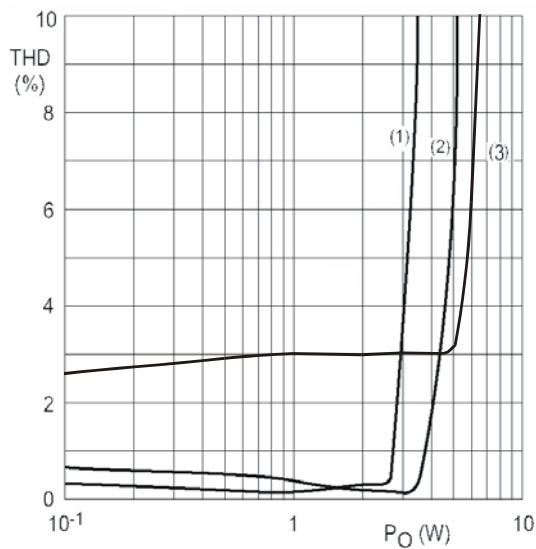

Figure 7. Total harmonic distortion versus output power.

- (1) $R_L = 16 \Omega$
- (2) $R_L = 8 \Omega$
- (3) $R_L = 4 \Omega, V_P = 12 V$

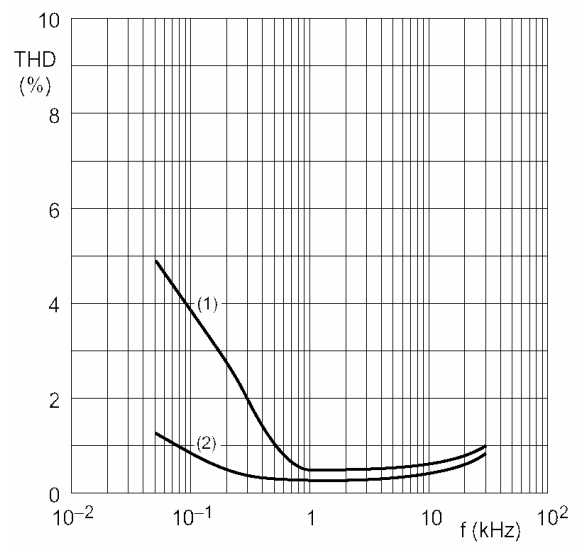

Figure 8. Total harmonic distortion versus frequency.

- $P_O = 0.1 W.$
- (1) $G_{v(max)} = 40 dB.$
- (2) $G_{v(max)} = 30 dB.$

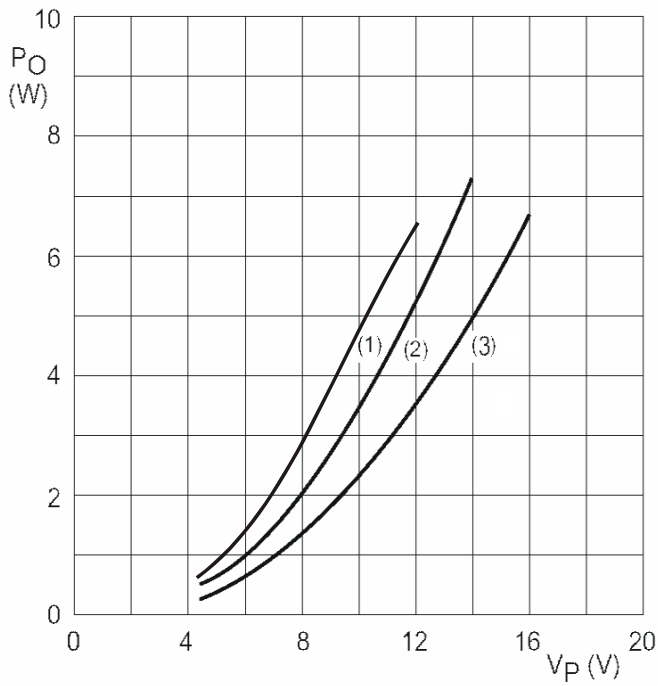

Figure 9. Output power versus supply voltage.
Measured at a THD of 10%. The maximum output power is limited by the maximum power dissipation and the maximum available output current.

- (1) $R_L = 4 \Omega$
- (2) $R_L = 8 \Omega$
- (3) $R_L = 16 \Omega$

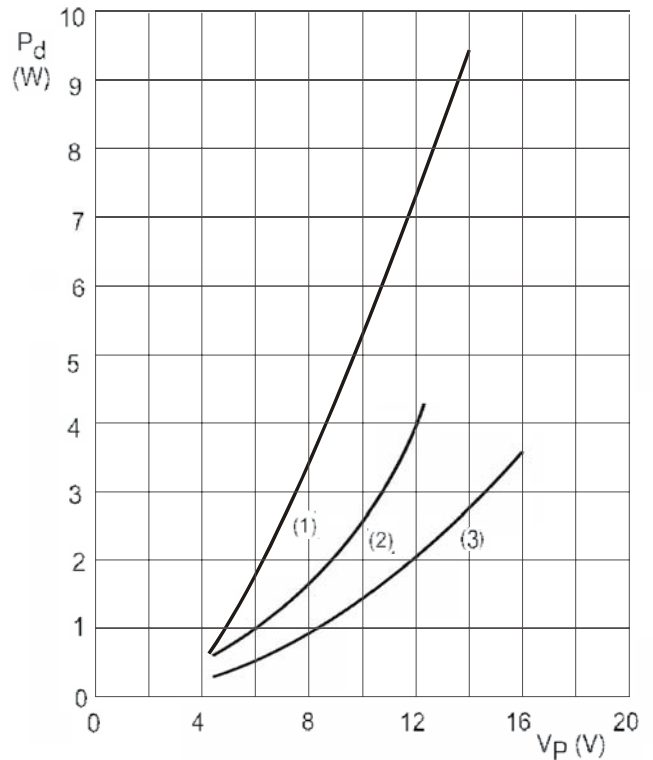

Figure 10. Total worst case power dissipation versus supply voltage.

- (1) $R_L = 4 \Omega$
- (2) $R_L = 8 \Omega$
- (3) $R_L = 16 \Omega$

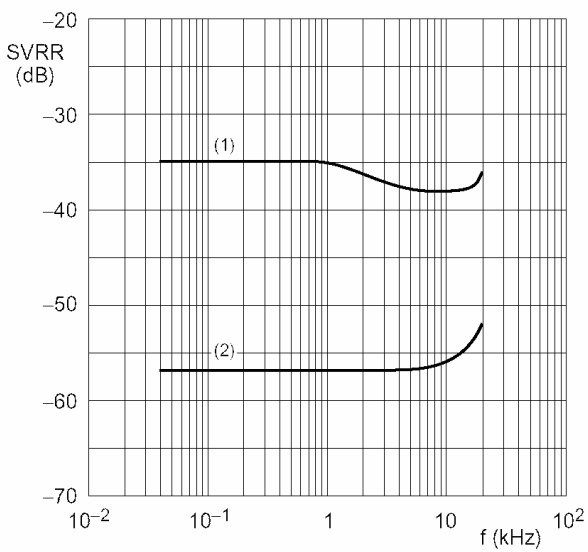

Fig.11 Supply voltage ripple rejection versus frequency.

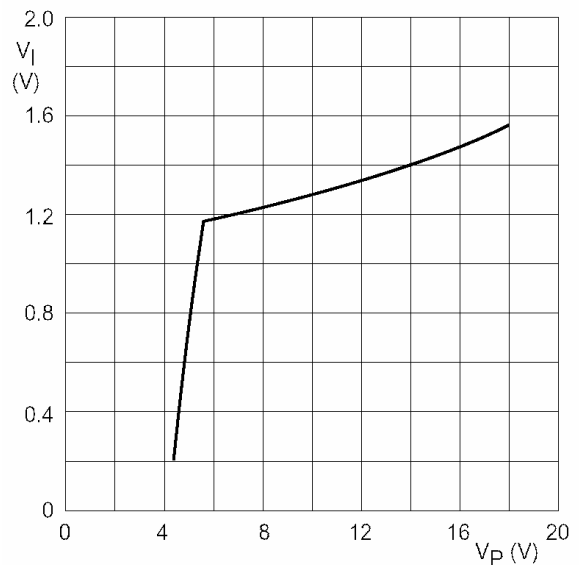
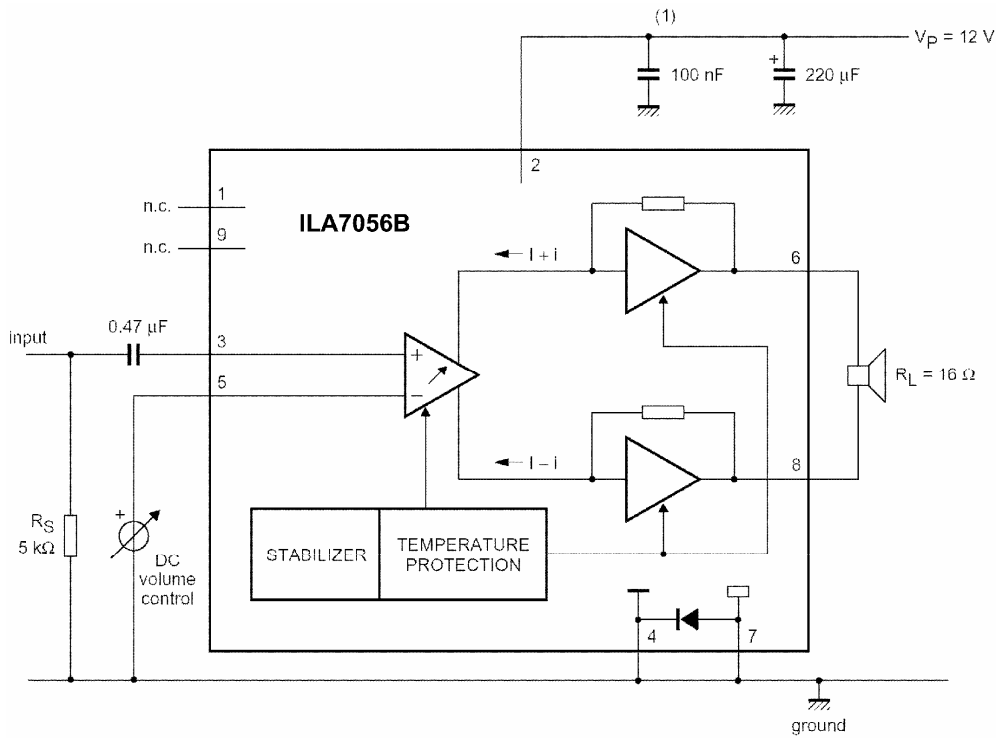

Fig.12 Input signal handling.



Test and application diagram

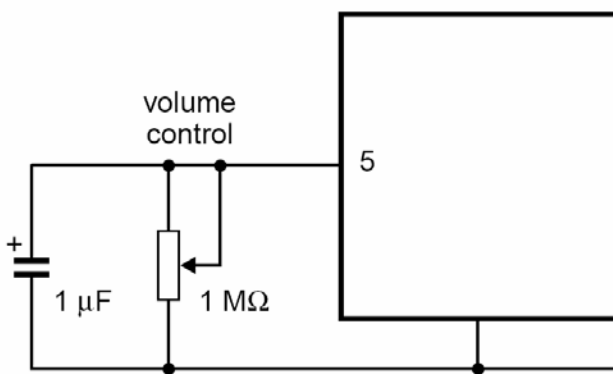

Fig.13 Application with potentiometer as volume control
Maximum gain = 34dB

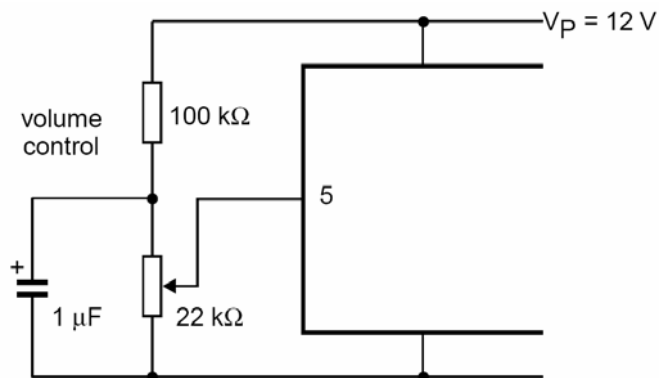

Fig.14 Application with potentiometer as volume control
Maximum gain = 40dB

- 9-Pin Plastic Power Single-in-Line (SIL-9MPF, SOT 110-1)

