

ILA7496L

2W+2W AMPLIFIER WITH DC VOLUME CONTROL

DESCRIPTION

The IL7496L is a stereo 2W+2W class AB power amplifier assembled in the @ Powerdip 14+3+3 package, specially designed for high quality sound, TV and Monitor applications. Features of the IL7496L include linear volume control, Stand-by and mute functions.

- 2W+2W OUTPUT POWER
RL = 8Ω @THD = 10% Vcc = 14V
- ST-BY AND MUTE FUNCTIONS)
- LOW TURN-ON TURN-OFF POP NOISE
- LINEAR VOLUME CONTROL DC COUPLED WITH POWER OP. AMP.
- NO BOUCHEROT CELL
- NO ST-BY RC INPUT NETWORK
- SINGLE SUPPLY RANGING UP TO 15V
- SHORT CIRCUIT PROTECTION
- THERMAL OVERLOAD PROTECTION
- INTERNALLY FIXED GAIN
- SOFT CLIPPING
- VARIABLE OUTPUT AFTER VOLUME CONTROL CIRCUIT
- POWERDIP (14+3+3) PACKAGE

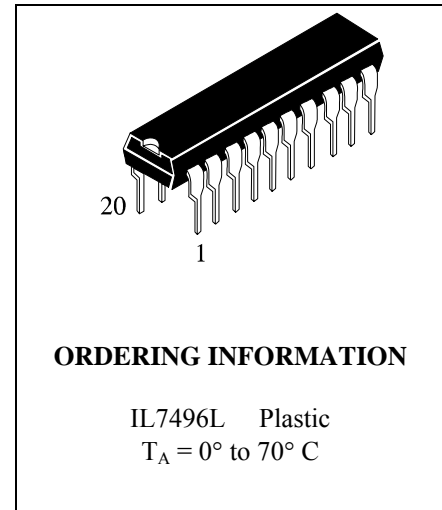

BLOCK DIAGRAM

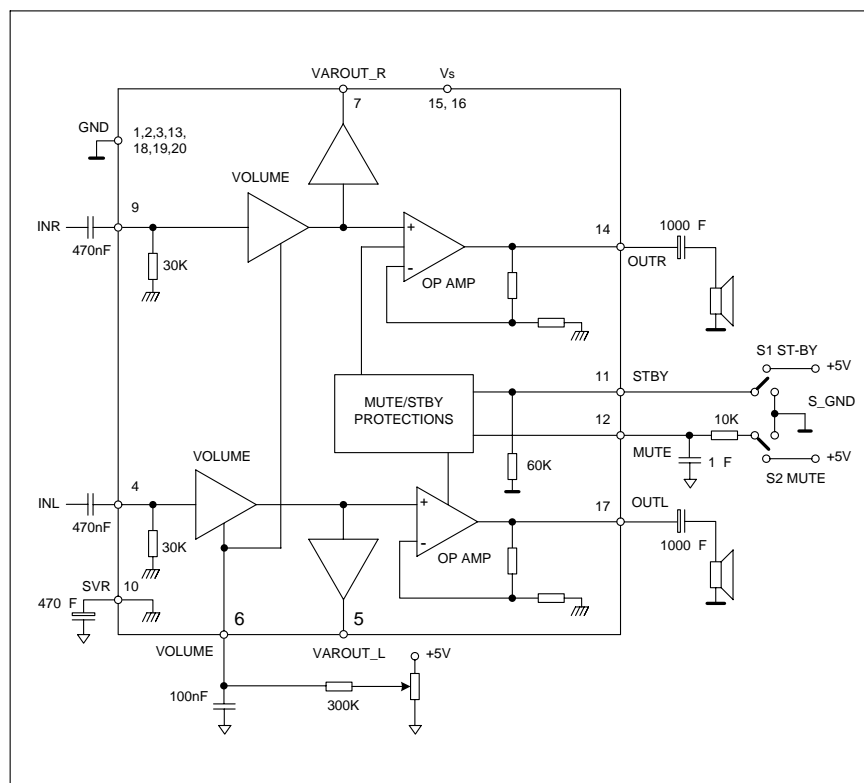

Absolute Maximum Ratings

Symbol	Parameter	Value	Unit
V _s	DC Supply Voltage	26	V
V _{IN}	Maximum Input Voltage	8	V _{pp}
T _{amb}	Ambient Operating Temperature	0 to 70	°C
T _{stg} , T _j	Storage and Junction Temperature	-40 to 150	°C
V ₆	Volume CTRL DC voltage	7	V

PIN CONNECTION

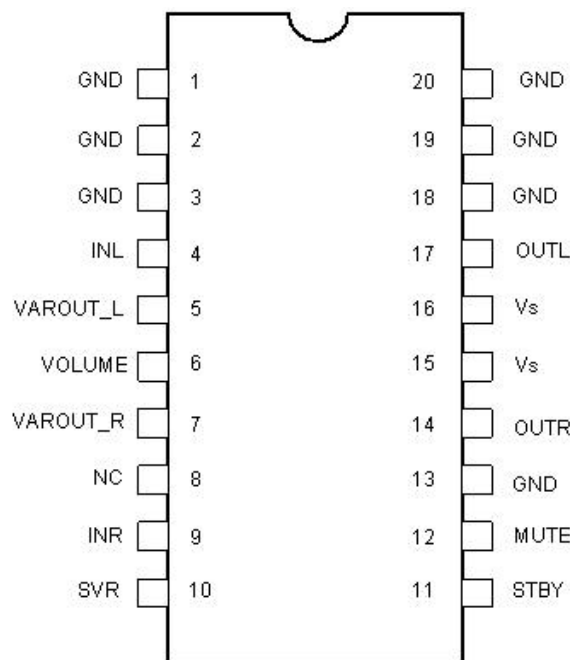

ELECTRICAL CHARACTERISTICS (Refer to the test circuit V_s = 14V, R_L = 80Ω, R_g = 50 Ω, T_{amb} = 25°C)

Symbol	Parameter	Test Condition	Min	Typ	Max	Unit
V _s	Supply Voltage Range		10		18	V
I _q	Total Quiescent Current			25	50	mA
DC/V _{os}	Output DC Offset Referred to SVR Potential	No Input Signal		200		mV
V _o	Quiescent Output Voltage			7		V
P _o	Output Power	THD = 10%, R _L = 8Ω THD = 1%, R _L = 8Ω	1.6	2		W
THD	Total Harmonic Distortion	G _v = 30dB, P _o = 1W, f = 1KHz			0.4	%
I _{peak}	Output Peak Current	(internally limited)	0.7	0.9		A
V _{in}	Input Signal				2.8	V _{rms}
G _v	Closed Loop Gain	Vol Ctrl > 4.5V	28.5	30	31.5	dB
G _{vLine}	Monitor Out Gain	Vol Ctrl > 4.5V, Z _{load} > 30KΩ	-1.5	0	1.5	dB
A _{Min} V _{OL}	Attenuation at Minimum Volume	Vol Ctrl < 0.5V	80			dB
BW				0.6		MHz

ELECTRICAL CHARACTERISTICS (continued)

Symbol	Parameter	Test Condition	Min	Typ	Max	Unit
eN	Total Output Noise	f = 20Hz to 22KHz Play, max volume		500	800	μV
		f = 20Hz to 22KHz Play, max attenuation		100	250	μV
		f = 20Hz to 22KHz Mute		60	150	μV
SR	Slew Rate		5	8		V/μs
R _i	Input Resistance		22.5	30		KΩ
R _{Var Out}	Variable Output Resistance			30	100	Ω
R _{load Var Out}	Variable Output Load		2			KΩ
SVR	Supply Voltage Rejection	f = 1kHz, max volume C _{SVR} = 470μF, V _{RIP} = 1Vrms	35	39		dB
		f = 1kHz, max attenuation C _{SVR} = 470μF, V _{RIP} = 1Vrms	55	65		dB
T _M	Thermal Muting			150		°C
T _s	Thermal Shut-down			160		°C

MUTE STAND-BY & INPUT SELECTION FUNCTIONS

V _{ST ON}	Stand-by ON Threshold		3.5			V
V _{ST OFF}	Stand-by OFF Threshold				1.5	V
V _{M ON}	Mute ON Threshold		3.5			V
V _{M OFF}	Mute OFF Threshold				1.5	V
I _{qST-BY}	Quiescent Current @ Stand-by			0.6	1	mA
A _{MUTE}	Mute Attenuation		50	65		dB
I _{stbyBIAS}	Stand-by bias current	Stand by on V _{ST-BY} = 5V V _{MUTE} = 5V		80		μA
		Play or Mute	-20	-5		μA
I _{muteBIAS}	Mute bias current	Mute		1	5	μA
		Play		0.2	2	μA

APPLICATION SUGGESTIONS

The recommended values of the external components are those shown on the application circuit of figure 1A. Different values can be used, the following table can help the designer.

COMPONENT	SUGGESTION VALUE	PURPOSE	LARGER THAN SUGGESTION	SMALLER THAN SUGGESTION
R1	300K	Volume control circuit	Larger volume regulation time	Smaller volume regulation time
R2	10K	Mute time constant	Larger mute on/off time	Smaller mute on/off time
P1	50K	Volume control circuit		
C1	1000μF	Supply voltage bypass		Danger of oscillation
C2	470nF	Input DC decoupling	Lower low frequency cutoff	Higher low frequency cutoff
C3	470nF	Input DC decoupling	Lower low frequency cutoff	Higher low frequency cutoff
C4	470μF	Ripple rejection	Better SVR	Worse SVR
C5	100nF	Volume control time constant	Larger volume regulation time	Smaller volume regulation time
C6	1000μF	Output DC decoupling	Lower low frequency cutoff	Higher low frequency cutoff
C7	1μF	Mute time constant	Larger mute on/off time	Smaller mute on/off time
C8	1000μF	Output DC decoupling	Lower low frequency cutoff	Higher low frequency cutoff
C9	100nF	Supply voltage bypass		Danger of oscillation

Figure 1A. Application Circuit

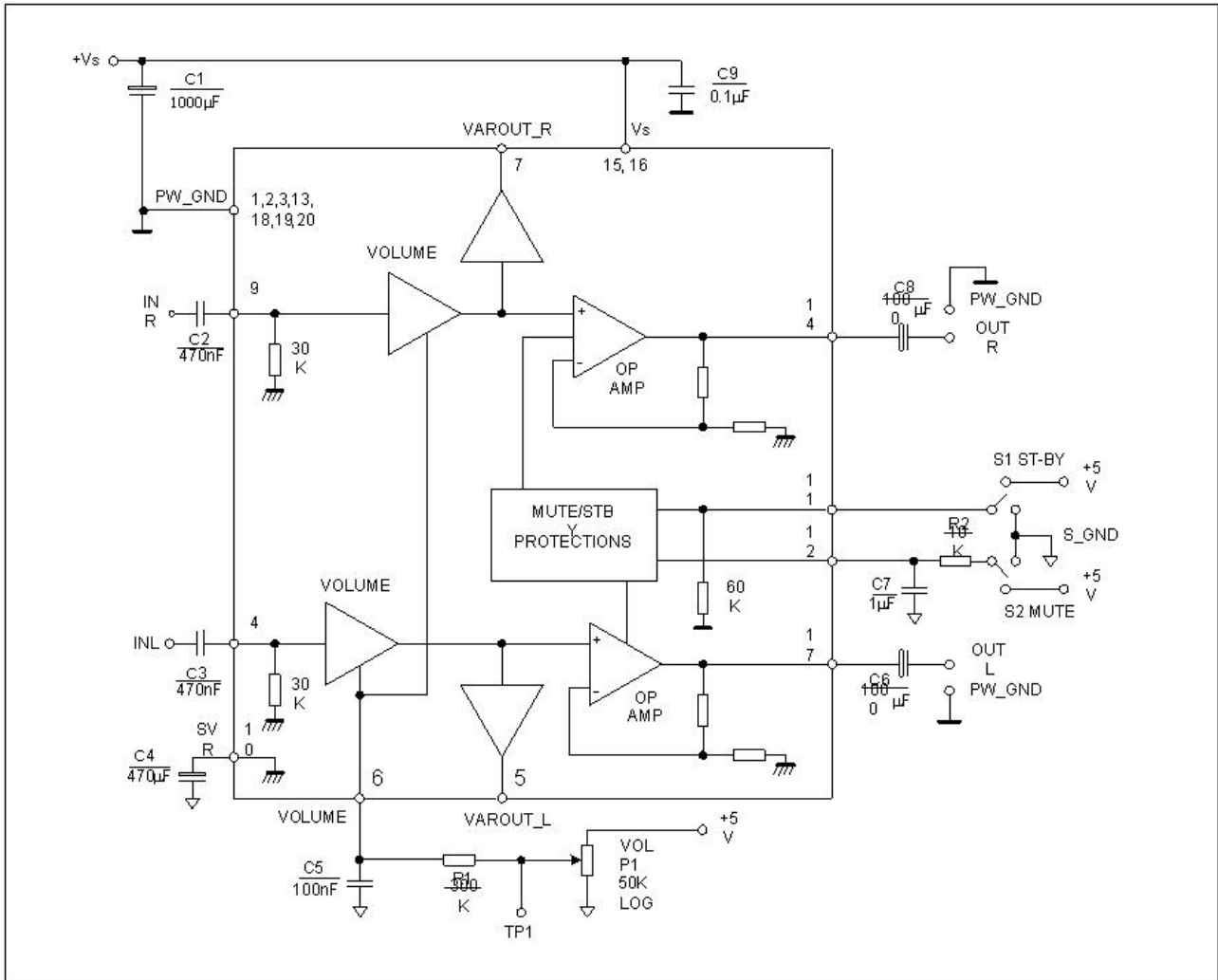

MUTE STAND-BY TRUTH TABLE

MUTE	ST-BY	OPERATING CONDITIO
H	H	STANDBY
L	H	STANDBY
H	L	MUTE
L	L	PLAY

Turn ON/OFF Sequences (for optimizing the POP performances)

A) USING MUTE AND STAND-BY FUNCTIONS

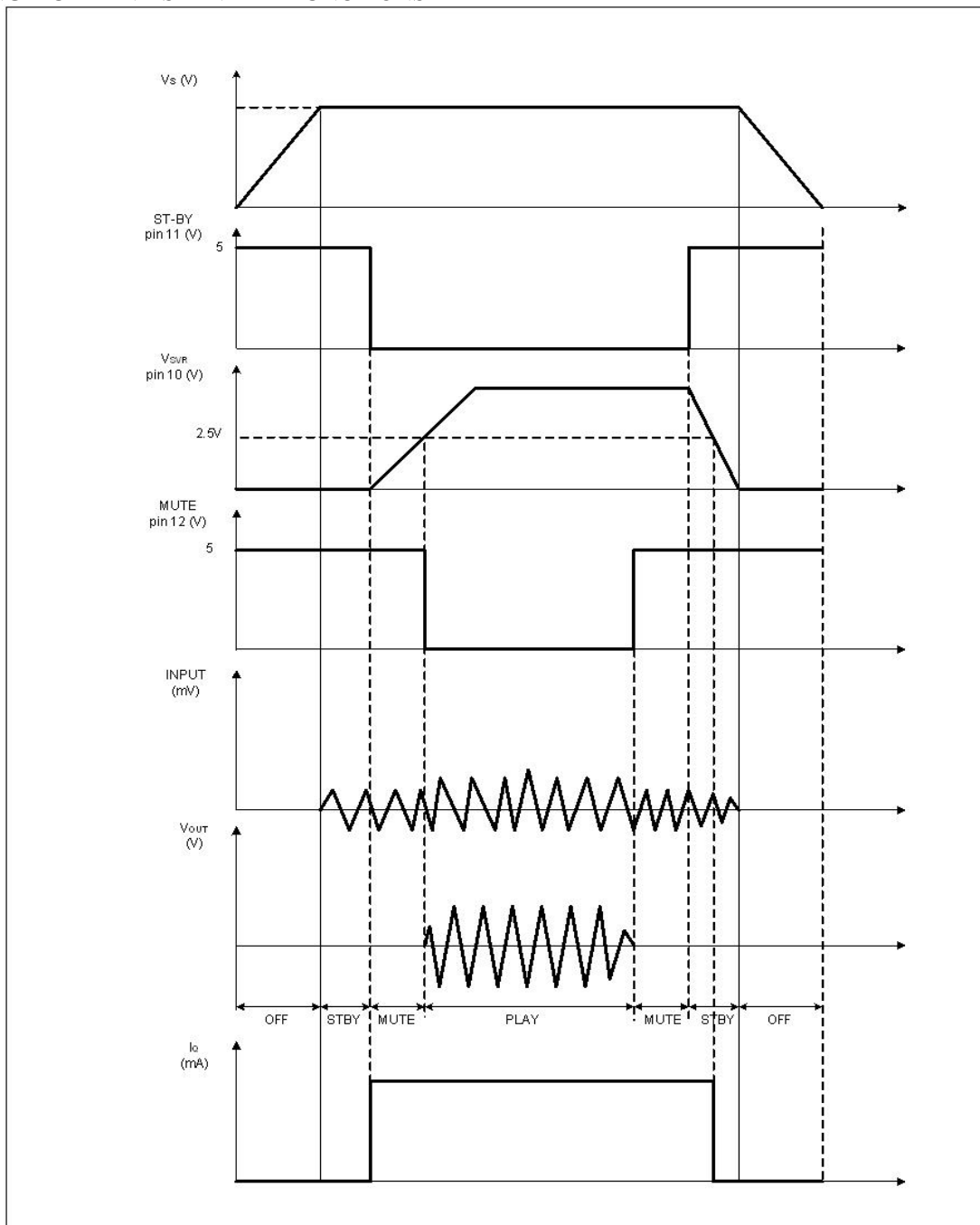

B) USING ONLY THE MUTE FUNCTION

To simplify the application, the stand-by pin can be connected directly to Ground. During the ON/OFF transitions it is recommended to respect the following conditions.

- At the turn-on, the transition mute-play must be made when the SVR pin is higher than 2.5V
- At the turn-off, the IL7496L must be brought to mute from the play condition when the SVR pin is higher than 2.5V

Quiescent current vs. Supply Voltage

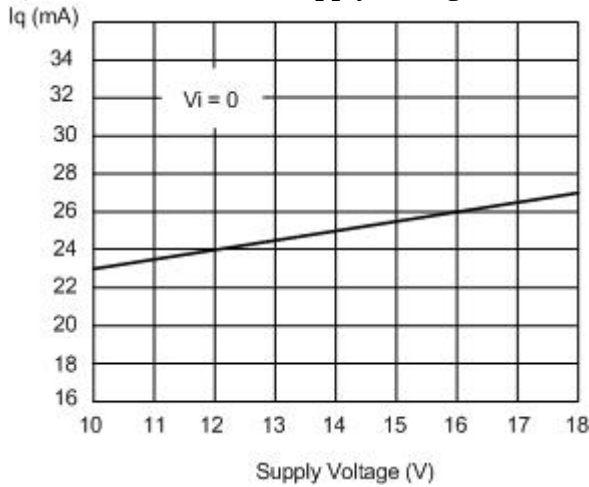

Output DC Voltage vs. Supply Voltage

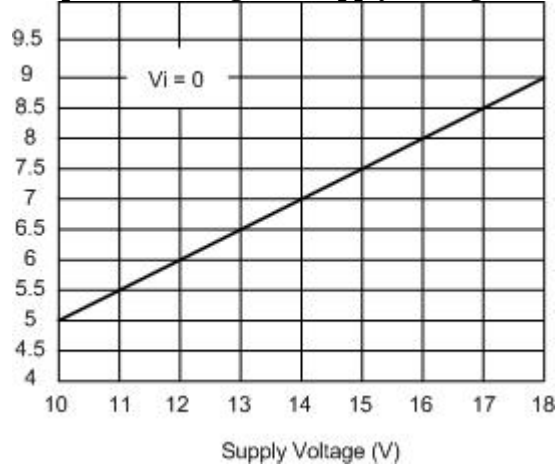

Output DC Offset vs. Supply Voltage

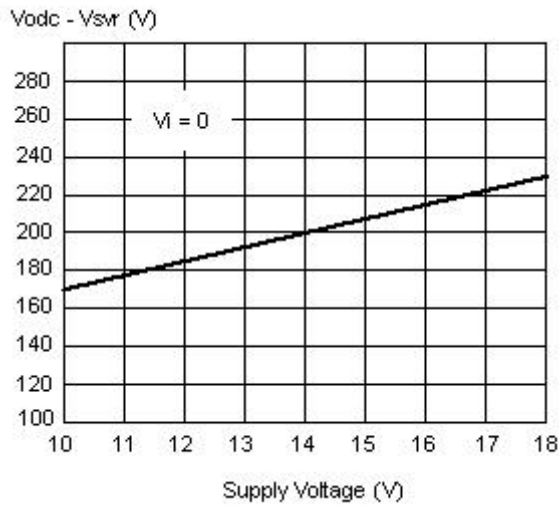

Output Power vs. Supply Voltage

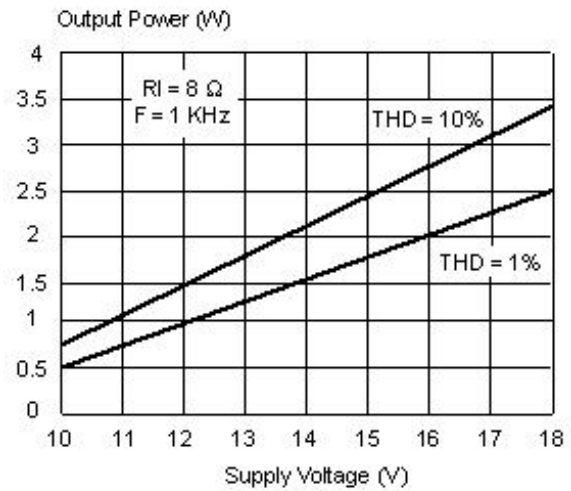

Distortion vs. Output Power

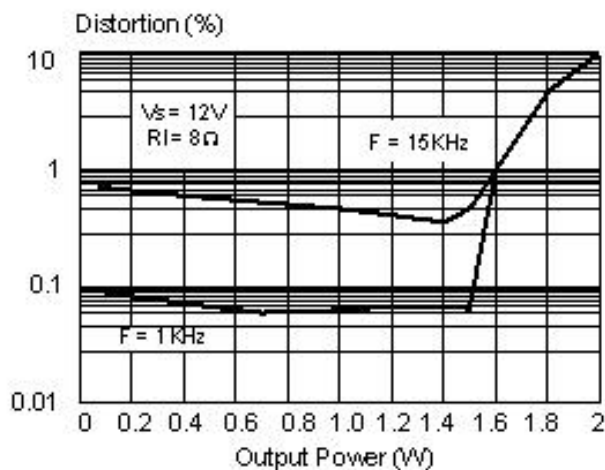

Closed Loop gain vs. Frequency

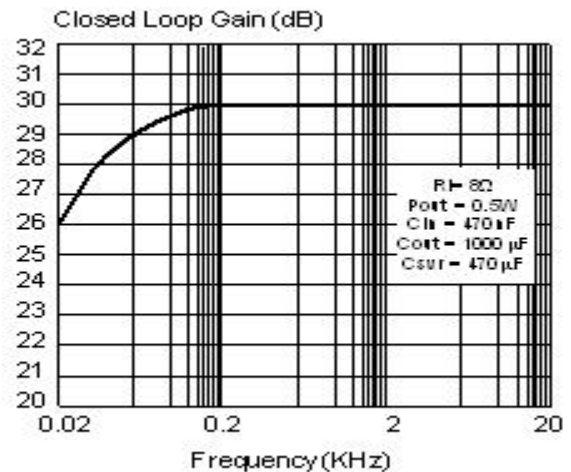

St-By Attenuation vs. Vpin 11

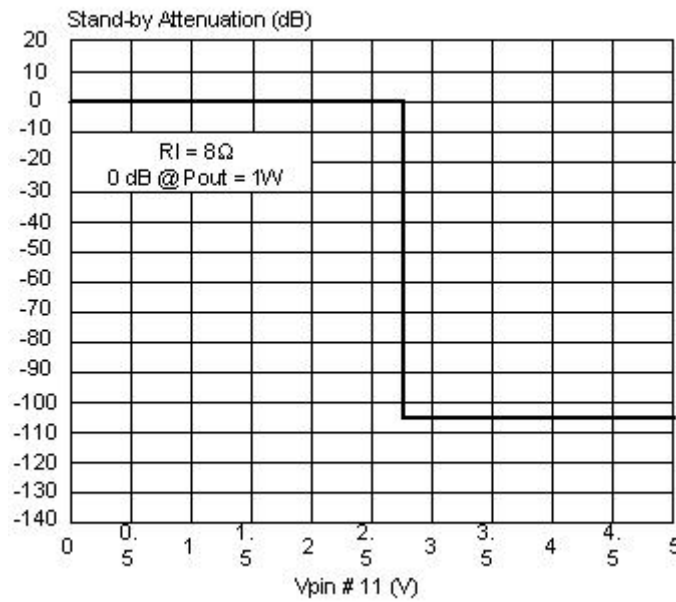

Mute Attenuation vs. Vpin 12

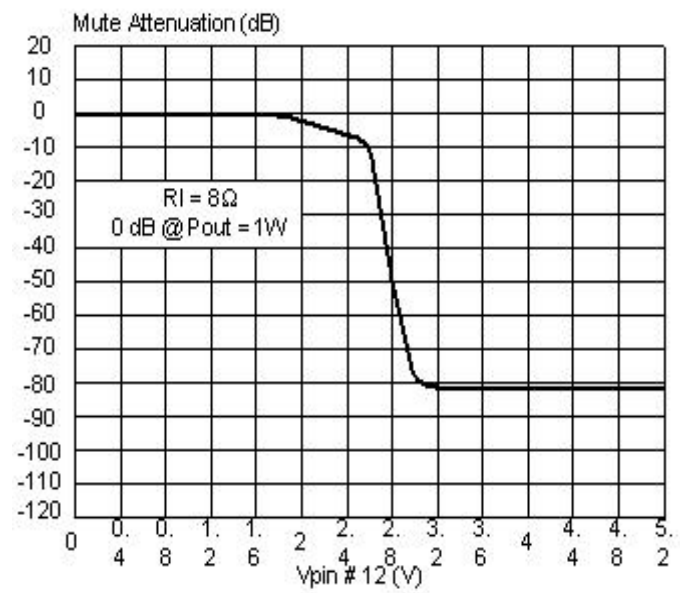

PACKAGE DIMENSION

**N SUFFIX PLASTIC DIP
(MS - 001AD)**

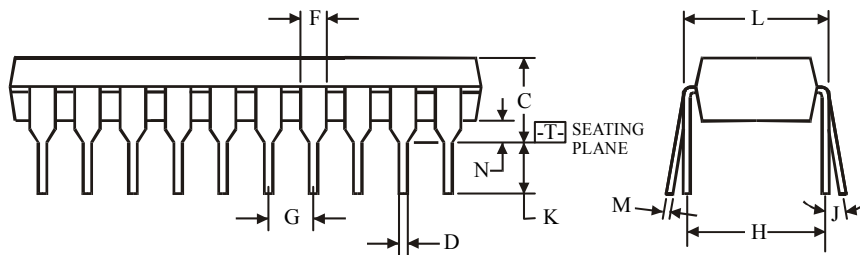
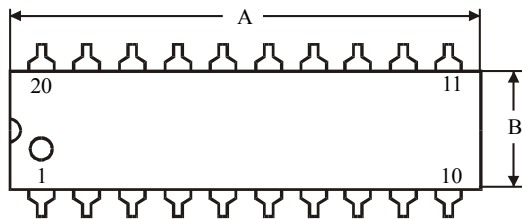
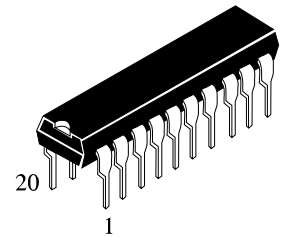

Symbol	Dimension, mm	
	MIN	MAX
A	24.89	26.92
B	6.10	7.11
C		5.33
D	0.36	0.56
F	1.14	1.78
G	2.54	
H	7.62	
J	0°	10°
K	2.92	3.81
L	7.62	8.26
M	0.20	0.36
N	0.38	

NOTES:

$\text{⌀} 0.25 (0.010) \text{Ⓜ} \text{T}$

- Dimensions "A", "B" do not include mold flash or protrusions.
Maximum mold flash or protrusions 0.25 mm (0.010) per side.