

CMOS general purpose timer

ILC555

The ILC555 is CMOS RC timers providing significantly improved performance over the standard SE/NE555 and 355 timers, while at the same time being direct replacements for those devices in most applications. Improved parameters include low supply current, wide operating supply voltage range, low THRESHOLD, TRIGGER and RESET currents, no crowbarring of the supply current during output transitions, higher frequency performance and no requirement to decouple CONTROL VOLTAGE for stable operation.

Specifically, the ILC555 is stable controller capable of producing accurate time delays of frequencies.

- Exact equivalent in most cases for SE/NE555.
- Low Supply Current.
- High speed operation – 500 kHz guaranteed.
- Wide operation supply voltage range – 2 to 18 volts.
- Timing from microseconds through hours.
- Operates in both astable and monostable modes.
- Adjustable duty cycle.
- High output source/sink driver can drive TTL/CMOS

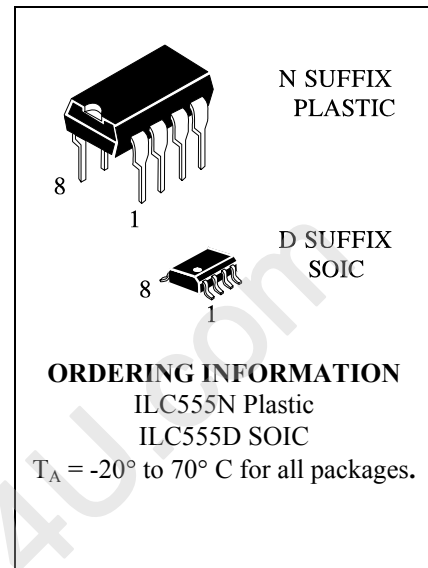

PIN ASSIGNMENT

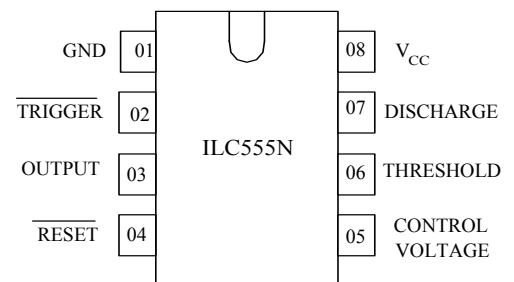

TRUTH TABLE

| THRESHOLD | TRIGGER | RESET | OUTPUT | DISCHARGE |
|----------------------|----------------------|-------|--------|-----------|
| X | X | L | L | ON |
| $> 2/3 \cdot V_{CC}$ | $> 1/3 \cdot V_{CC}$ | H | L | ON |
| $< 2/3 \cdot V_{CC}$ | $> 1/3 \cdot V_{CC}$ | H | STABLE | STABLE |
| X | $< 1/3 \cdot V_{CC}$ | H | H | OFF |

MAXIMUM RATINGS AND RECOMMENDED OPERATING CONDITIONS

| Parameter, unit | Symbol | Recommended operating conditions | | Maximum ratings | |
|---|-----------------------------|----------------------------------|------|-----------------|--------------|
| | | Value | | Value | |
| | | min | max | min | max |
| Supply Voltage, V | V_{CC} | 2.0 | 18.0 | 0 | 18.0 |
| Output Current, mA | I_O | - | 20 | - | 100 |
| Input Voltage, V | $V_{TH}, V_{TRIG}, V_{RST}$ | - | - | -0.3 | $V_{CC}+0.3$ |
| Power Dissipation, mW | P_D | - | - | - | 200 |
| Operating Temperature, °C | T_{OPR} | -20 | 70 | -20 | 85 |
| Storage Temperature, °C | T_{STG} | - | - | -65 | 150 |
| Lead Temperature, 1 mm from Case for 10 Seconds, °C | T_{SOLDER} | - | - | | 260 |

DC ELECTRICAL CHARACTERISTICS (Voltages Referenced to GND)

| Parameter, units | Symbol | Test Conditions | | Value | | Temperature, °C |
|-------------------------|-------------------|-----------------------------------|---------------------|----------------------|----------------------|-----------------|
| | | I _{OL} , I _{OH} | V _{CC} , B | min | max | |
| Threshold Voltage, V | V _{TH} | | 5.0 | 0.65 V _{CC} | 0.70 V _{CC} | 25±10 |
| | | | | 0.60 V _{CC} | 0.80 V _{CC} | -20, 70 |
| Trigger voltage, V | V _{TRIG} | | 5.0 | 0.31 V _{CC} | 0.36 V _{CC} | 25±10 |
| | | | | 0.28 V _{CC} | 0.40 V _{CC} | -20, 70 |
| Reset voltage, V | V _{RST} | | 2.0 | 0.4 | 1.0 | 25±10 |
| | | | 18.0 | | | |
| | | | 2.0 | 0.2 | 1.5 | -20, 70 |
| | | | 18.0 | | | |
| Control Voltage Lead, V | V _{CV} | | | 0.65 V _{CC} | 0.69 V _{CC} | 25±10 |
| | | | | 0.60 V _{CC} | 0.80 V _{CC} | -20, 70 |
| Output voltage Low, V | V _{OL} | I _{OL} = 3.2 mA | 5.0 | | 0.4 | 25±10 |
| | | I _{OL} = 20 mA | 15.0 | | 1.0 | |
| | | I _{OL} = 3.2 mA | 5.0 | | 0.6 | -20, 70 |
| | | I _{OL} = 20 mA | 15.0 | | 1.5 | |
| Output voltage High, V | V _{OH} | I _{OH} = -0.8 mA | 5.0 | 4.0 | | 25±10 |
| | | | 15.0 | 14.3 | | |
| | | | 5.0 | 3.5 | | -20, 70 |
| | | | 15.0 | 14.0 | | |
| Supply Current, µA | I _{CC} | | 2.0 | | 200 | 25±10 |
| | | | 18.0 | | 300 | |
| | | | 2.0 | | 400 | -20, 70 |
| | | | 18.0 | | 600 | |

AC ELECTRICAL CHARACTERISTICS

| Parameter, unit | Symbol | Test Conditions | | Value | | Temperature, °C |
|--------------------------------|-------------------------------------|--|---------------------|-------|------|-----------------|
| | | R _L , C _L | V _{CC} , V | Min | Max | |
| Rise (Fall) Time of Output, ns | t _{THL} , t _{TLH} | R _L = 10 MΩ, C _L = 10 pF | 5.0 | 35 | 75 | 25±10 |
| | | | | 70 | 150 | -20, 70 |
| Guaranteed Max Osc Freq, kHz | f _{MAX} | Astable Operation | 2.0-18.0 | 500 | | 25±10 |
| | | | | 200 | | -20, 70 |
| Initial accuracy, % | | | | 5 | | |
| Drift with Temperature, %/°C | αf | R _L = 1 - 100 kΩ, C _L = 0.1 μF | 5.0 | | 0.02 | -20, 70 |
| | | | | 10.0 | 0.03 | |
| | | | | 15.0 | 0.06 | |
| Drift with Supply Voltage, %/B | Δf | | 5.0 | | 3 | 25±10 |
| | | | | | 6 | -20, 70 |



Figura 1. Block Diagram



Figura 2. Switching Waveforms

**N SUFFIX PLASTIC DIP
(MS – 001BA)**

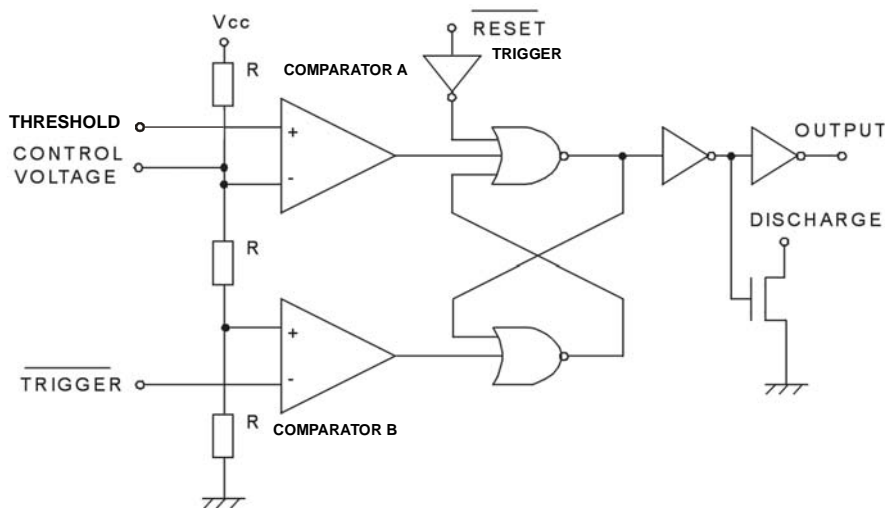

$\oplus 0.25 (0.010) \text{ (M) T}$

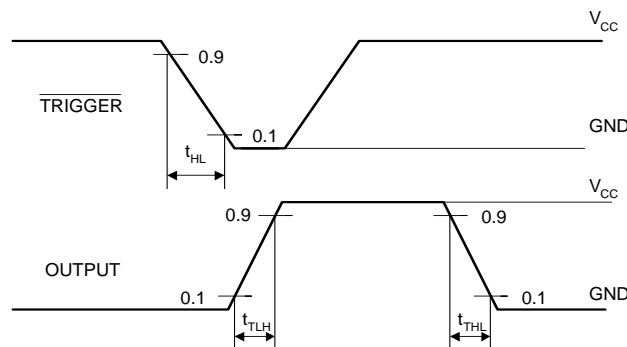
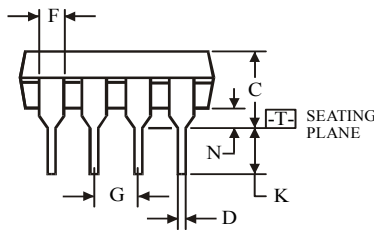
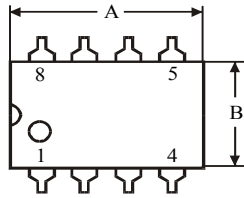
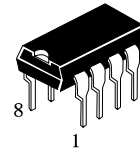
| Symbol | Dimension, mm | |
|--------|---------------|-------|
| | MIN | MAX |
| A | 8.51 | 10.16 |
| B | 6.1 | 7.11 |
| C | | 5.33 |
| D | 0.36 | 0.56 |
| F | 1.14 | 1.78 |
| G | 2.54 | |
| H | 7.62 | |
| J | 0° | 10° |
| K | 2.92 | 3.81 |
| L | 7.62 | 8.26 |
| M | 0.2 | 0.36 |
| N | 0.38 | |

NOTES:

- Dimensions “A”, “B” do not include mold flash or protrusions.
Maximum mold flash or protrusions 0.25 mm (0.010) per side.

**D SUFFIX SOIC
(MS - 012AA)**

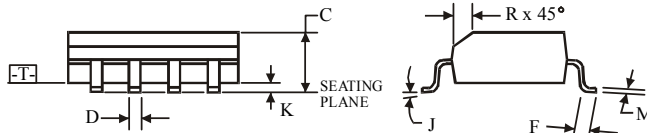
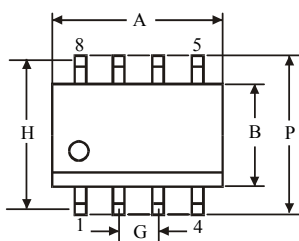
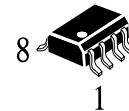

$\oplus 0.25 (0.010) \text{ (M) T C (M)}$

| Symbol | Dimension, mm | |
|--------|---------------|------|
| | MIN | MAX |
| A | 4.8 | 5 |
| B | 3.8 | 4 |
| C | 1.35 | 1.75 |
| D | 0.33 | 0.51 |
| F | 0.4 | 1.27 |
| G | 1.27 | |
| H | 5.72 | |
| J | 0° | 8° |
| K | 0.1 | 0.25 |
| M | 0.19 | 0.25 |
| P | 5.8 | 6.2 |
| R | 0.25 | 0.5 |

NOTES:

- Dimensions A and B do not include mold flash or protrusion.
- Maximum mold flash or protrusion 0.15 mm (0.006) per side for A; for B - 0.25 mm (0.010) per side.