

ILC556N

General purpose dual timer

ILC556N/D is designed to be used: as high-precision pulse oscillator with adjustable frequency and on-off time ratio; for producing accurate time delays using external resistors and capacitors; as a timer in domestic appliances, in measuring equipment, computers; as functional units in electronic instruments. The timer may be used as oscillator producing accurate time delays and frequencies.

In astable mode the pulse width of each circuit is controlled by one external resistor and capacitor. In monostable mode, when used as oscillator, its own frequency of oscillation and on-off time ratio are controlled by two external resistors and one capacitor.

Unlike bipolar timer, CONTROL VOLTAGE output does not require any capacitor decoupling. TRIGGER, RESET inputs are active as per low level. Output inverter provides sufficient drain and source currents to control TTL-loads, and provides minimum bias when controlling CMOS-loads. Input voltage levels are compatible with standard CMOS levels.

- Output voltage levels are compatible with input levels of CMOS ICs.
- Supply current: not more than 600 μ A.
- Supply voltage range: from 2.0 to 18V.
- Input current: 50, 100 pA at T=25 °C.
- Output current: 20 mA.
- Timing from microseconds to hours.
- Operates both in astable and monostable modes.
- Adjustable duty cycle.
- Temperature stability: 0.06%/°C.
- Latch current not less than 100 mA at T=70 °C.
- Allowed static potential value: not less than 2000V (HBM) and not less than 200 V (MM).

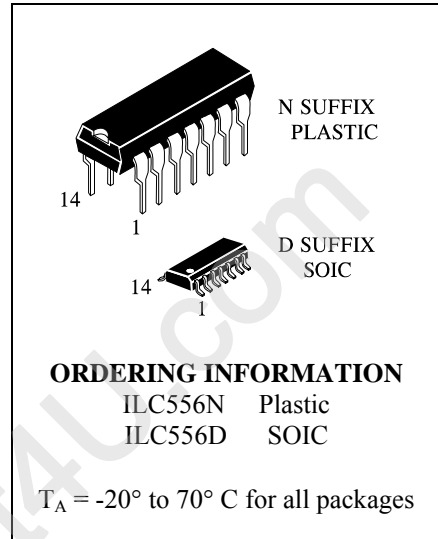

Pin Configuration

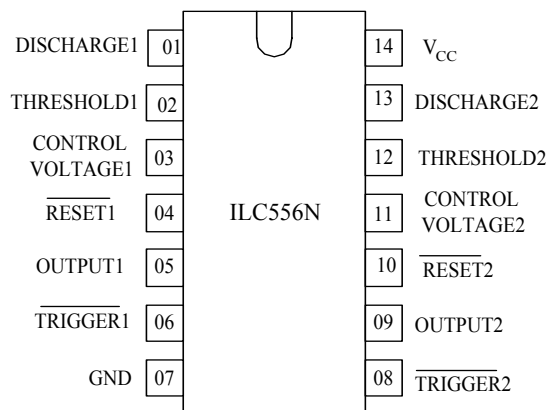

Figure 1

Truth Table

THRESHOLD	$\overline{\text{TRIGGER}}$	$\overline{\text{RESET}}$	OUTPUT	DISCHARGE
X	X	L	L	ON
$> 2/3 \odot V_{CC}$	$> 1/3 \odot V_{CC}$	H	L	ON
$< 2/3 \odot V_{CC}$	$> 1/3 \odot V_{CC}$	H	STABLE	STABLE
X	$< 1/3 \odot V_{CC}$	H	H	OFF

Maximum ratings and recommended operating conditions

Parameter, unit	Symbol	Recommended operating conditions		Maximum ratings	
		Typical		Typical	
		Min	Max	Min	Max
Supply voltage, V	V_{CC}	2.0	18.0	0	18.0
Output current, mA	I_O	-	20	-	100
Input voltage, V	$V_{TH}, V_{TRIG}, V_{RST}$	-	-	-0.3	$V_{CC}+0.3$
Power dissipation, mW	P_D	-	-	-	300
Operating temperature, °C	T_{OPR}	-20	70	-20	85
Storage temperature, °C	T_{STG}	-	-	-65	150
Lead solder temperature, °C (10 sec max)	T_{SOLDER}	-	-		260

AC characteristics

Parameter	Symbol	Condition		Typical		Temperature, °C
		I _{OL} , I _{OH}	V _{CC} , V	Min	Max	
Threshold voltage, V _{CC}	V _{TH}		5.0	0.65	0.70	25±10
				0.60	0.80	-20, 70
Trigger voltage, V _{CC}	V _{TRIG}		5.0	0.31	0.36	25±10
				0.28	0.40	-20, 70
Reset voltage, V	V _{RST}		2.0	0.4	1.0	25±10
			18.0			
			2.0	0.2	1.5	-20, 70
			18.0			
Control voltage, V _{CC}	V _{CV}			0.65	0.69	25±10
				0.60	0.80	-20, 70
Output voltage, LOW, V	V _{OL}	I _{OL} = 3.2 mA	5.0		0.4	25±10
		I _{OL} = 20 mA	15.0		1.0	
		I _{OL} = 3.2 mA	5.0		0.6	-20, 70
		I _{OL} = 20 mA	15.0		1.5	
Output voltage, HIGH, V	V _{OH}	I _{OH} = -0.8 mA	5.0	4.0		25±10
			15.0	14.3		
			5.0	3.5		-20, 70
			15.0	14.0		
Supply current , μA	I _{CC}		2.0		400	25±10
			18.0		600	
			2.0		800	-20, 70
			18.0		1000	

DC characteristics

Parameter	Symbol	Condition		Typical		Temperature °C	
		R_L, C_L	V_{CC}, V	Min	Max		
Clock rise and fall time, ns	t_{THL}, t_{TLH}	$R_L = 10 \text{ MOhm}, C_L = 10 \text{ pF}$	5.0	-	75	25 ± 10	
				-	150	-20, 70	
Maximum oscillation frequency, kHz	f_{MAX}	Monostable mode	2.0-18.0	500		25 ± 10	
				200		-20, 70	
Initial frequency, %				5			
Oscillation frequency temperature ratio, %/°C	αf	$R_L = 1 - 100 \text{ kOhm}, C_L = 0.1 \text{ }\mu\text{F}$	5.0		0.02	-20, 70	
							0.03
							0.06
Oscillation frequency instability, %/V	Δf		5.0		3	25 ± 10	
						6	-20, 70

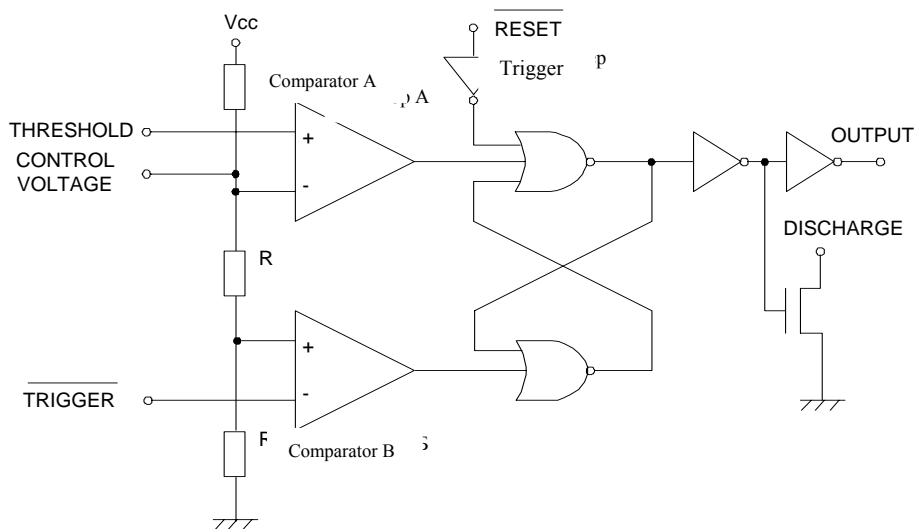

Figure 2 – Block diagram

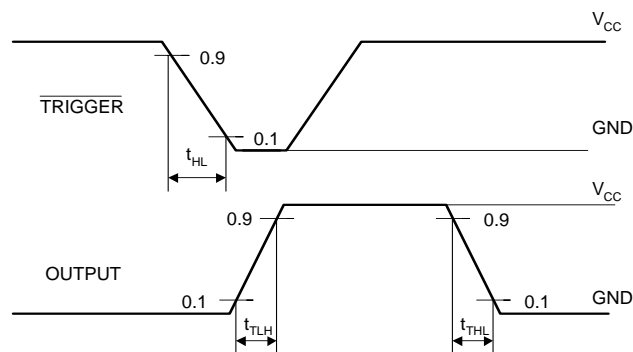
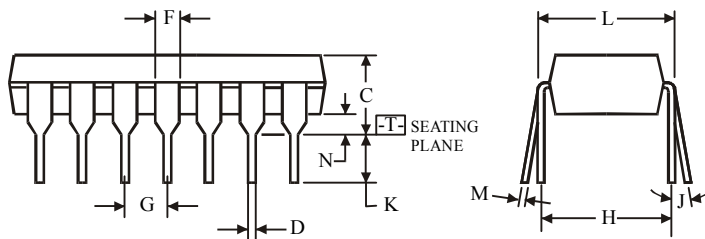
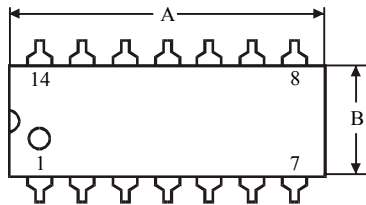
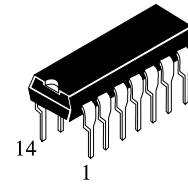

Figure 3 – Time diagram

**N SUFFIX PLASTIC DIP
(MS - 001AA)**



$$\oplus 0.25 (0.010) \text{ (M) T}$$

NOTES:

- Dimensions "A", "B" do not include mold flash or protrusions.
Maximum mold flash or protrusions 0.25 mm (0.010) per side.

Symbol	Dimension, mm	
	MIN	MAX
A	18.67	19.69
B	6.1	7.11
C		5.33
D	0.36	0.56
F	1.14	1.78
G	2.54	
H	7.62	
J	0°	10°
K	2.92	3.81
L	7.62	8.26
M	0.2	0.36
N	0.38	

**D SUFFIX SOIC
(MS - 012AB)**

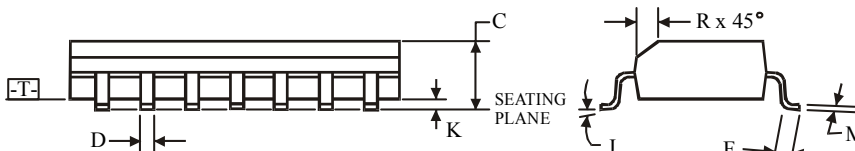
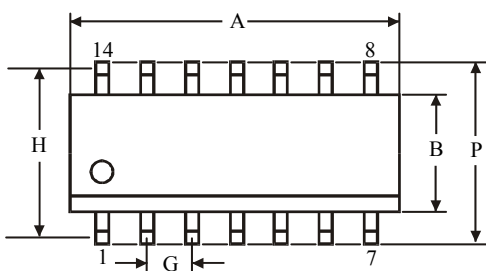
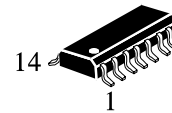

$$\oplus 0.25 (0.010) \text{ (M) T C (M)}$$

NOTES:

- Dimensions A and B do not include mold flash or protrusion.
- Maximum mold flash or protrusion 0.15 mm (0.006) per side for A; for B - 0.25 mm (0.010) per side.

Symbol	Dimension, mm	
	MIN	MAX
A	8.55	8.75
B	3.8	4
C	1.35	1.75
D	0.33	0.51
F	0.4	1.27
G	1.27	
H	5.27	
J	0°	8°
K	0.1	0.25
M	0.19	0.25
P	5.8	6.2
R	0.25	0.5