

ILC 6370/71

SOT-89 Step up Switching Regulator with Shutdown



General Description

50mA boost converter in 5-lead SOT-89 package. Only 3 external components are needed to complete the switcher design, and frequency options of 50, 100, and 180kHz gives the designer the ability to trade off system needs with switcher design size.

87% max duty cycle gives conversion efficiencies of 85%.

Standard voltage options of 2.5V, 3.3V, and 5.0V at $\pm 2.5\%$ accuracy feature on-chip phase compensation and soft-start design.

ILC6371 drives an external transistor for higher current switcher design, with all of the features and benefits of the ILC6370.

Features

- ◆ 85% efficiency at 50mA
- ◆ Start-up voltages as low as 900mV
- ◆ $\pm 2.5\%$ accurate outputs
- ◆ Complete switcher design with only 3 external components
- ◆ 50, 100 and 180kHz switching frequency versions available
- ◆ Shutdown to 0.5 μ A
- ◆ External transistor option allows several hundred milliamp switcher design

Applications

- ◆ Cellular Phones, Pagers
- ◆ Portable Cameras and Video Recorders
- ◆ Palmtops and PDAs

Block Diagram

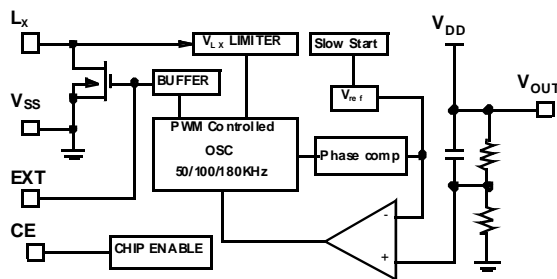

V_{DD} is internally connected to the $V_{O\text{UT}}$ pin.

Pin-Package Configurations

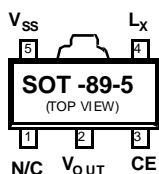

ILC6370

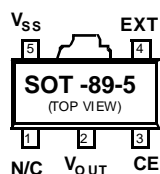

ILC6371

Ordering Information*

ILC6370CP-25	2.5V $\pm 2.5\%$ @50kHz
ILC6370CP-33	3.3V $\pm 2.5\%$ @50kHz
ILC6370CP-50	5.0V $\pm 2.5\%$ @50kHz
ILC6370BP-25	2.5V $\pm 2.5\%$ @100kHz
ILC6370BP-33	3.3V $\pm 2.5\%$ @100kHz
ILC6370BP-50	5.0V $\pm 2.5\%$ @100kHz
ILC6370AP-25	2.5V $\pm 2.5\%$ @180kHz
ILC6370AP-33	3.3V $\pm 2.5\%$ @180kHz
ILC6370AP-50	5.0V $\pm 2.5\%$ @180kHz
ILC6371CP-25	2.5V $\pm 2.5\%$ @50kHz, external xtor
ILC6371CP-33	3.3V $\pm 2.5\%$ @50kHz, external xtor
ILC6371CP-50	5.0V $\pm 2.5\%$ @50kHz, external xtor
ILC6371BP-25	2.5V $\pm 2.5\%$ @100kHz, external xtor
ILC6371BP-33	3.3V $\pm 2.5\%$ @100kHz, external xtor
ILC6371BP-50	5.0V $\pm 2.5\%$ @100kHz, external xtor
ILC6371AP-25	2.5V $\pm 2.5\%$ @180kHz, external xtor
ILC6371AP-33	3.3V $\pm 2.5\%$ @180kHz, external xtor
ILC6371AP-50	5.0V $\pm 2.5\%$ @180kHz, external xtor
Standard Product offering comes in tape and reel, quantity 1000 per reel, orientation right for SOT-89	

Absolute Maximum Ratings (T_A = 25°C)

Parameter	Symbol	Ratings	Units
V _{OUT} Input Voltage Pin	V _{OUT}	12	V
CE Input Voltage	V _{CE}	12	V
Voltage on pin L _X	V _{LX}	12	V
Current on pin L _X	I _{LX}	400	mA
Voltage on pin EXT	V _{EXT}	0.3 ~V _{OUT} +0.3	V
Current pin EXT	I _{EXT}	+50	mA
Continuous Total Power Dissipation (SOT-89-5)	P _D	500	mW
Operating Ambient Temperature	T _{OPR}	-30~+80	°C
Storage Temperature	T _{STG}	-40~+125	°C

Electrical Characteristics ILC6370BP-50

V_{OUT} = 5.0V, F_{OSC} = 100kHz, T_A = 25°C, Test Circuit of figure 1

Parameter	Symbol	Conditions	Min	Typ	Max	Units
Output Voltage	V _{OUT}		3.218	3.300	3.383	V
Input Voltage	V _{IN}				10	V
Oscillation Startup Voltage	V _{ST2}	L _X :10kΩ Pull-up to.5V, V _{OUT} = V _{ST}	500	600		mA
Operation Startup Voltage	V _{ST1}	I _{OUT} +1mA		55	86	μA
Supply Current 1	I _{DD1}	L _X :10kΩ Pull-up to.5V, V _{OUT} = 4.5V		1.5	2.5	μA
Supply Current 1	I _{DD2}	Open Loop Measurement, V _{S/D} = V _{IN} , V _{LX} =V _{IN} -0.4V, V _{OUT} = 3V		0.64	0.85	Ω
L _X Switch-On Resistance	R _{SWON}	Open Loop Measurement, V _{OUT} = V _{IN} , V _{LX} = 0V			2.0	μA
L _X Leakage Current	I _{LXL}	Measure Waveform at EXT pin V _{IN} = 3.6V I _{OUT} = 20mA	255	300	345	KHz
Oscillator Frequency	F _{OSC}			100		%
Maximum Duty Ratio	MAXDTY	No Load	10	17	25	%
Satndb-by Current	I _{STB}			95		%
CE "High " Voltage	V _{CEH}	Minimum V _{IN} When V _{ref} does not start up	1		1.8	V
CE "Low " Voltage	V _{CEL}	V _{ref} rises to 0V from 0.9V	6.0	10.0	16.0	msec

Note: Unless otherwise specified, V_{IN} = V_{OUT} x 0.6, I_{OUT} = 50mA. See Schematic, figure 1.

Electrical Characteristics ILC6370BP-50

$V_{OUT} = 5.0V$, $F_{OSC} = 100kHz$, $T_A = 25^{\circ}C$; Test Circuit of figure 1

Parameter	Symbol	Conditions	Min	Typ	Max	Units
CE "High" Current	I_{CEH}	L_X : 10k Ω pull-up to 5V, $V_{CE} = V_{OUT} = 4.5V$			0.25	μA
CE "Low" Current	I_{CEL}	L_X : 10k Ω pull-up to 5V, $V_{OUT} = 4.5V$, $V_{CE} = 0V$			-0.25	μ
L_X Limit Voltage	V_{LXLMT}	L_X : 10k Ω pull-up to 5V, $V_{OUT} = 4.5V$, $F_{OSC} > F_{OSC} \times 2^{(1)}$	0.7		1.1	V
Efficiency	EFFI			85		%

1. Switching frequency determined by delay time of internal comparator to turn L_X "OFF," and minimum "ON" time as determined by MAXDTY spec.

Electrical Characteristics ILC6371BP-50

$V_{OUT} = 5.0V$, $F_{OSC} = 100kHz$, $T_A = 25^{\circ}C$; Test Curcuit of figure 2.

Parameter	Symbol	Conditions	Min	Typ	Max	Units
Output Voltage	V_{OUT}		4.87 5	5.000	5.125	V
Input Voltage	V_{IN}				10	V
Oscillation Startup Voltage	V_{ST}	EXT: 10k Ω pull-up to 5V, $V_{OUT} = V_{ST}$			0.8	V
Supply Current 1	$I_{DD 1}$	EXT: 10k Ω pull-up to 5V, $V_{OUT} = 4.5V$		38.4	64.1	μA
Supply Current 2	$I_{DD 2}$	EXT: 10k Ω pull-up to 5V, $V_{OUT} = 5.5V$		6.9	13.8	μA
EXT "High" On-Resistance	R_{EXTH}	EXT: 10k Ω pull-up to 5V, $V_{OUT} = 4.5V$, $V_{EXT} = 4.1V$		30	50	Ω
EXT "Low" On-Resistance	R_{EXTL}	$V_{EXT} = 0.4V$, $V_{OUT} = 5.5V$		30	50	Ω
Oscillator Frequency	F_{OSC}	EXT: 10k Ω pull-up to 5V, $V_{OUT} = 4.5V$, Measuring of EXT pin	85	100	115	kHz
Maximum Duty Ratio	MAXDTY	EXT: 10k Ω pull-up to 5V, $V_{OUT} = 4.5V$, Measuring of EXT pin	80	87	92	%
Stand-by Current	I_{STB}	EXT: 10k Ω pull-up to 5V, $V_{OUT} = 4.5V$			0.5	μA
CE "High" Voltage	V_{CEH}	EXT: 10k Ω pull-up to 5V, $V_{OUT} = 4.5V$, Existance of L_X Oscillation	0.75			V
CE "Low" Voltage	V_{CEL}	EXT: 10k Ω pull-up to 5V, $V_{OUT} = 4.5V$, Stopped L_X Oscillation			0.20	V
CE "High" Current	I_{CEH}	EXT: 10k Ω pull-up to 5V, $V_{OUT} = V_{CE} = 4.5V$			0.25	μA
CE "Low" Current	I_{CEL}	EXT: 10k Ω pull-up to 5V, $V_{OUT} = 4.5V$, $V_{CE} = 0V$			-0.25	μA
Efficiency	EFFI			85		%
Slow Start Time	T_{SS}			10		msec

Applications Circuits

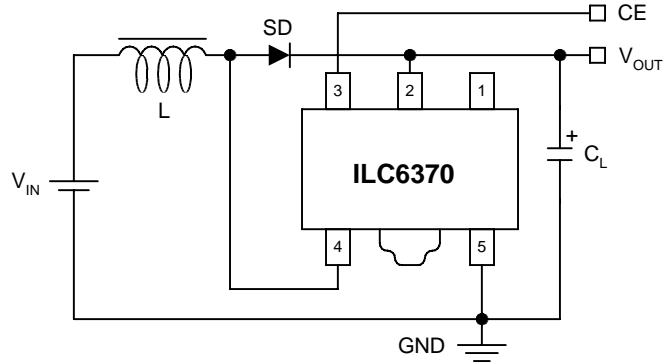

Figure 1: Test Circuit

- L: 100 μ H (SUMIDA, CD-54)
- SD: Diode (Schottky diode; MATSUSHITA MA735)
- C_L: 16V 47 μ F (Tantalum Capacitor; NICHICON, F93)

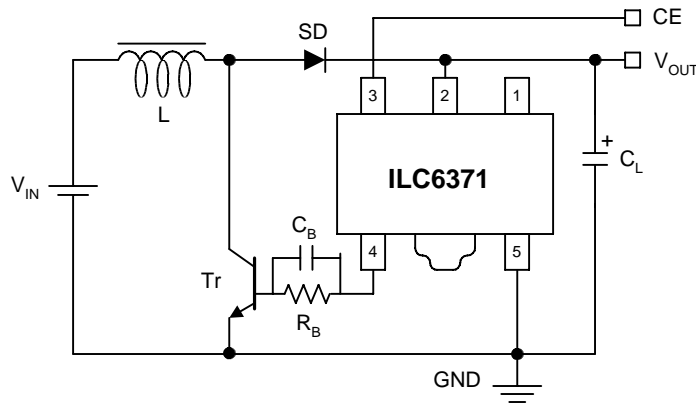

Figure 2: Test Circuit

- L: 100 μ H (SUMIDA, CD-54)
- SD: Diode (Schottky diode; MATSUSHITA MA735)
- C_L: 16V 47 μ F (Tantalum Capacitor; NICHICON, F93)
- R_B: 1k Ω
- C_B: 3300pF
- Tr: 2SC3279, 2SDI628G

Electrical Characteristics ILC6370BP-50

V_{OUT} = 5.0V, F_{OSC} = 100kHz, T_A = 25°C; Test Circuit of figure 1

Parameter	Symbol	Conditons	Min	Typ	Max	Units
Slow Start Time	T _{SS}			10		msec

Functions and Operation

The ILC6370 performs boost DC-DC conversion by controlling the switch element shown in the circuit below.

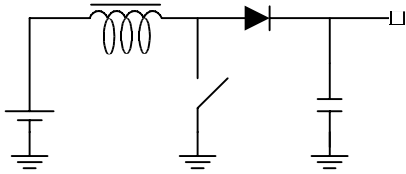

When the switch is closed, current is built up through the inductor. When the switch opens, this current has to go somewhere and is forced through the diode to the output. As this on and off switching continues, the output capacitor voltage builds up due to the charge it is storing from the inductor current. In this way, the output voltage gets boosted relative to the input. The ILC6370 monitors the voltage on the output capacitor to determine how much and how often to drive the switch.

In general, the switching characteristic is determined by the output voltage desired and the current required by the load. Specifically the energy transfer is determined by the power stored in the coil during each switching cycle.

$$PL = f(t_{ON}, V_{IN})$$

The ILC6370 and ILC6371 use a PWM or Pulse Width Modulation technique. The parts come in one of three fixed internal frequencies: 50, 100, or 180kHz. The switches are constantly driven at these frequencies. The control circuitry varies the power being delivered to the load by varying the on-time, or duty cycle, of the switch. Since more on-time translates to higher current build up in the inductor, the maximum duty cycle of the switch determines the maximum load current that the device can support. The ILC6370 and ILC6371 both support up to 87% duty cycles, for maximum usable range of load currents.

There are two key advantages of PWM type controllers. First, because the controller automatically varies the duty cycle of the switch's on-time in response to changing load conditions, the PWM controller will always have an optimized waveform for a steady-state load. This translates to very good efficiency at high currents and minimal ripple on the output. [Ripple is due to the output cap constantly accepting and storing the charge received from the inductor, and delivering charge as required by the load. The "pumping" action of the switch produces a sawtooth-shaped voltage as seen by the output.]

The other key advantage of the PWM type controllers is that the radiated noise due to the switching transients will always occur at the (fixed) switching frequency. Many applications do not care much about switching noise, but certain types of applications, especially communication equipment, need to minimize the high frequency interference within their system as much as is possible. Using a boost converter requires a certain amount of higher frequency noise to be generated; using a PWM converter makes that noise highly predictable; thus easier to filter out.

There are downsides of PWM approaches, especially at very low currents. Because the PWM technique relies on constant switching and varying duty cycle to match the load conditions, there is

some point where the load current gets to small to be handled efficiently. If the ILC6370 had an ideal switch, this would not be such a problem. But an actual switch consumes some finite amount of current to switch on and off; at very low current this can be of the same magnitude as the load current itself, driving switching efficiencies down to 50% and below.

The other limitation of PWM techniques is that, while the fundamental switching frequency is easier to filter out since it's constant, the higher order harmonics of PWM will be present and may have to be filtered out as well. Any filtering requirements will vary by application and by actual system design and layout, so generalizations in this area are difficult, at best. [For other boost converter techniques, please see the ILC6380/81 and ILC6390/91 data sheets.]

However, PWM control for boost DC-DC conversion is widely used, especially in audio-noise sensitive applications or applications requiring strict filtering of the high frequency components. Impala's products give very good efficiencies of 85% at 50mA output (5V operation), 87% maximum duty cycles for high load conditions, while maintaining very low shutdown current levels of 0.5µA. The only difference between the ILC6370 and ILC6371 parts is that the 6371 is configured to drive an external transistor as the switch element. Since larger transistors can be selected for this element, higher effective loads can be regulated.

Start-up Mode

The ILC6370 has an internal soft-start mode which suppresses ringing or overshoot on the output during start-up. The following diagram illustrates this start-up condition's typical performance

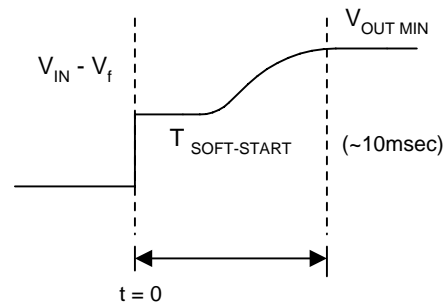

External Components and Layout Consideration

The ILC6370 is designed to provide a complete DC-DC converter solution with a minimum of external components. Ideally, only three externals are required: the inductor, a pass diode, and an output capacitor.

The inductor needs to be of low DC Resistance type, typically 1Ω value. Toroidal wound inductors have better field containment (less high frequency noise radiated out) but tend to be more expensive. Some manufacturers like Coilcraft have new bobbin-wound inductors with shielding included, which may be an ideal fit for these applications. Contact the manufacturer for more information.

The inductor size needs to be in the range of 47µH to 1mH. In general, larger inductor sizes deliver less current, so the load current will determine the inductor size used.

For load currents higher than 10mA, use an inductor from 47 μ H to 100 μ H. [The 100 μ H inductor shown in the data sheet is the most typical used for this application.]

For load currents of around 5mA, such as pagers, use an inductor in the range of 100 μ H to 330 μ H. 220 μ H is the most typical value used here.

For lighter loads, an inductor of up to 1mH can be used. The use of a larger inductor will increase overall conversion efficiency, due to the reduction in switching currents through the device.

For the ILC6371, using an external transistor, the use of a 47 μ H inductor is recommended based on our experience with the part. Note that these values are recommended for both 50kHz and 100kHz operation. If using the ILC6370 or ILC6371 at 180kHz, the inductor size can be reduced to approximately half of these stated values.

The capacitor should, in general, always be tantalum type, as tantalum has much better ESR and temperature stability than other capacitor types. NEVER use electrolytics or chemical caps, as the C-value changes below 0°C so much as to make the overall design unstable.

Different C-values will directly impact the ripple seen on the output at a given load current, due to the direct charge-to-voltage relationship of this element. Different C-Values will also indirectly affect system reliability, as the lifetime of the capacitor can be degraded by constant high current influx and outflux. Running a capacitor near its maximum rated voltage can deteriorate lifetime as well; this is especially true for tantalum caps which are particularly sensitive to overvoltage conditions.

In general, this capacitor should always be 47 μ F, Tantalum, 16V rating.

The diode must be of shottkey type for fast recovery and minimal loss. A diode rated at greater than 200mA and maximum voltage greater than 30V is recommended for the fastest switching time and best reliability over time. Different diodes may introduce different level of high frequency switching noise into the output waveform, so trying out several sources may make the most sense for your system.

For the ILC6371, much of the component selection is as described above, with the addition of the external NPN transistor and the base drive network. The transistor needs to be of NPN type, and should be rated for currents of 2A or more. [This translates to lower effective on resistance and, therefore, higher overall efficiencies.] The base components should remain at 1k Ω and 3300k Ω ; any changes need to be verified prior to implementation.

As for actual physical component layout, in general, the more compact the layout is, the better the overall performance will be. It is important to remember that everything in the circuit depends on a common and solid ground reference. Ground bounce can directly affect the output regulation and presents difficult behavior to predict. Keeping all ground traces wide will eliminate ground bounce problems.

It is also critical that the ground pin of C_L and V_{SS} pin of the device be the same pin on the board, as this capacitor serves two functions: that of the output load capacitor, and that of the input supply bypass capacitor.

Layouts for DC-DC converter designs are critical for overall performance, but following these simple guidelines can simplify the task by avoiding some of the more common mistakes made in these cases. Once actual performance is completed, be sure to double check the design on an actual manufacturing prototype product to verify that nothing has changed which can affect the performance.

Typical Performance Characteristics General conditions for all curves

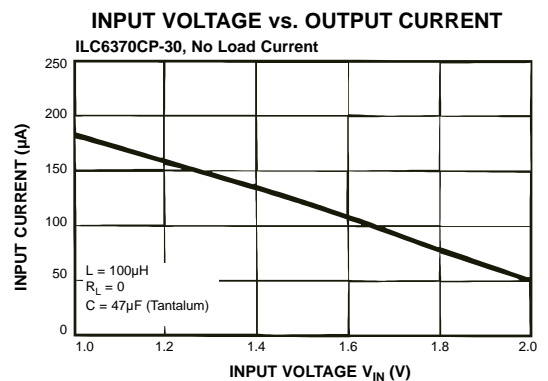
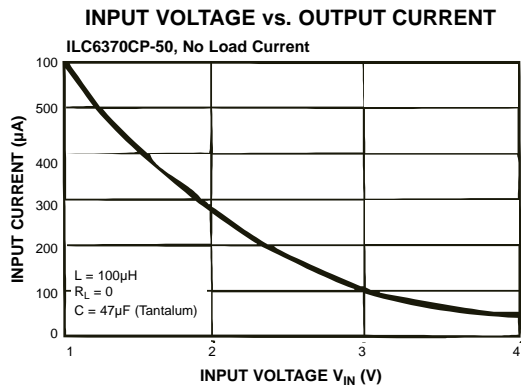
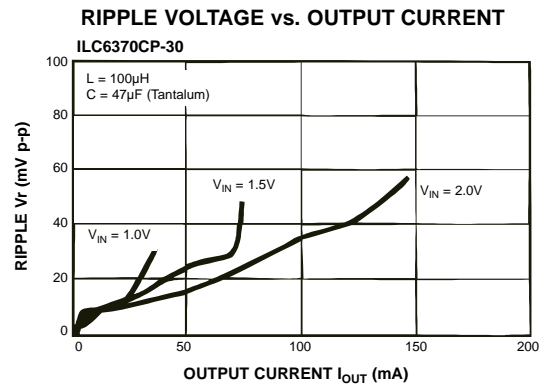
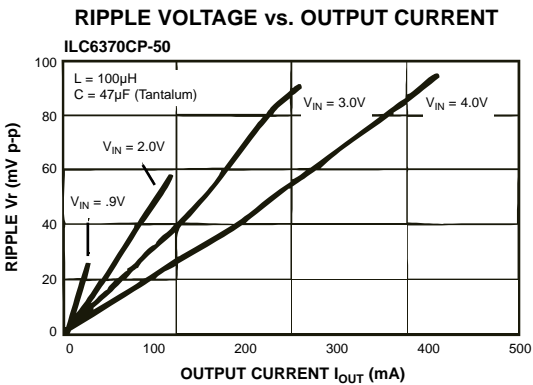
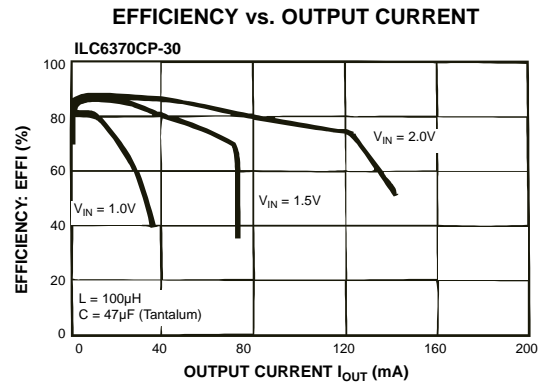
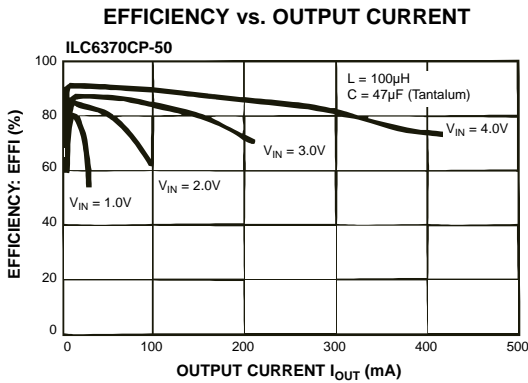
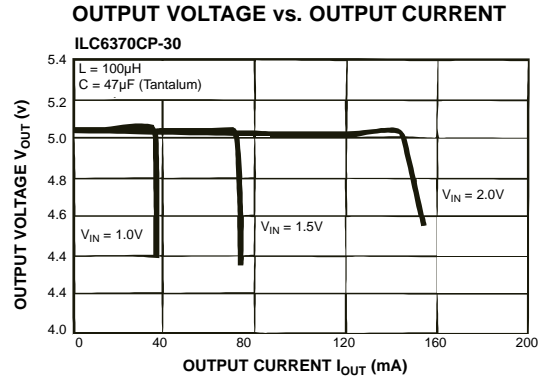
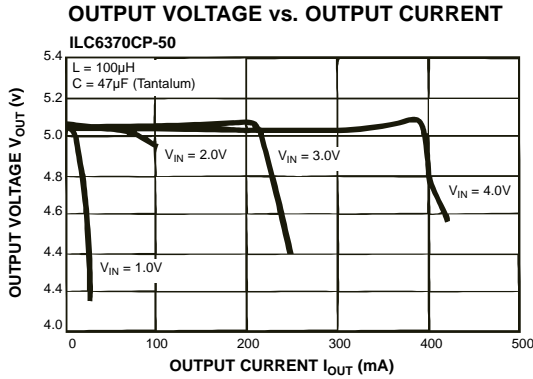

Typical Performance Characteristics General conditions for all curves

