

ILC6375

1 Amp SOT-89 Step Down PWM Switcher Controller



General Description

The ILC6375 is a high efficiency step-down DC-DC controller using a PWM control scheme. The typical efficiency can be as high as 85% to 90% at 10mA to 1 Amp load.

The ILC6375 drives an external switching transistor to deliver up to 1 Amp of output current. The internal oscillator operates at a fixed 100kHz frequency. Meanwhile, the device is capable of 100% duty cycle thus allowing true low drop-out operation to maximize battery life in portable applications. Output voltage is trimmed to $\pm 2.5\%$ accuracy.

The device includes internal phase compensation and soft-start circuitry. Available in a tiny SOT-89 package, the ILC6375 requires an external PNP switching transistor, an inductor, a shottky diode and capacitors.

Features

- ◆ Up to 1 Amp output current
- ◆ 85% to 90% efficiency at 0.5A to 1A ($V_{IN} = 7V, V_{OUT} = 5V$)
- ◆ 85% efficiency at 10mA ($V_{IN} = 7V, V_{OUT} = 5V$)
- ◆ 100% Duty Cycle for ultra low drop-out
- ◆ 100kHz $\pm 15\%$ internal oscillator
- ◆ 10V(max) input voltage
- ◆ $\pm 2.5\%$ precision output
- ◆ Tiny SOT-89 package

Applications

- ◆ Cellular Phones
- ◆ Palmtop PCs and PDAs
- ◆ Portable instrumentation
- ◆ Digital cameras
- ◆ High efficiency 5V to 3.3V converter

Block Diagram

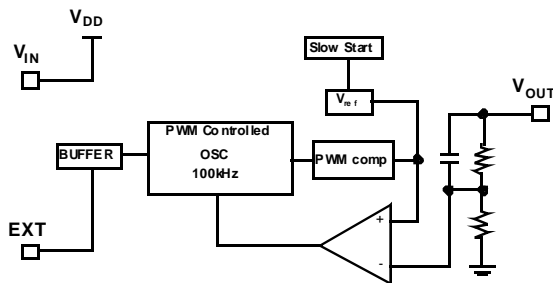

Ordering Information*

ILC6375CP-33	3.3V $\pm 2.5\%$ @100kHz external xtor
ILC6375CP-50	5.5V $\pm 2.5\%$ @100kHz external xtor

* Standard product offering comes in tape & reel, quantity 1000 per reel, orientation right for SOT-89

Typical Application

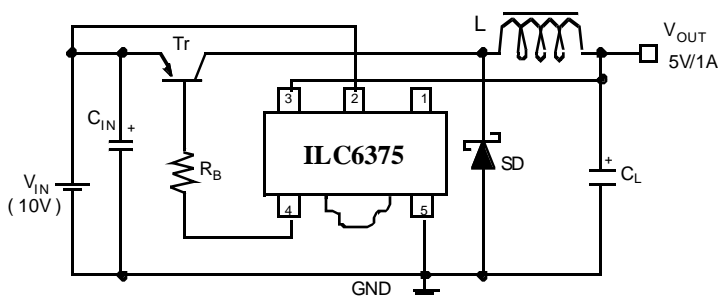

Pin Package Configuration

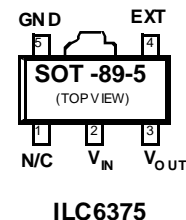

Absolute Maximum Ratings ($T_A = 25^\circ\text{C}$)

Parameter	Symbol	Ratings	Units
Input Voltage	V_{IN}	12	V
Voltage on V_{OUT} pin	V_{OUT}	12	V
Voltage on pin EXT	V_{EXT}	-0.3 to $V_{IN} + 0.3$	V
Current on pin EXT	I_{EXT}	+50	mA
Continuous Total Power Dissipation	P_D	500	mW
Operating Ambient Temperature	T_A	-30 to +80	$^\circ\text{C}$
Storage Temperatures	T_{STG}	-40 to +125	$^\circ\text{C}$

Electrical Characteristics ILC6375CP-50

$V_{OUT} = 5.0\text{V}$ $F_{OSC} = 100\text{kHz}$ $T_A = 25^\circ\text{C}$, unless otherwise specified, $V_{IN} = 6\text{V}$, $I_{OUT} = 100\text{mA}$, See test circuit, figure 1.

Parameter	Symbol	Conditions	Min	Typ	Max	Units
Output Voltage	V_{OUT}		4.875	5.000	5.125	V
Input Voltage	V_{IN}				10	V
Supply Current 1	I_{DD1}	4.75V applied to V_{OUT} with no external components		25	42	μA
Supply Current 2	I_{DD2}	5.5V applied to V_{OUT} with no external components		20	34	μA
EXT "High" ON Resistance	R_{EXTH}	5.5V applied to V_{OUT} with no external components, $V_{EXT} = 4.6\text{V}$		38	63	Ω
EXT "Low" ON Resistance	R_{EXTL}	4.75V applied to V_{OUT} with no external components, $V_{EXT} = 0.4\text{V}$		30	50	Ω
Oscillator Frequency	F_{OSC}	Measure Frequency at EXT pin	85	100	115	kHz
Maximum Duty Ratio	MAXDTY	Measure Duty Cycle at EXT pin	100			%
Efficiency	EFFI			90		%
Soft-Start Time	T_{SS}			10		ms

Electrical Characteristics ILC6375CP-33

$V_{OUT} = 3.3V$ $F_{OSC} = 100kHz$ $T_A = 25^{\circ}C$, unless otherwise specified, $V_{IN} = 4V$, $I_{OUT} = 55mA$, See test circuit, figure 1.

Parameter	Symbol	Conditions	Min	Typ	Max	Units
Output Voltage	V_{OUT}		3.218	3.300	3.383	V
Input Voltage	V_{IN}				10	V
Supply Current 1	I_{DD1}	3V applied to V_{OUT} with no external components		20	33	μA
Supply Current 2	I_{DD2}	3.6V applied to V_{OUT} with no external components		16	27	μA
EXT "High" ON Resistance	R_{EXTH}	3.6V applied to V_{OUT} with no external components, $V_{EXT} = 3.6V$		57	95	Ω
EXT "Low" ON Resistance	R_{EXTL}	3V applied to V_{OUT} with no external components, $V_{EXT} = 0.4V$		46	76	Ω
Oscillator Frequency	F_{OSC}	Measure Frequency at EXT pin	85	100	115	kHz
Maximum Duty Ratio	MAXDTY	Measure Duty Cycle at EXT pin	100			%
Efficiency	EFFI			90		%
Soft Start Time	T_{SS}			10		ms

Applications Circuits

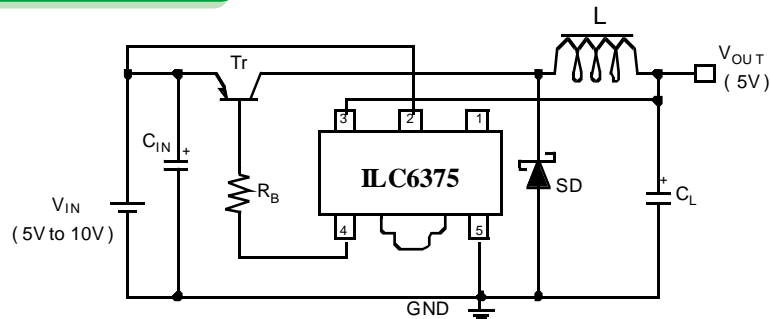

Figure 1: ILC6375 Typical Application

- L: 100mH (SUMIDA CD-54)
- SD: Shottkey Diode (MATSUSHITA MA735)
- C_{IN} : 10mF/16V Tantalum Capacitor (NICHICON F93)
- C_L : 47mF/10V Tantalum Capacitor (NICHICON F93)
- Tr: PNP Transistor (TOSHIBA 2SA1213)
- R_B : 1k Ω

Electrical Characteristics ILC6375CP-33

$L = 100\text{kHz}$ $C_L = 47\mu\text{F}3.3\text{V}$ $F_{\text{OSC}} T_A = 25^\circ\text{C}$, unless otherwise specified, $V_{\text{IN}} = 4\text{V}$, $I_{\text{OUT}} = 55\text{mA}$, See test circuit, figure 1.

Output Voltage vs Output Current

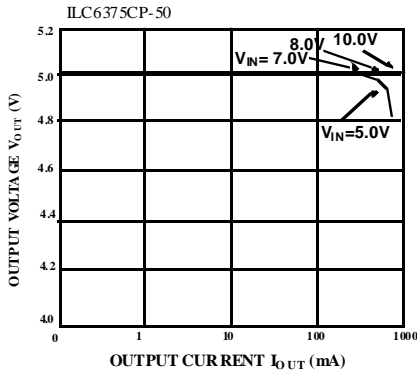

Output Voltage vs Output Current

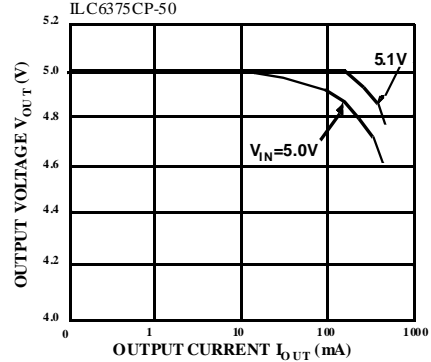

Efficiency vs Output Current

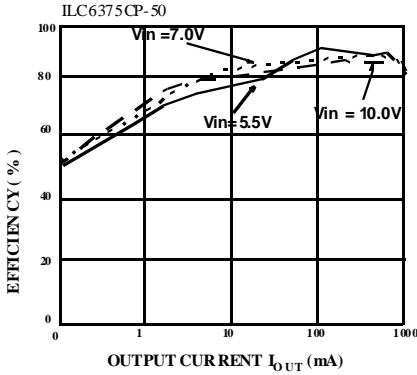

Output Ripple Voltage vs Output Current

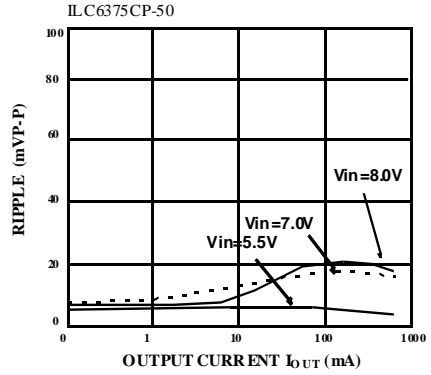

Efficiency vs Output Current

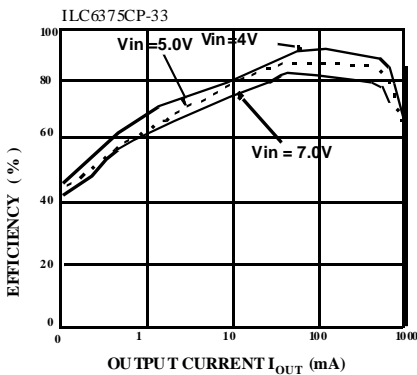

Output Ripple Voltage vs Output Current

