

# I LC6390/91

## SOT-89 Step-Up PFM Switcher with Auto-Load Sense

### Features

- 85% conversion efficiency at 50mA out
- Start-up voltages as low as 900mV
- $\pm 2.5\%$  accurate outputs
- Complete switch design with only 3 external components
- Automatically senses load variations to select the optimal duty cycle and extend conversion efficiency over a wide range
- External transistor configuration to run as switcher controller
- Shutdown to 0.5 $\mu$ A

### Applications

- Cellular phones, pagers
- Cameras, video recorders
- Palmtops and PDAs

### Description

50 mA boost converter using Pulse Frequency Modulation, or PFM, technique, in 5-lead SOT-89 or a 5-lead SOT-23 package. Only 3 external components are needed to complete the switcher design.

The ILC6390 automatically senses load variations to choose between 55% and 75% duty cycles. Normal operation is 55% duty at 155kHz; when load currents exceed the internal comparator trip point, a “turbo mode” kicks in to provide extended on-time switching (75% duty at 100kHz oscillation).

Requiring only 30 $\mu$ A of supply current, the ILC6390 achieves efficiencies as high as 85% at 5V yet shuts down to 0.5 $\mu$ A max.

Standard voltages offered are 2.5, 3.3, and 5.0V and is available in both a 5 lead SOT-23 and 5 lead SOT-89 package for small footprint applications.

In addition, the ILC6391 is configured to drive an external transistor to achieve higher power levels.

### Typical Applications

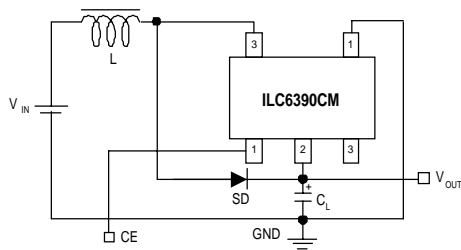

**Figures 1 & 2**

L: 100 $\mu$ H (SUMIDA, CD-54)

SD: Diode (Schottky diode; MATSUSHITA MA 735)

CL: 16V 47 $\mu$ F (Tantalum Capacitor; NICHICON, f93)

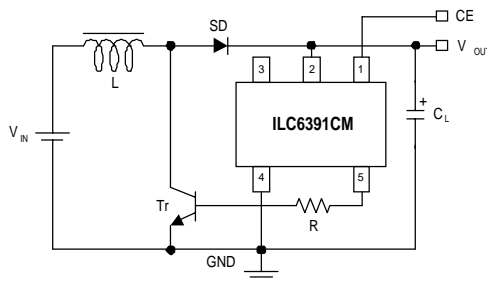
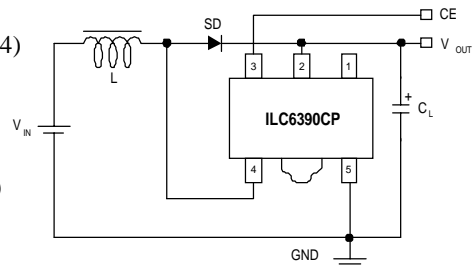

**Figures 3 & 4**

L: 47 $\mu$ H (SUMIDA, CD-54)

SD: Diode (Schottky diode; MATSUSHITA MA735)

CL: 16V 47 $\mu$ F (Tantalum Capacitor; NICHICON, F93)

RB: 1k $\Omega$

CB: 3300pF

Tr: 2SC3279, 2SD1628G

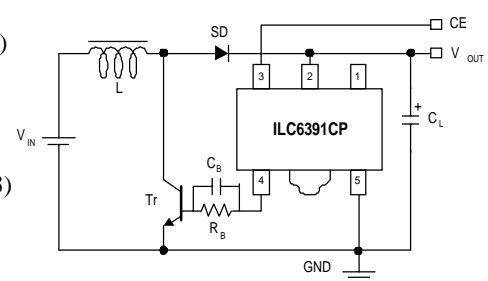

## Pin Assignments

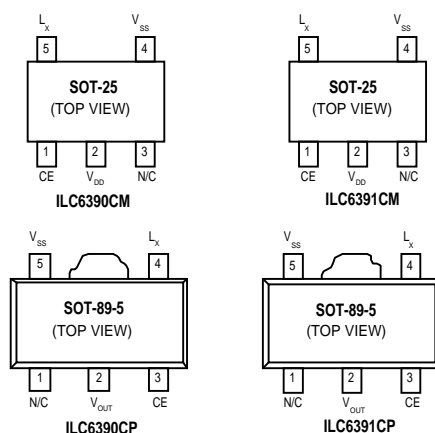

## Internal Block Diagram

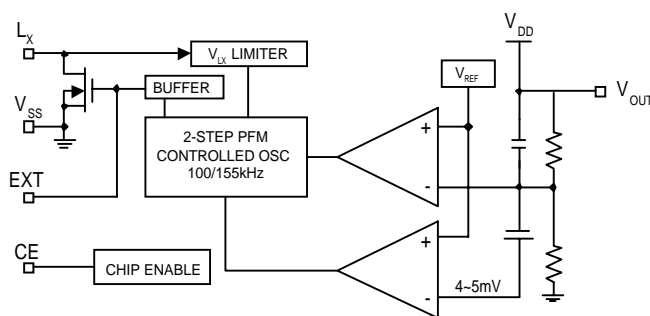

## Absolute Maximum Ratings ( $T_A = 25^\circ\text{C}$ )

Parameter	Symbol	Ratings	Units
$V_{OUT}$ Input Voltage	$V_{OUT}$	12	V
Voltage on pin $L_X$	$V_{LX}$	12	V
Current on pin $L_X$	$I_{LX}$	400	mA
Voltage on pin EXT	$V_{EXT}$	$V_{SS}-0.3 \sim V_{OUT}+0.3$	V
Current on pin EXT	$I_{EXT}$	$\pm 50$	mA
CE Input Voltage	$V_{CE}$	12	V
$V_{DD}$ Input Voltage	$V_{DD}$	12	V
Continuous Total Power Dissipation	$P_D$ (SOT-25) $P_D$ (SOT-89)	150 500	mW
Operating Ambient Temperature	$T_{opr}$	-30~+80	$^\circ\text{C}$
Storage Temperature	$T_{stg}$	-40~+125	$^\circ\text{C}$

## Electrical Characteristics ILC6390

$V_{OUT} = 5.0V$   $T_A = 25^\circ C$ . Unless otherwise specified,  $V_{IN} = V_{OUT} \times 0.6$ ,  $I_{OUT} = 50mA$ . See schematic, fig. 1 & 2.

Parameter	Symbol	Conditions	Min.	Typ.	Max.	Units
Output Voltage	$V_{OUT}$	Test Circuit Figures 1 & 2	4.875	5.000	5.125	V
Input Voltage	$V_{IN}$				10	V
Oscillation Startup Voltage	$V_{ST}$	$I_{OUT} = 1mA$		0.80	0.9	V
Oscillation Hold Voltage	$V_{HLD}$	$I_{OUT} = 1mA$	0.70			V
NO-Load Input Current	$I_{IN}$	$I_{OUT} = 0mA$ (Note1)		5.3	10.6	$\mu A$
Supply Current 1 (Note 2)	$I_{DD1}$	$V_{OUT} = 4.75V$		31.7	63.4	$\mu A$
Supply Current 2		$V_{OUT} = 5.5V$		2.4	4.8	$\mu A$
$L_X$ Switch-On Resistance	$R_{SWON}$	$V_{OUT} = 4.75V$ , $V_{LX} = 0.4$		2.8	4.3	$\Omega$
$L_X$ Leakage Current	$I_{LXL}$	No external components, $V_{OUT} = V_{LX}$ $= 10V$			1.0	$\mu A$
Duty Ratio 1	DUTY 1	$V_{OUT} = 4.75V$ , Measuring of $L_X$ waveform	70	75	80	%
Duty Ratio 2	DUTY 2	$V_{OUT} = 4.75V$ , Measuring of $L_X$ on- time	50	55	60	%
Maximum Oscillation Freq. 1	MFO 1	$V_{OUT} = 4.75V$ , 75% duty	85	100	115	kHz
Maximum Oscillation Freq. 2	MFO 2	$V_{OUT} = 4.75V$ , 55% duty	153	180	207	kHz
Stand = by Current	$I_{STB}$	$V_{OUT} = 4.75V$			0.5	$\mu A$
CE "High" Voltage	$V_{CEH}$	$V_{OUT} = 4.75V$ , Existence of $L_X$ Oscillation	0.75			V
CE "Low" Voltage	$V_{CEL}$	$V_{OUT} = 4.75V$ , Disappearance of $L_X$ Oscillation			0.20	V
CE "High" Current	$I_{CEH}$	$V_{CE} = V_{OUT} \times 0.95$			0.25	$\mu A$
CE "Low" Current	$I_{CEL}$	$V_{OUT} = 4.75V$ , $V_{CE} = 0V$			-0.25	$\mu A$
$L_X$ Limit Voltage	$V_{LXLMT}$	$V_{OUT} = 4.75V$ , $f_{OSC} > MFO \times 2$ (Note 3)	0.7		1.1	V
Efficiency	EFFI	Test Circuit Figures 1 & 2		85		%

Note:

1. The Schottky diode (S.D.), in figure 3 must be type MA735, with Reverse current ( $I_R$ )  $< 1.0\mu A$  at reverse voltage ( $V_R$ )=10.0V
2. "Supply Current 1" is the supply current while the oscillator is continuously oscillating. In actual operation the oscillator periodically operates which results in less average power consumption. The current that is actually provided by external  $V_{IN}$  source is represented by "No-Load Input Current."
3. The switching frequency is determined by the delay time of the internal comparator and MFO1, which sets the min. on-time

## Electrical Characteristics ILC6390

$V_{OUT} = 5.0V$   $T_A = 25^\circ C$ . Unless otherwise specified,  $V_{IN} = V_{OUT} \times 0.6$ ,  $I_{OUT} = 50mA$ . See schematic, fig. 3 & 4.

Parameter	Symbol	Conditions	Min.	Typ.	Max.	Units.
Output Voltage	$V_{OUT}$	Test Circuit Figures 3 & 4	4.875	5.000	5.125	V
Input Voltage	$V_{IN}$				10	V
Operation Startup Voltage	$V_{ST}$	$I_{OUT} = 1mA$		0.80	0.9	V
Operation Hold Voltage	$V_{ST}$	$I_{OUT} = 1mA$	0.70			V
Supply Current 1 (Note 1)	$I_{DD} 1$	$V_{OUT} = 4.75V$		31.7	63.4	$\mu A$
Supply Current 2	$I_{DD} 2$	$V_{OUT} = 5.5V$		2.4	4.8	$\mu A$
EXT "High" On-Resistance	$R_{EXTH}$	$V_{OUT} = 4.75V$ , $V_{EXT} = V_{OUT} - 0.4$		50	75	$\Omega$
EXT "Low" On-Resistance	$R_{EXTL}$	$V_{OUT} = 4.75V$ , $V_{EXT} = 0.4$		50	75	$\Omega$
Duty Ratio 1	DUTY 1	$V_{OUT} = 4.75V$ , Measuring of EXT waveform	70	75	80	%
Duty Ratio	DUTY 2	$V_{IN} = V_{OUT} \times 0.95$ , $I_{OUT} = 1mA$ , Measuring of EXT High State	50	55	60	%
Maximum Oscillation Freq. 1	MFO 1	$V_{OUT} = 4.75V$ , 75% duty	85	100	115	kHz
Maximum Oscillation Freq. 2	MFO 2	$V_{IN} = V_{OUT} \times 0.95$ , 55% duty	153	180	207	kHz
Stand = by Current	$I_{STB}$	$V_{OUT} = 4.75V$			0.5	$\mu A$
CE "High" Voltage	$V_{CEH}$	$V_{OUT} = 4.75V$ , Existence of EXT Oscillation	0.75			V
CE "Low" Voltage	$I_{CEL}$	$V_{OUT} = 4.75V$ , Disappearance of EXT Oscillation			0.20	V
CE "High" Current	$I_{CEH}$	$V_{CE} = V_{OUT} = 4.75V$			0.25	$\mu A$
CE "Low" Current		$V_{OUT} = 4.75$ , $V_{CE} = 0V$			-0.25	$\mu A$
Efficiency	EFFI	Test Circuit Figures 3 & 4		85		%

### Note:

1. "Supply Current 1" is the supply current while the oscillator is continuously oscillating. In actual operation the oscillator periodically operates which results in less average power consumption.

The ILC6390 performs boost DC-DC conversion by controlling the switch element shown in the circuit below.

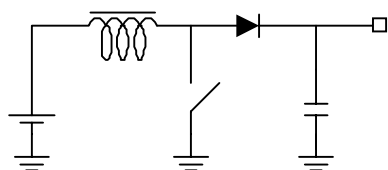

When the switch is closed, current is built up through the inductor. When the switch opens, this current has to go somewhere and is forced through the diode to the output. As this on and off switching continues, the output capacitor voltage builds up due to the charge it is storing from the inductor current. In this way, the output voltage gets boosted relative to the input. The ILC6390 monitors the voltage on the output capacitor to determine how much and how often to drive the switch.

In general, the switching characteristic is determined by the output voltage desired and the current required by the load. Specifically the energy transfer is determined by the power stored in the coil during each switching cycle.

$$P_L = f(t_{ON}, V_{IN})$$

The ILC6390 and ILC6391 use a PFM or Pulse Frequency Modulation technique. In this technique, the switch is always turned on for a fixed period of time, corresponding to a fixed switching frequency at a predefined duty cycle. For the ILC6390 this value is 3.55msec on time, corresponding to 55% duty cycle at 155kHz. Because the inductor value, capacitor size, and switch on-time and frequency are all fixed, the ILC6390 in essence delivers the same amount of power to the output during each switching cycle. This in turn creates a constant output voltage ramp which is dependent on the output load requirement. In this mode, the only difference between the PFM and PWM techniques is the duty cycle of the switch.

Once the output voltage reaches the set point, the ILC6390 will shut off the switch oscillator and wait until the output voltage drops low again, at which point it will re-start the oscillator. As you can see in the diagram, the PFM boost converter actually skips pulses as a way of varying the amount of power being delivered to the output.

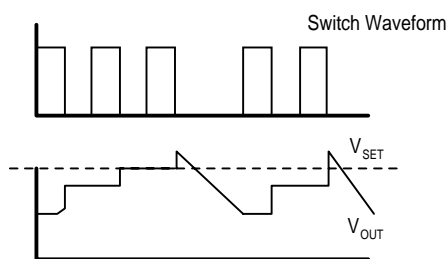

Because of this, PFM is sometimes called “Pulse Skipping Modulation.”

The chief advantage of using a PFM technique is that, at low currents, the switcher is able to maintain regulation without constantly driving a switch on and off. This power savings can be 5mA or more for the ILC6390 versus the ILC6370, and at very light loads this current difference can make a noticeable impact on overall efficiency.

However, because the ILC6390 will skip pulses based on load current, the effective frequency of switching may well drop into the audio band. This means that the radiated noise of the ILC6390 may interfere with the audio channel of the system and additional filtering may be necessary. In addition, because the PFM on-time is fixed, it usually has higher output ripple voltage than the PWM switcher, which dynamically changes the on-time to match the load current requirements. *[Ripple is due to the output cap constantly accepting and storing the charge received from the inductor, and delivering charge as required by the load. The “pumping” action of the switch produces a sawtooth-shaped voltage as seen by the output.]*

On the plus side, because pulses are skipped, overtone content of the frequency noise is lower than in a PWM configuration. The sum of these characteristics for PFM converters makes it the ideal choice for low-current or ultra-long run-time applications, where overall conversion efficiency at low currents is of primary concern. *[For other conversion techniques, please see the ILC6370/71 and ILC6380/81 datasheets.]*

## Dual-Step Mode

The ILC6390 and ILC6391 have one other unique feature, that being to automatically switch to a second switching scheme in the presence of heavy output loading. As we mentioned, the standard switching scheme for these parts is a 3.55msec, 155kHz, 55% duty cycle part. However, if the device detects that the output load increases beyond a set point (as seen by the voltage drop on the output capacitor), it switches in a 7.5msec, 100kHz, 75% duty cycle “turbo mode” specifically to keep up with the increased load demand. This switchover is seamless to the user, but will result in a change in the output ripple voltage characteristic of the DC-DC converter.

PFM converters are widely used in portable consumer applications not requiring a high current level and relatively unaffected by audio noise. Applications such as pagers and PDAs, which need to operate in stand-by for extended periods of time, gravitate toward the advantages of PFM since maximum run-time is a chief differentiating element. The ILC6390 addresses this low-current requirement, and additionally offers a “turbo” mode which maintains output regulation in the presence of heavier-than-normal load currents, and maintains 0.5mA shutdown currents.

The only difference between the ILC6390 and ILC6391 parts is that the 6391 is configured to drive an external transistor as the switch element. Since larger transistors can be selected for this element, higher effective loads can be regulated.

## External Components and Layout Consideration

The ILC6390 is designed to provide a complete DC-DC converter solution with a minimum of external components. Ideally, only three externals are required: the inductor, a pass diode, and an output capacitor.

The inductor needs to be of low DC Resistance type, typically  $1\ \Omega$  value. Toroidal wound inductors have better field containment (less high frequency noise radiated out) but tend to be more expensive. Some manufacturers like Coilcraft have new bobbin-wound inductors with shielding included, which may be an ideal fit for these applications. Contact the manufacturer for more information.

The inductor size needs to be in the range of 47mH to 1mH. In general, larger inductor sizes deliver less current, so the load current will determine the inductor size used.

For load currents higher than 10mA, use an inductor from 47mH to 100mH. *[The 100mH inductor shown in the datasheet is the most typical used for this application.]*

For load currents of around 5mA, such as pagers, use an inductor in the range of 100mH to 330mH. 220mH is the most typical value used here.

For lighter loads, an inductor of up to 1mH can be used. The use of a larger inductor will increase overall conversion efficiency, due to the reduction in switching currents through the device.

For the ILC6391, using an external transistor, the use of a 47mH inductor is recommended based on our experience with the part.

The capacitor should, in general, always be tantalum type, as tantalum has much better ESR and temperature stability than other capacitor types. NEVER use electrolytics or chemical caps, as the C-value changes below  $0^\circ\text{C}$  so much as to make the overall design unstable.

Different C-values will directly impact the ripple seen on the output at a given load current, due to the direct charge-to-voltage relationship of this element. Different C-values will also indirectly affect system reliability, as the lifetime of the capacitor can be degraded by constant high current influx and outflux. Running a capacitor near its maximum rated voltage can deteriorate lifetime as well; this is especially true for tantalum caps which are particularly sensitive to over-voltage conditions.

In general, then, this capacitor should always be 47mF, Tantalum, 16V rating.

The diode must be of shottkey type for fast recovery and minimal loss. A diode rated at greater than 200mA and maximum voltage greater than 30V is recommended for the fastest switching time and best reliability over time. Different diodes may introduce different levels of high frequency switching noise into the output waveform, so trying out several sources may make the most sense for your system.

For the ILC6391, much of the component selection is as described above, with the addition of the external NPN transistor and the base drive network. The transistor needs to be of NPN type, and should be rated for currents of 2A or more. *[This translates to lower effective on resistance and, therefore, higher overall efficiencies.]* The base components should remain at  $1\text{k}\Omega$  and 3300pF; any changes need to be verified prior to implementation.

As for actual physical component layout, in general, the more compact the layout is, the better the overall performance will be. It is important to remember that everything in the circuit depends on a common and solid ground reference. Ground bounce can directly affect the output regulation and presents difficult behavior to predict. Keeping all ground traces wide will eliminate ground bounce problems.

It is also critical that the ground pin of  $C_L$  and the  $V_{SS}$  pin of the device be the same point on the board, as this capacitor serves two functions: that of the output load capacitor, and that of the input supply bypass capacitor.

Layouts for DC-DC converter designs are critical for overall performance, but following these simple guidelines can simplify the task by avoiding some of the more common mistakes made in these cases. Once actual performance is completed, though, be sure to double-check the design on actual manufacturing prototype product to verify that nothing has changed which can affect the performance.

# Typical Performance Characteristics General conditions for all curves

**Output Voltage vs Output Current**

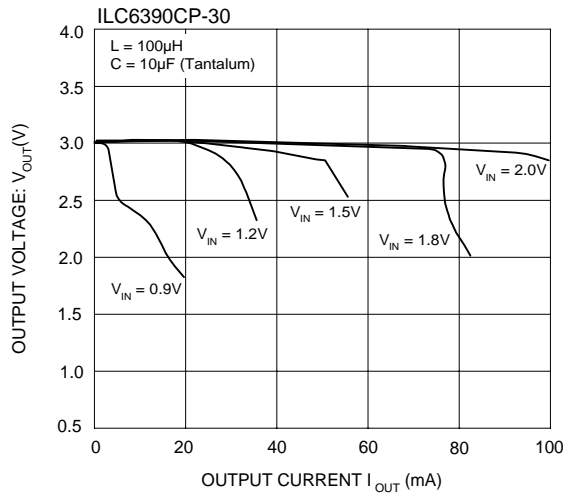

**Efficiency vs. Output Current**

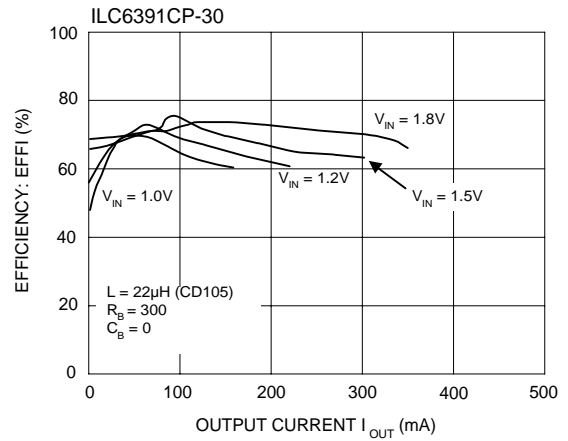

**Efficiency vs. Output Current**

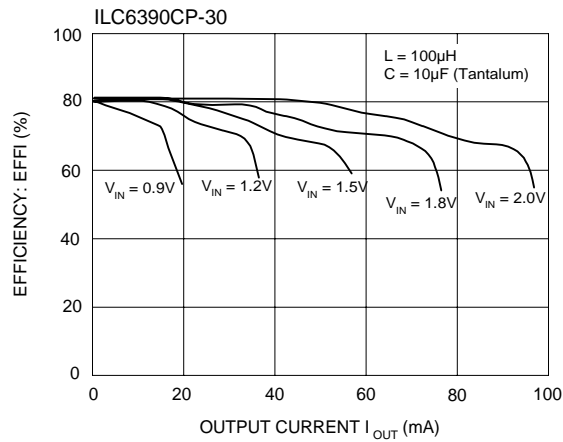

**Output Voltage vs. Output Current**

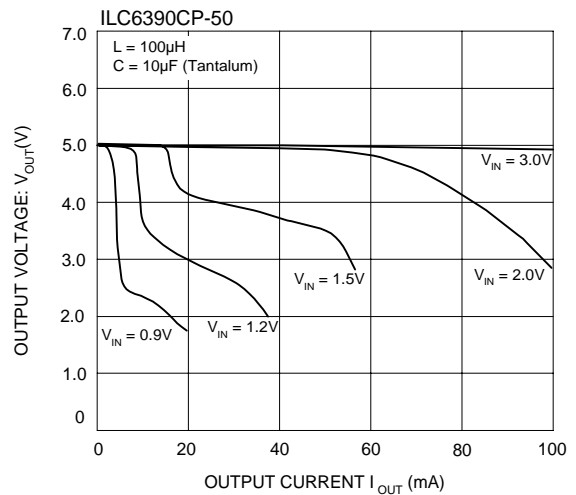

**Ripple Voltage vs. Output Current**

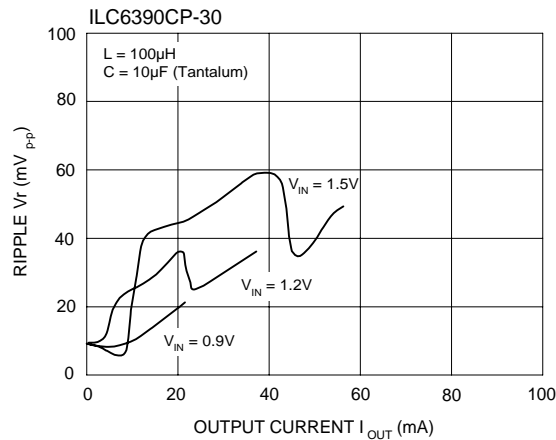

**Efficiency vs. Output Current**

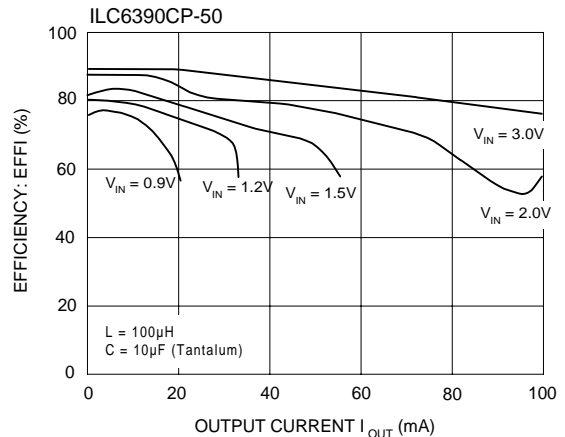

# Typical Performance Characteristics General conditions for all curves

**Ripple Voltage vs. Output Current**

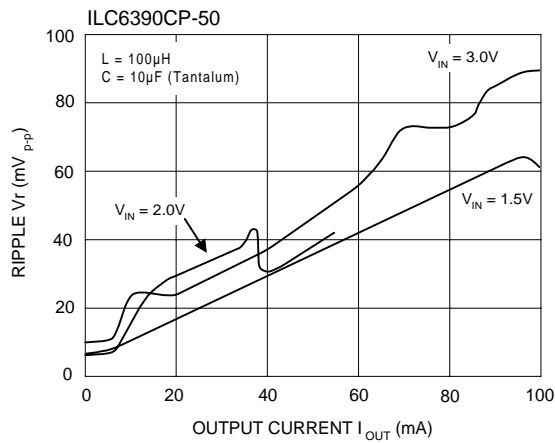

**Output Voltage vs. Output Current**

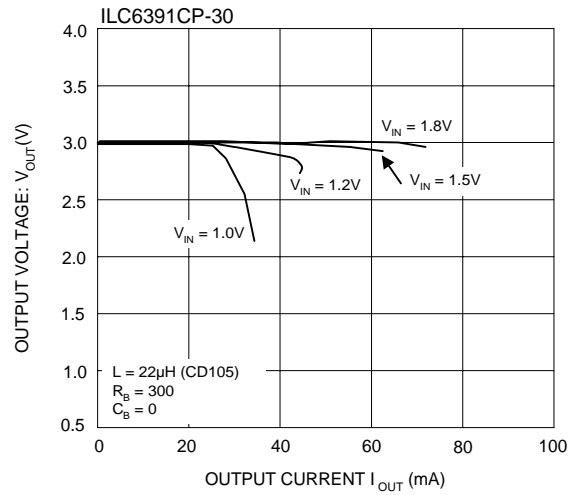

**Efficiency vs. Output Current**

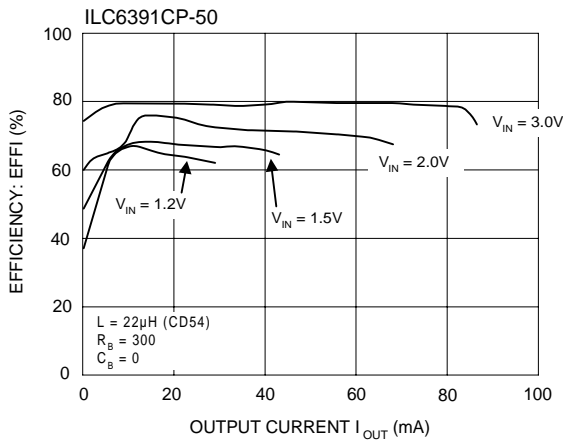

**Output Voltage vs. Output Current**

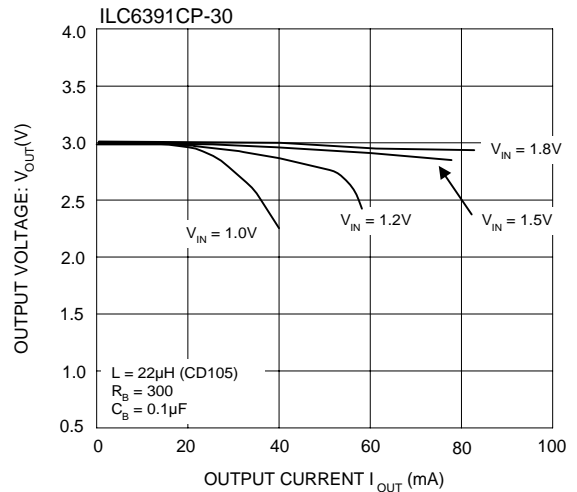

**Efficiency vs. Output Current**

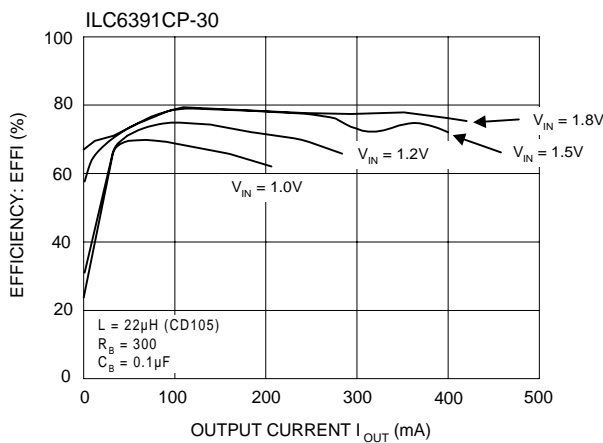

**Ripple Voltage vs. Output Current**

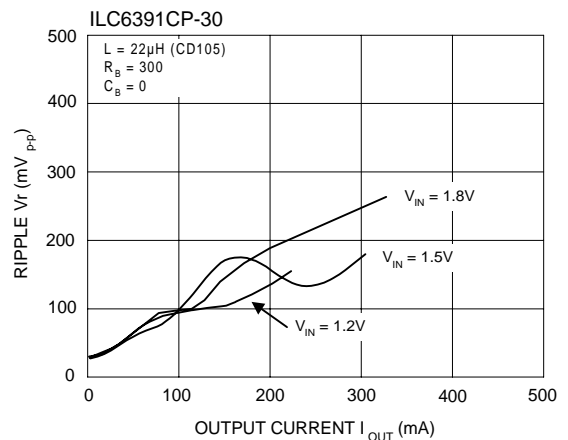



# Typical Performance Characteristics General conditions for all curves

**Efficiency vs. Output Current**

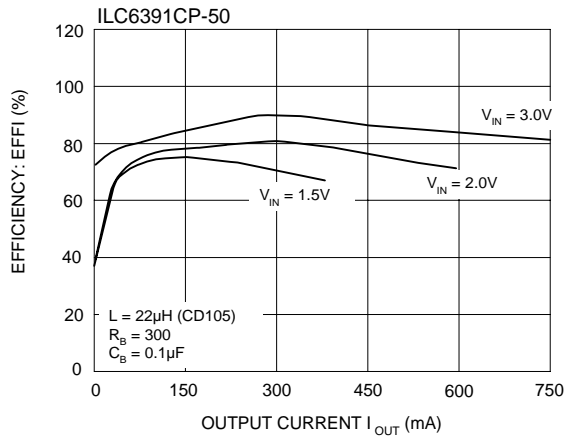

**Ripple Voltage vs. Output Current**

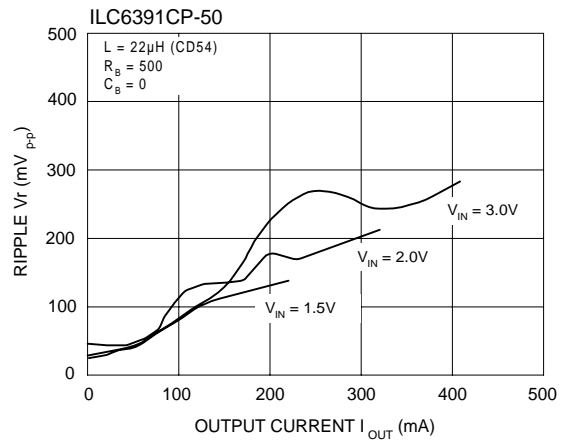

**Output Voltage vs. Output Current**

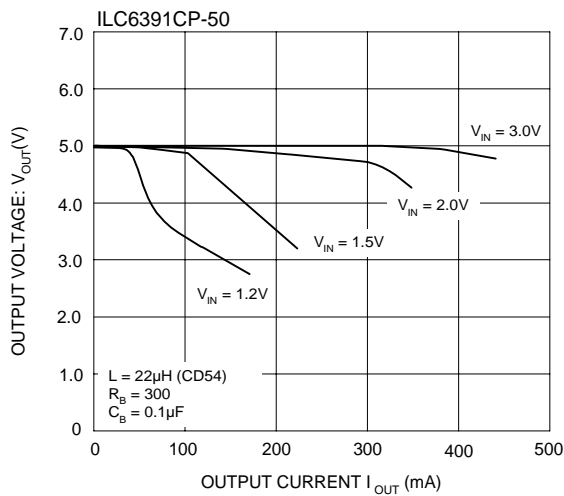

**Ripple Voltage vs. Output Current**

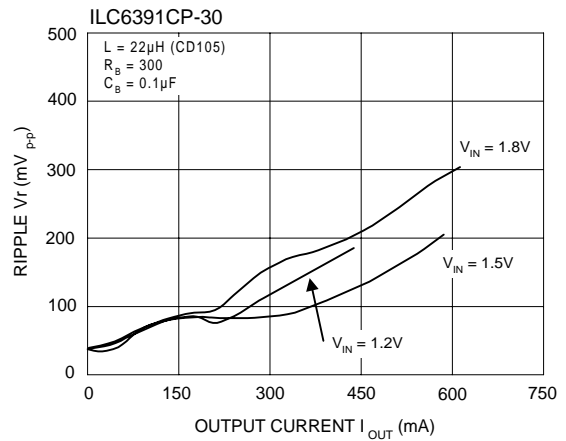

**Output Voltage vs. Output Current**

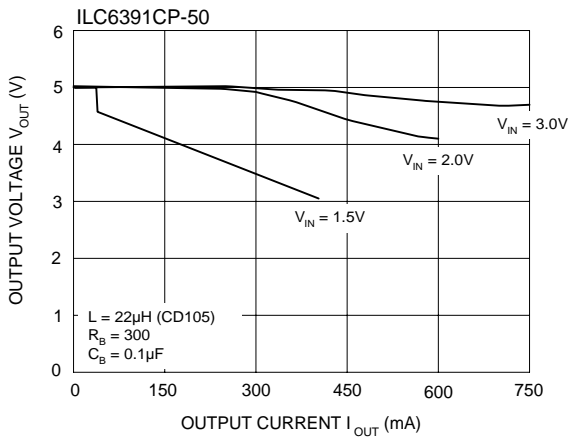

**Ripple Voltage vs. Output Current**

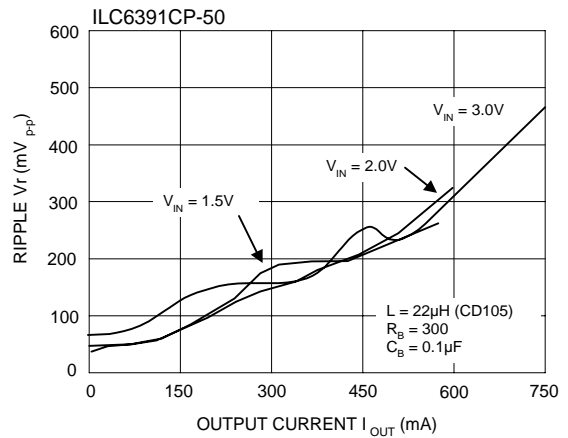

**DISCLAIMER**

FAIRCHILD SEMICONDUCTOR RESERVES THE RIGHT TO MAKE CHANGES WITHOUT FURTHER NOTICE TO ANY PRODUCTS HEREIN TO IMPROVE RELIABILITY, FUNCTION OR DESIGN. FAIRCHILD DOES NOT ASSUME ANY LIABILITY ARISING OUT OF THE APPLICATION OR USE OF ANY PRODUCT OR CIRCUIT DESCRIBED HEREIN; NEITHER DOES IT CONVEY ANY LICENSE UNDER ITS PATENT RIGHTS, NOR THE RIGHTS OF OTHERS.

**LIFE SUPPORT POLICY**

FAIRCHILD'S PRODUCTS ARE NOT AUTHORIZED FOR USE AS CRITICAL COMPONENTS IN LIFE SUPPORT DEVICES OR SYSTEMS WITHOUT THE EXPRESS WRITTEN APPROVAL OF THE PRESIDENT OF FAIRCHILD SEMICONDUCTOR CORPORATION. As used herein:

1. Life support devices or systems are devices or systems which, (a) are intended for surgical implant into the body, or (b) support or sustain life, and (c) whose failure to perform when properly used in accordance with instructions for use provided in the labeling, can be reasonably expected to result in a significant injury of the user.
2. A critical component in any component of a life support device or system whose failure to perform can be reasonably expected to cause the failure of the life support device or system, or to affect its safety or effectiveness.