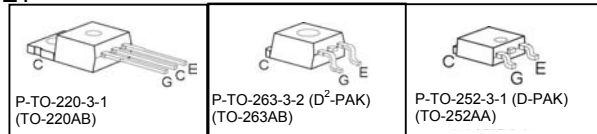
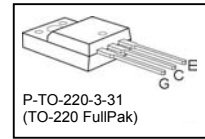
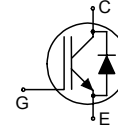




# ILA03N60, ILP03N60 ILB03N60, ILD03N60

## LightMOS Power Transistor

- New high voltage technology designed for ZVS-switching in lamp ballasts
- IGBT with integrated reverse diode
- 4A current rating for reverse diode
- Up to 10 times lower gate capacitance than MOSFET
- Avalanche rated
- 150°C operating temperature
- FullPak isolates 2.5 kV AC (1 min.)



Type	$V_{CE}$	$I_C$	$V_{CE(sat), T_j=25^\circ C}$	$T_{j,max}$	Package	Ordering Code
ILA03N60	600V	3.0A	2.9V	150°C	P-TO-220-3-31	Q67040-S4626
ILP03N60	600V	3.0A	2.9V	150°C	P-TO-220-3-1	Q67040-S4628
ILB03N60	600V	3.0A	2.9V	150°C	P-TO-263-3-2	Q67040-S4627
ILD03N60	600V	3.0A	2.9V	150°C	P-TO-252-3-1	Q67040-S4625

### Maximum Ratings

Parameter	Symbol	Value		Unit	
		ILA03N60	Others		
Collector-emitter voltage	$V_{CE}$	600		V	
DC collector current	$I_C$	$T_C = 25^\circ C$	3	4.5	A
		$T_C = 100^\circ C$	2.2	3	
Pulsed collector current, $t_p$ limited by $T_{j,max}$ , $t_p < 10$ ms	$I_{C,puls}$	9			
Pulsed collector current, $t_p$ limited by $T_{j,max}$		5.5			
Diode forward current	$I_F$	$T_C = 25^\circ C$	4	4	
		$T_C = 100^\circ C$	2.2	2.5	
Diode pulsed current, $t_p$ limited by $T_{j,max}$ , $t_p < 10$ ms	$I_{F,puls}$	9			
Diode pulsed current, $t_p$ limited by $T_{j,max}$		5.5			
Avalanche energy, single pulse $I_C=0.4A$ , $V_{CE}=50V$	$E_{AS}$	0.32		mJ	
Gate-emitter voltage	$V_{GE}$	$\pm 30$		V	
Reverse diode dv/dt $I_C \leq 3A$ , $V_{CE} \leq 450V$ , $T_{j,max} \leq 150^\circ C$	dv/dt	1 <sup>1</sup>		V/ns	
Power dissipation ( $T_C = 25^\circ C$ )	$P_{tot}$	16.5	27	W	
Operating junction and storage temperature	$T_{stg}$	-55...+150		°C	
Soldering temperature for 10 s (according to JEDEC J-STA-020A)	$T_s$	D-Pak	255		
		Others	220		

<sup>1</sup> Reverse diode of transistor is commutated with same device according to figure C. With application relevant values  $I_C \leq 1.5A$ ,  $C_{Snubber} = 1$  nF and  $R_G \geq 50\Omega$ , dv/dt of the reverse diode is within its specification.



# ILA03N60, ILP03N60 ILB03N60, ILD03N60

## Thermal Resistance

Parameter	Symbol	Conditions	Max. Value	Unit
<b>Characteristic</b>				
IGBT thermal resistance, junction – case	$R_{thJC}$	P-TO-220-3-31	7.6	K/W
		Other packages	4.7	
Diode thermal resistance, junction – case	$R_{thJCD}$	TO-220-3-31	12	
		Other packages	10	
Therm. resistance, junction - ambient	$R_{thJA}$	P-TO-220-3-31	65	
		P-TO-220-3-1	62	
SMD version, device on PCB: @ min. footprint @ 6cm <sup>2</sup> cooling area <sup>1</sup> @ min. footprint @ 6cm <sup>2</sup> cooling area <sup>1</sup>	$R_{thJA}$	P-TO-263-3-2	75	
			50	
		P-TO-252-3-1	62	
			40	

## Electrical Characteristic, at $T_j = 25^\circ\text{C}$ , unless otherwise specified

Parameter	Symbol	Conditions	Value			Unit
			min.	typ.	max.	
<b>Static Characteristic</b>						
Collector-emitter breakdown voltage	$V_{(BR)CES}$	$V_{GE}=0V, I_C=0.5mA$	600	-	-	V
Collector-emitter avalanche breakdown voltage	$V_{(BR)CE}$	$V_{GS}=0V; I_C=0.4A$	-	850	-	
Collector-emitter saturation voltage	$V_{CE(sat)}$	$V_{GE}=10V, I_C=3.0A$ $T_j=25^\circ\text{C}$ $T_j=150^\circ\text{C}$	-	2.3	2.9	
			-	2.7		
		$V_{GE}=10V, I_C=0.8A$ $T_j=25^\circ\text{C}$ $T_j=150^\circ\text{C}$	-	1.5	-	
			-	1.5	-	
Diode forward voltage	$V_F$	$V_{GE}=0V, I_F=3.0A$ $T_j=25^\circ\text{C}$ $T_j=150^\circ\text{C}$	-	1.5	1.8	
			-	1.6		
		$V_{GE}=0V, I_F=0.8A$ $T_j=25^\circ\text{C}$ $T_j=150^\circ\text{C}$	-	1.0	-	
			-	1.0	-	
Gate-emitter threshold voltage	$V_{GE(th)}$	$I_C=30\mu A, V_{CE}=V_{GE}$	2.1	3.0	3.9	V

<sup>1</sup> Device on 40mm\*40mm\*1.5mm epoxy PCB FR4 with 6cm<sup>2</sup> (one layer, 70μm thick) copper area for drain connection. PCB is vertical without blown air.



# ILA03N60, ILP03N60 ILB03N60, ILD03N60

## Electrical Characteristic, at $T_j = 25^\circ\text{C}$ , unless otherwise specified continued

Parameter	Symbol	Conditions	Value			Unit
			min.	typ.	max.	
Zero gate voltage collector current	$I_{CES}$	$V_{CE}=600\text{V}, V_{GE}=0\text{V}$ $T_j=25^\circ\text{C}$ $T_j=150^\circ\text{C}$	-	1	20	$\mu\text{A}$
Gate-emitter leakage current	$I_{GES}$	$V_{CE}=0\text{V}, V_{GE}=20\text{V}$	-	-	100	nA
Transconductance	$g_{fs}$	$V_{CE}=20\text{V}, I_C=3.0\text{A}$	-	1.5	-	S

## Capacities, Gate Charge, at $T_j=25^\circ\text{C}$

Parameter	Symbol	Conditions	Value			Unit
			min.	typ.	max.	
Input capacitance	$C_{iss}$	$V_{CE}=25\text{V},$	-	110	-	pF
Output capacitance	$C_{oss}$	$V_{GE}=0\text{V},$	-	6	-	
Reverse transfer capacitance	$C_{rfs}$	$f=1\text{MHz}$	-	4	-	
Effective Output Capacitance (Energy related)	$C_{o(er)}$	$V_{GE}=0\text{V},$ $V_{CE}=0\text{V to }480\text{V}$		3.7		pF
Gate to emitter charge	$Q_{GE}$	$V_{CE}=400\text{V},$	-	1	-	nC
Gate to collector charge	$Q_{GC}$	$I_C=3.0\text{A},$	-	5.5	-	
Gate total charge	$Q_G$	$V_{GE}=10\text{V}$	-	8.5	-	
Gate plateau voltage	$V_m$		-	6.5	-	
Gate to emitter charge	$Q_{GE}$	$V_{CE}=400\text{V},$	-	0.5	-	nC
Gate to collector charge	$Q_{GC}$	$I_C=0.8\text{A},$	-	4.0	-	
Gate total charge	$Q_G$	$V_{GE}=10\text{V}$	-	8	-	
Gate plateau voltage	$V_m$		-	3.5	-	

## Switching Characteristic, Inductive Load, at $T_j=25^\circ\text{C}$

Parameter	Symbol	Conditions	Value			Unit
			min.	typ.	max.	
<b>IGBT Characteristic</b>						
Turn-on delay time	$t_{d(on)}$	$V_{CC}=400\text{V},$	-	15	-	ns
Rise time	$t_r$	$I_C=0.8\text{A},$	-	35	-	
Turn-off delay time	$t_{d(off)}$	$V_{GE}=0/10\text{V},$	-	100	-	
Fall time	$t_f$	$R_G=60\Omega,$ $C_{S\text{nubber}}=0\text{nF}$	-	100	-	
Turn-on energy	$E_{on}^3$	( $C_{S\text{nubber}}$ : Snubber capacitor)	-	12	-	$\mu\text{J}$
Turn-off energy	$E_{off}$		-	20	-	
Turn-off energy	$E_{off}$	$C_{S\text{nubber}}=1\text{nF}$	-	8	-	

<sup>3</sup>  $E_{on}$  includes SDP04S60 diode commutation losses



# ILA03N60, ILP03N60 ILB03N60, ILD03N60

## Switching Characteristic, Inductive Load, at $T_j=150\text{ }^\circ\text{C}$

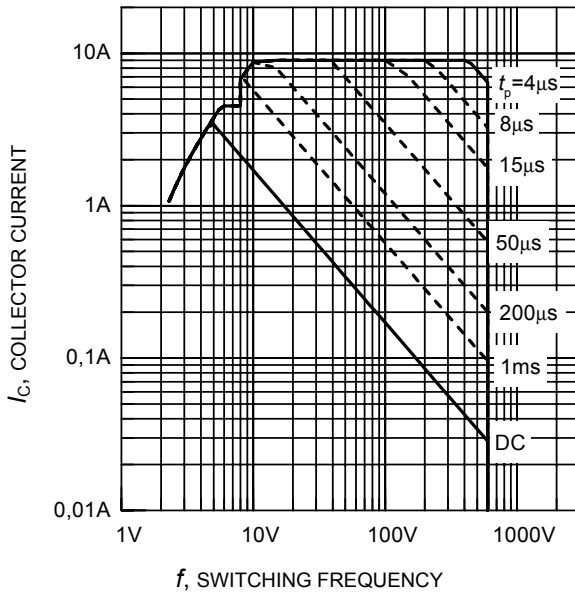
Parameter	Symbol	Conditions	Value			Unit
			min.	typ.	max.	
<b>IGBT Characteristic</b>						
Turn-on delay time	$t_{d(on)}$	$V_{CC}=400V,$ $I_C=0.8A,$ $V_{GE}=0/10V,$ $R_G=60\Omega,$ $C_{Snubber}=0nF$	-	20	-	ns
Rise time	$t_r$		-	45	-	
Turn-off delay time	$t_{d(off)}$		-	120	-	
Fall time	$t_f$		-	120	-	
Turn-on energy	$E_{on}^3$	(C <sub>Snubber</sub> : Snubber capacitor)	-	15	-	$\mu J$
Turn-off energy	$E_{off}$		-	28	-	
Turn-off energy	$E_{off}$	$C_{Snubber} = 1nF$	-	12	-	

## Switching Characteristic, Inductive Load, at $T_j=25\text{ }^\circ\text{C}$

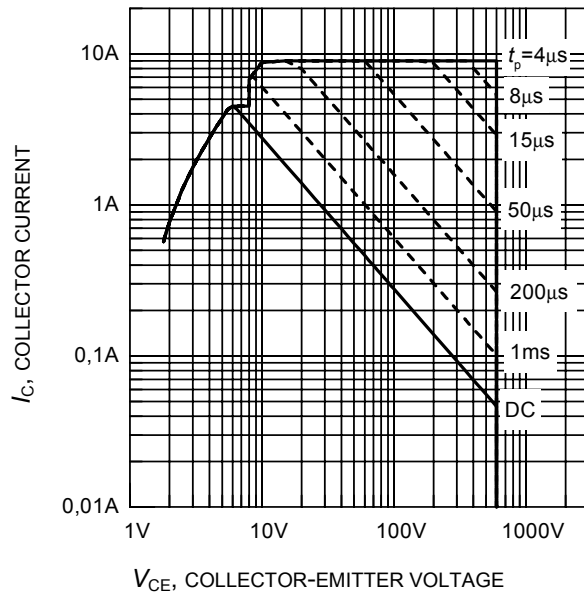
Parameter	Symbol	Conditions	Value			Unit
			min.	typ.	max.	
<b>Reverse diode Characteristic (switching in half bridge configuration with same transistor according to figure C)</b>						
Reverse recovery time	$t_{rr}$	$V_R=400V,$ $I_F=0.8A,$ $V_{GE}=0/10V,$ $R_G=80\Omega$	-	90	-	ns
Reverse recovery charge	$Q_{rr}$		-	0.27	-	$\mu C$
Peak reverse recovery current	$I_{rrm}$		-	5.5	-	A
Peak rate of fall of reverse recovery current	$di_{rr}/dt$		-	300	-	A/ $\mu s$
Reverse recovery time	$t_{rr}$	$V_R=400V,$ $I_F=3A,$ $V_{GE}=0/10V,$ $R_G=80\Omega$	-	250	-	ns
Reverse recovery charge	$Q_{rr}$		-	0.75	-	$\mu C$
Peak reverse recovery current	$I_{rrm}$		-	8	-	A
Peak rate of fall of reverse recovery current	$di_{rr}/dt$		-	300	-	A/ $\mu s$



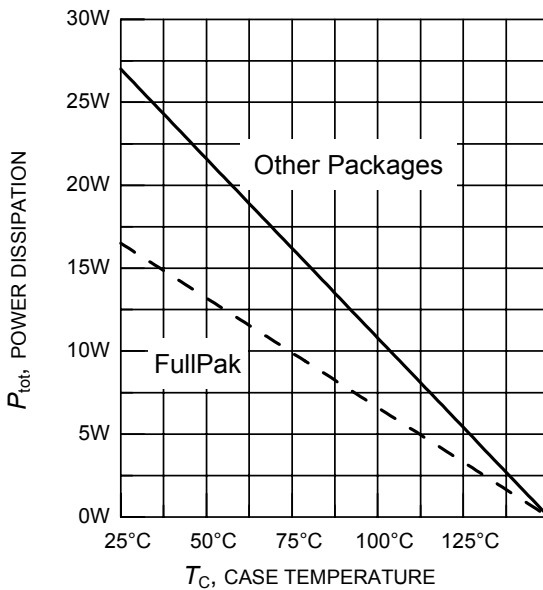
# ILA03N60, ILP03N60 ILB03N60, ILD03N60



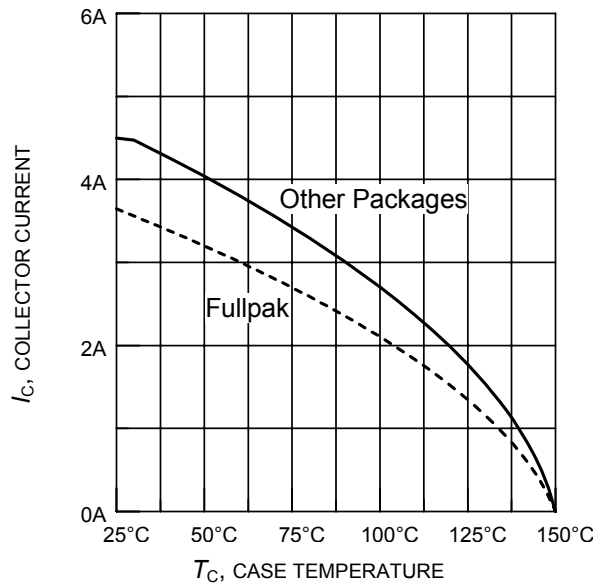
**Figure 1: Safe operating area (FullPak)**  
( $D = 0, T_C = 25^\circ\text{C}, T_j \leq 150^\circ\text{C}$ )



**Figure 2: Safe operating area (Other Packages)**  
( $D = 0, T_C = 25^\circ\text{C}, T_j \leq 150^\circ\text{C}$ )



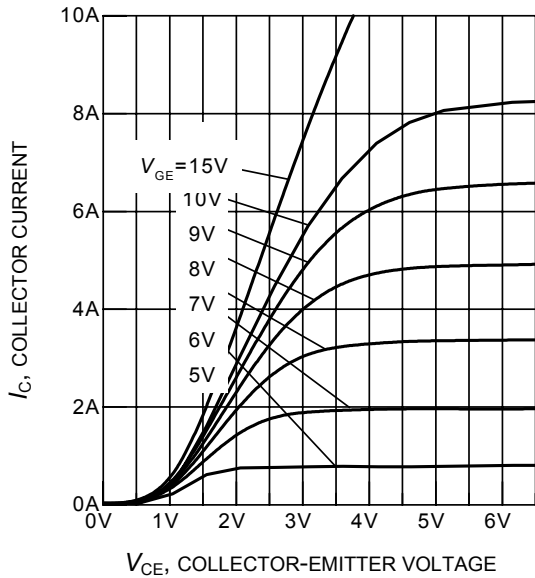
**Figure 3. Power dissipation as a function of case temperature**  
( $T_j \leq 150^\circ\text{C}$ )



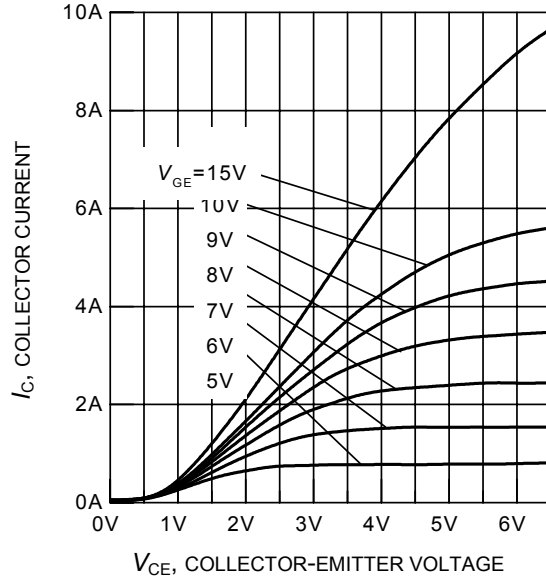
**Figure 4. Collector current as a function of case temperature**  
( $V_{GE} \leq 10\text{V}, T_j \leq 150^\circ\text{C}$ )



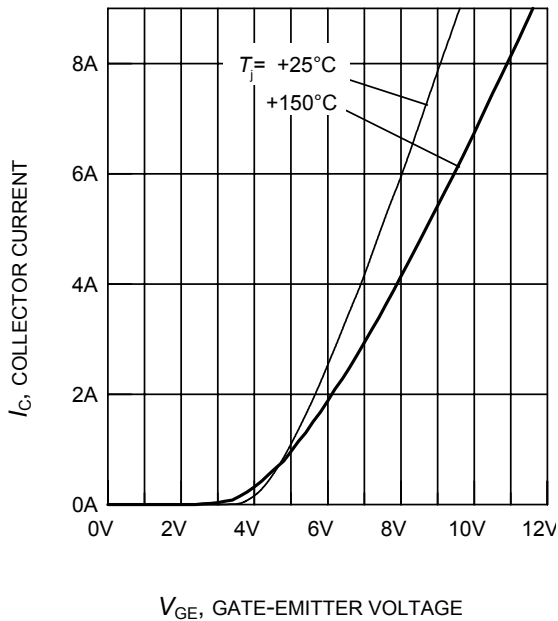
# ILA03N60, ILP03N60 ILB03N60, ILD03N60



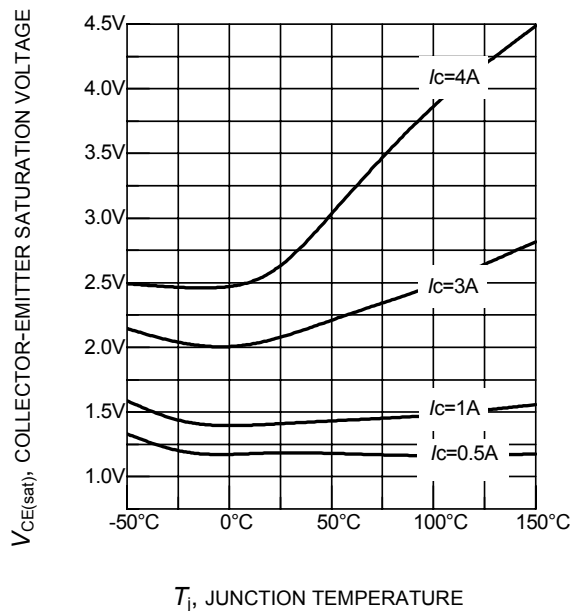
**Figure 5. Typical output characteristics**  
( $T_j = 25^\circ\text{C}$ )



**Figure 6. Typical output characteristics**  
( $T_j = 150^\circ\text{C}$ )



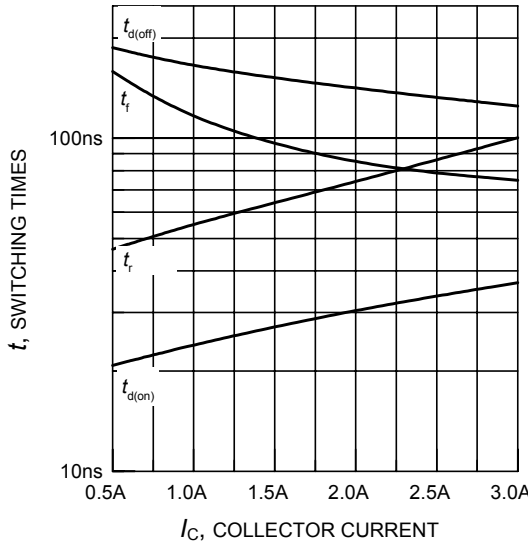
**Figure 7. Typical transfer characteristics**  
( $V_{CE} = 20\text{V}$ )



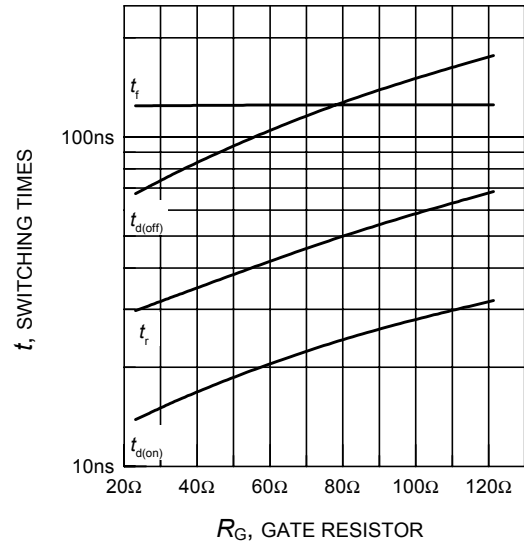
**Figure 8. Typical collector-emitter saturation voltage as a function of junction temperature**  
( $V_{GE} = 10\text{V}$ )



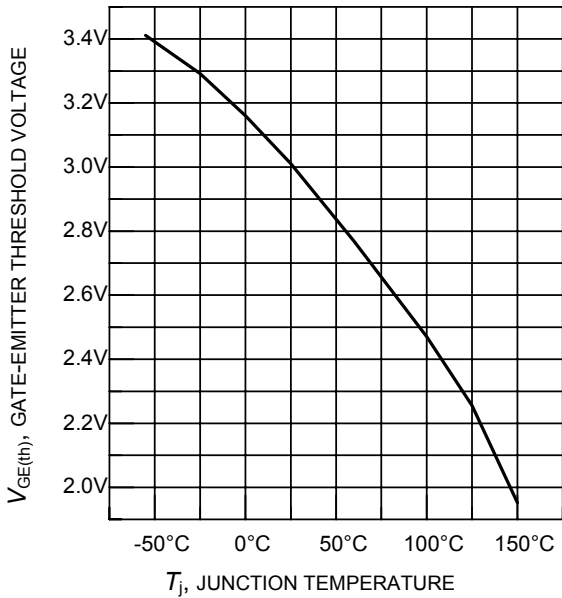
# ILA03N60, ILP03N60 ILB03N60, ILD03N60



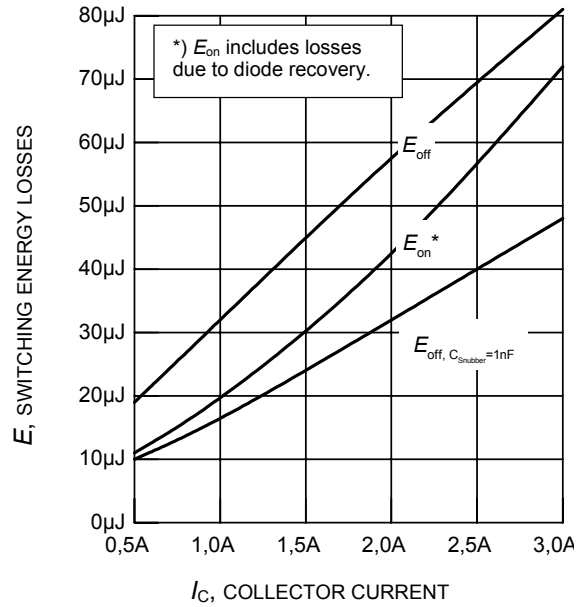
**Figure 9. Typical switching times as a function of collector current**  
(inductive load,  $T_j = 150^\circ\text{C}$ ,  $V_{CE} = 400\text{V}$ ,  $V_{GE} = 0/+10\text{V}$ ,  $R_G = 80\Omega$ , Dynamic test circuit in Figure E)



**Figure 10. Typical switching times as a function of gate resistor**  
(inductive load,  $T_j = 150^\circ\text{C}$ ,  $V_{CE} = 400\text{V}$ ,  $V_{GE} = 0/+10\text{V}$ ,  $I_C = 1\text{A}$ , Dynamic test circuit in Figure E)



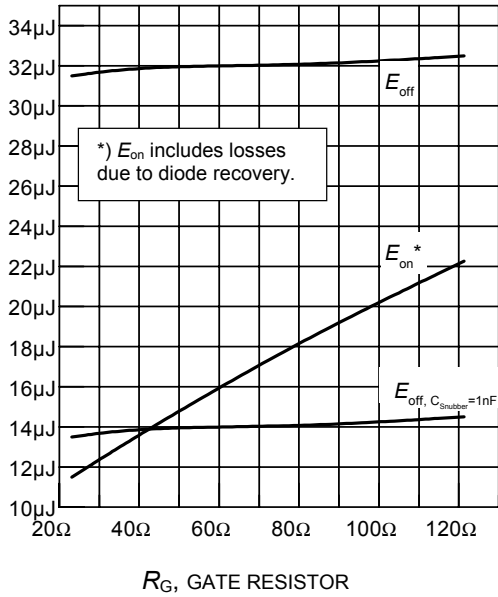
**Figure 12. Gate-emitter threshold voltage as a function of junction temperature**  
( $I_C = 30\mu\text{A}$ )



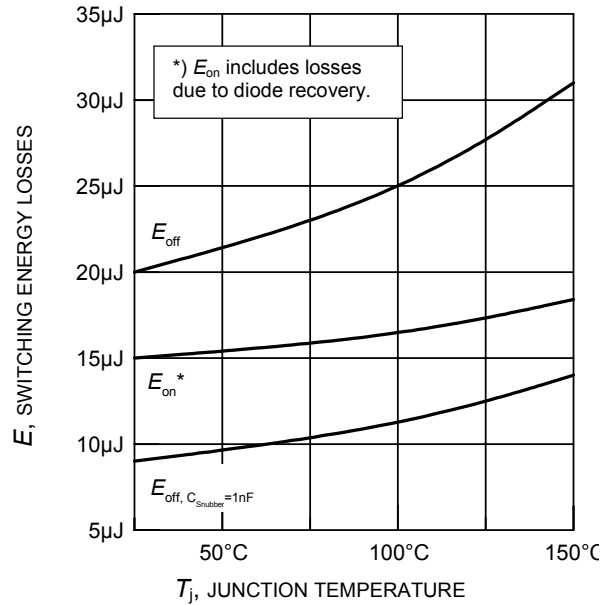
**Figure 13. Typical switching energy losses as a function of collector current**  
(inductive load,  $T_j = 150^\circ\text{C}$ ,  $V_{CE} = 400\text{V}$ ,  $V_{GE} = 0/+10\text{V}$ ,  $R_G = 80\Omega$ ,  $C_{Snubber} = 0/1\text{nF}$  Dynamic test circuit in Figure E)



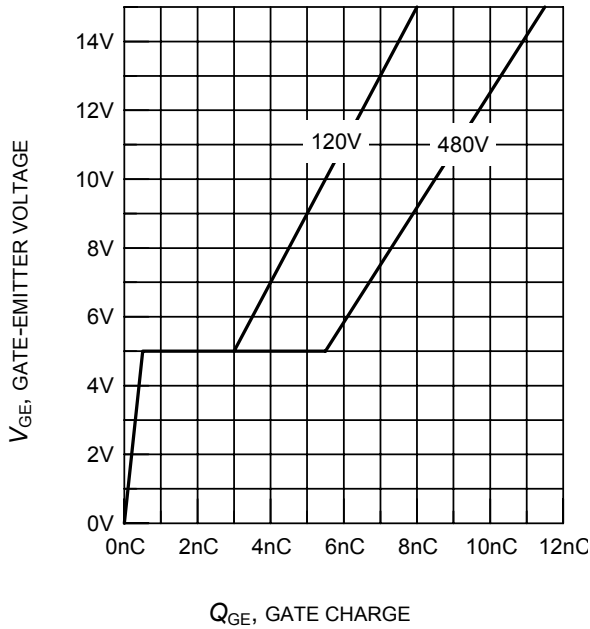
# ILA03N60, ILP03N60 ILB03N60, ILD03N60



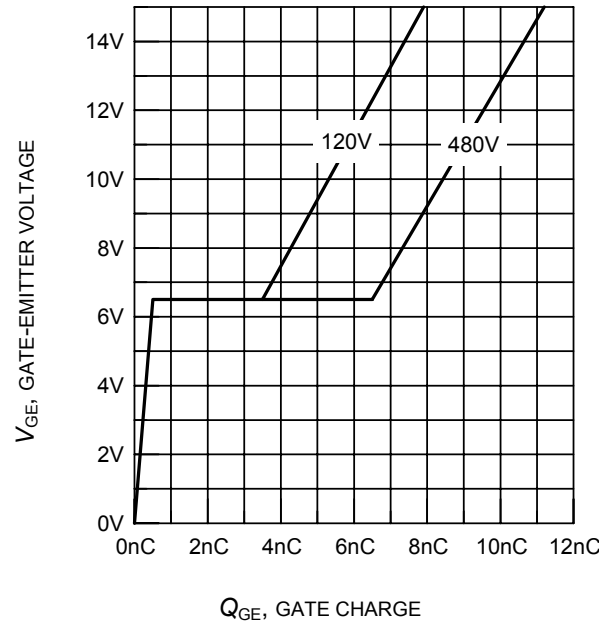
**Figure 14. Typical switching energy losses as a function of gate resistor**  
(inductive load,  $T_j = 150^\circ\text{C}$ ,  $V_{CE} = 400\text{V}$ ,  $V_{GE} = 0/+10\text{V}$ ,  $I_C = 1\text{A}$ ,  $C_{Snubber}=0/1\text{nF}$   
Dynamic test circuit in Figure E)



**Figure 15. Typical switching energy losses as a function of junction temperature**  
(inductive load,  $V_{CE} = 400\text{V}$ ,  $V_{GE} = 0/+10\text{V}$ ,  $I_C = 1\text{A}$ ,  $R_G = 80\Omega$ ,  $C_{Snubber}=0/1\text{nF}$   
Dynamic test circuit in Figure E)

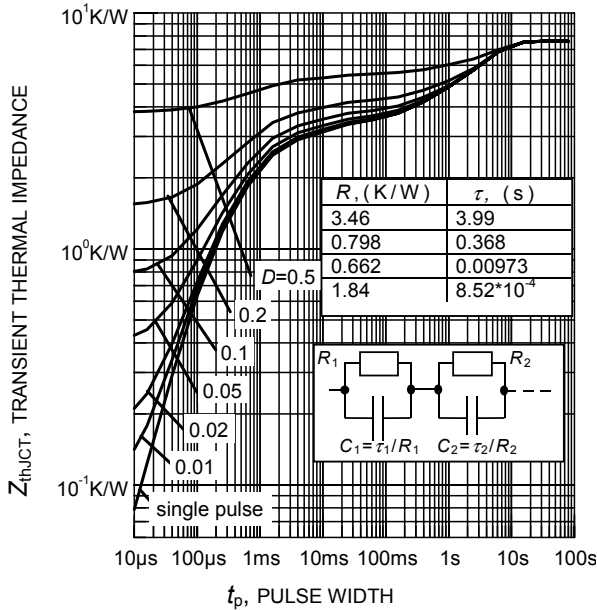


**Figure 16. Typical gate charge**  
( $I_C = 0.8\text{A}$ )

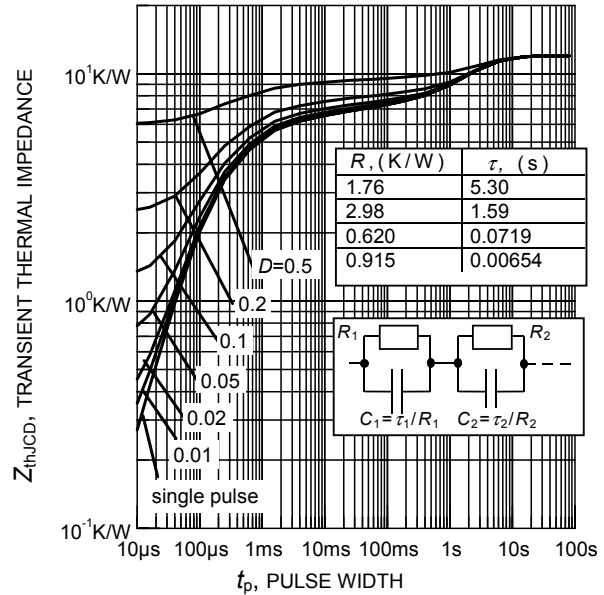


**Figure 17. Typical gate charge**  
( $I_C = 3\text{A}$ )

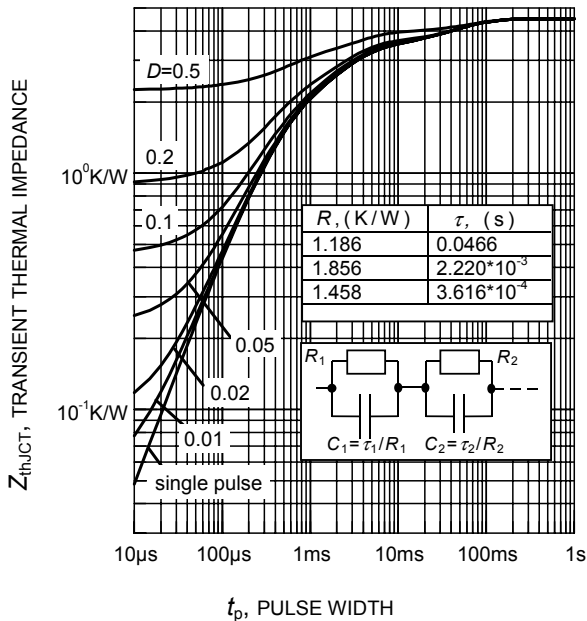




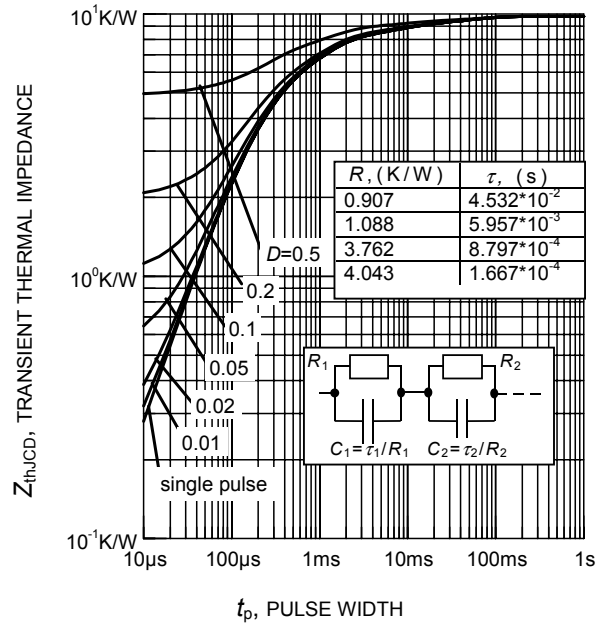
**Figure 18: IGBT transient thermal impedance as a function of pulse width (FullPak)**  
( $D = t_p / T$ )



**Figure 19: Diode transient thermal impedance as a function of pulse width (FullPak)**  
( $D = t_p / T$ )



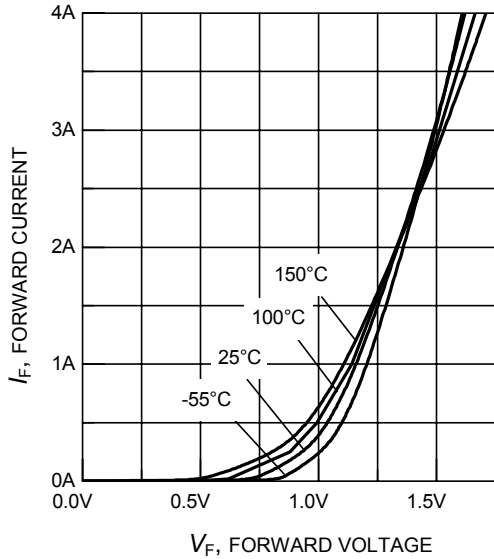
**Figure 20: IGBT transient thermal impedance as a function of pulse width (Other Packages)**  
( $D = t_p / T$ )



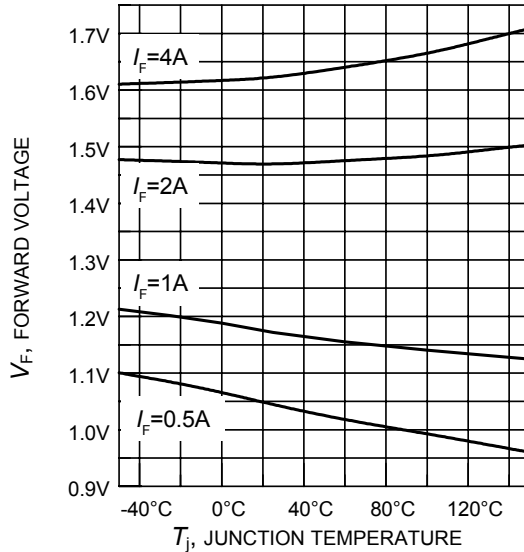
**Figure 21: Diode transient thermal impedance as a function of pulse width (Other Packages)**  
( $D = t_p / T$ )



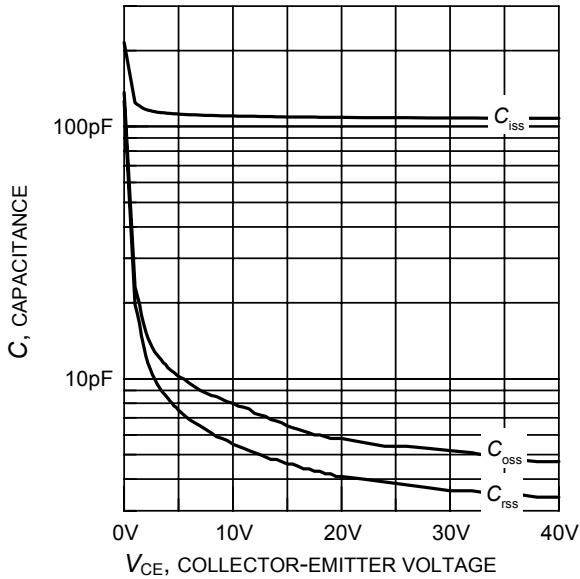
# ILA03N60, ILP03N60 ILB03N60, ILD03N60



**Figure 20. Typical diode forward current as a function of forward voltage**



**Figure 21. Typical diode forward voltage as a function of junction temperature**



**Figure 19. Typical capacitance as a function of collector-emitter voltage**  
( $V_{GE} = 0V, f = 1MHz$ )

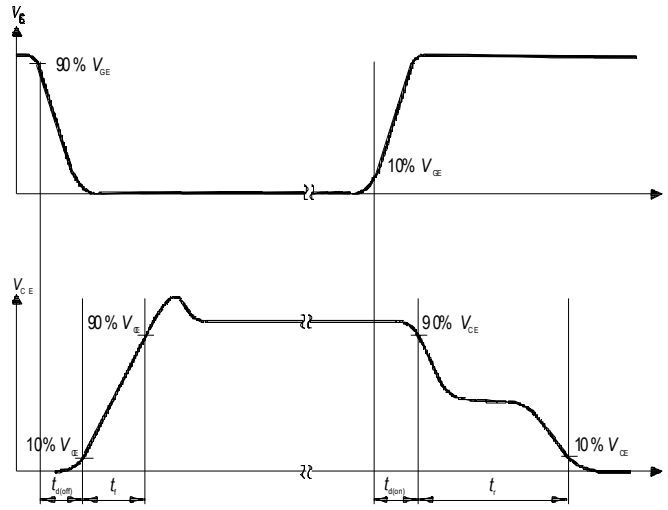


Figure A. Definition of switching times

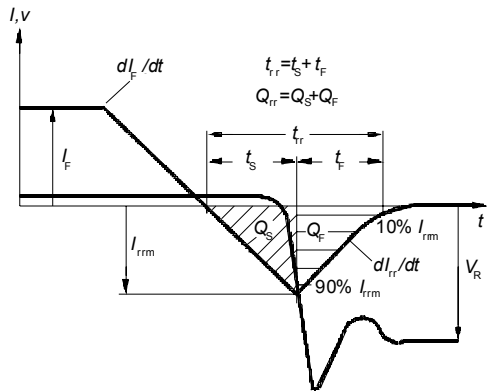


Figure B. Definition of diodes switching characteristics

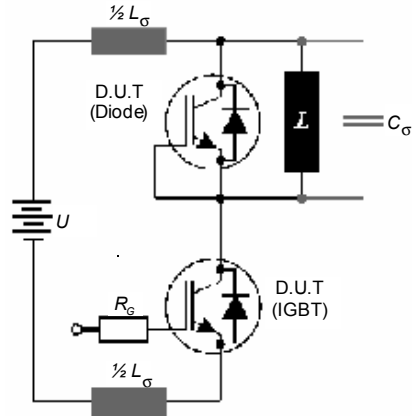
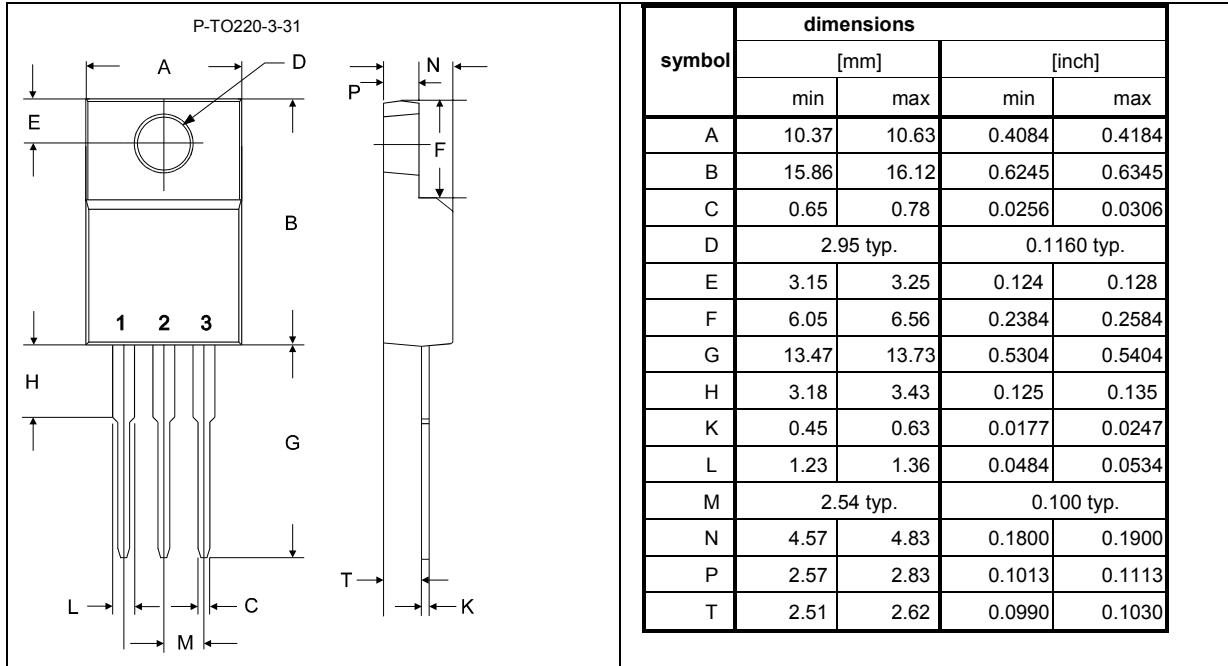


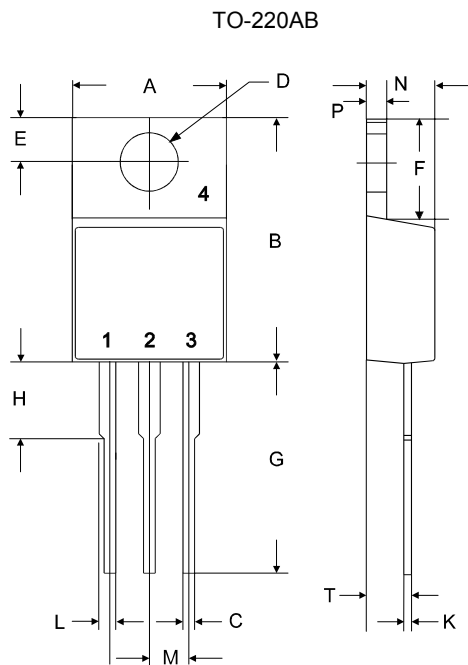
Figure C. Dynamic test circuit



# ILA03N60, ILP03N60 ILB03N60, ILD03N60



Please refer to mounting instructions (application note AN-TO220-3-31-01)

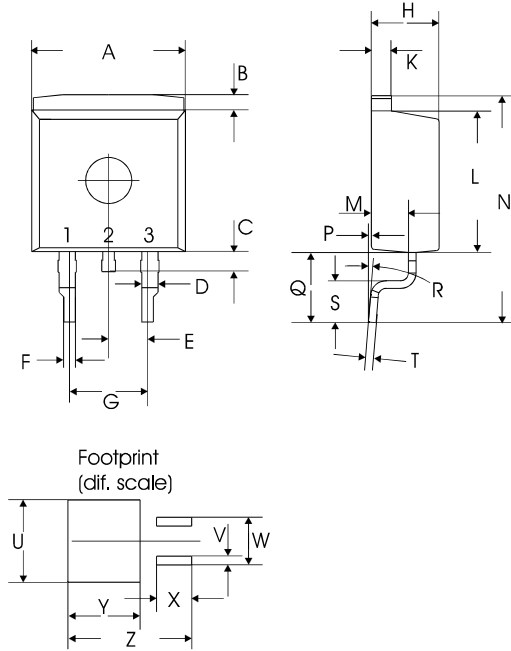


symbol	dimensions			
	[mm]		[inch]	
	min	max	min	max
A	9.70	10.30	0.3819	0.4055
B	14.88	15.95	0.5858	0.6280
C	0.65	0.86	0.0256	0.0339
D	3.55	3.89	0.1398	0.1531
E	2.60	3.00	0.1024	0.1181
F	6.00	6.80	0.2362	0.2677
G	13.00	14.00	0.5118	0.5512
H	4.35	4.75	0.1713	0.1870
K	0.38	0.65	0.0150	0.0256
L	0.95	1.32	0.0374	0.0520
M	2.54 typ.		0.1 typ.	
N	4.30	4.50	0.1693	0.1772
P	1.17	1.40	0.0461	0.0551
T	2.30	2.72	0.0906	0.1071



# ILA03N60, ILP03N60 ILB03N60, ILD03N60

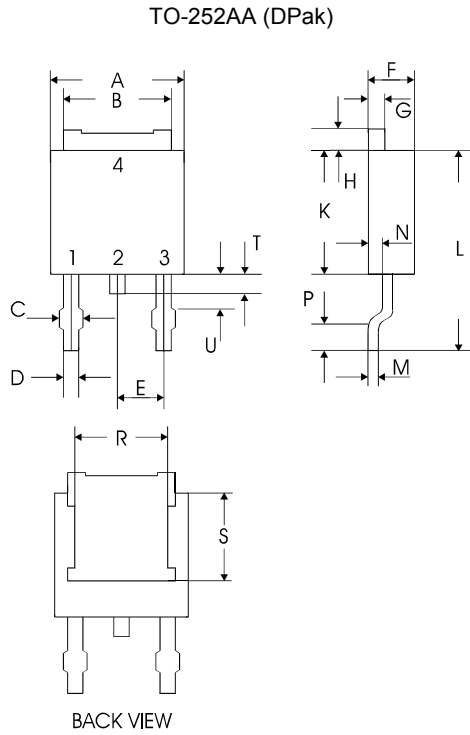
TO-263AB (D<sup>2</sup>Pak)



symbol	dimensions			
	[mm]		[inch]	
	min	max	min	max
A	9.80	10.20	0.3858	0.4016
B	0.70	1.30	0.0276	0.0512
C	1.00	1.60	0.0394	0.0630
D	1.03	1.07	0.0406	0.0421
E	2.54 typ.		0.1 typ.	
F	0.65	0.85	0.0256	0.0335
G	5.08 typ.		0.2 typ.	
H	4.30	4.50	0.1693	0.1772
K	1.17	1.37	0.0461	0.0539
L	9.05	9.45	0.3563	0.3720
M	2.30	2.50	0.0906	0.0984
N	15 typ.		0.5906 typ.	
P	0.00	0.20	0.0000	0.0079
Q	4.20	5.20	0.1654	0.2047
R	8° max		8° max	
S	2.40	3.00	0.0945	0.1181
T	0.40	0.60	0.0157	0.0236
U	10.80		0.4252	
V	1.15		0.0453	
W	6.23		0.2453	
X	4.60		0.1811	
Y	9.40		0.3701	
Z	16.15		0.6358	



# ILA03N60, ILP03N60 ILB03N60, ILD03N60



symbol	dimensions			
	[mm]		symbol	
	min		min	
A	6.40	A	6.40	A
B	5.25	B	5.25	B
C	(0.65)	C	(0.65)	C
D	0.63	D	0.63	D
E	2.28		E	
F	2.19	F	2.19	F
G	0.76	G	0.76	G
H	0.90	H	0.90	H
K	5.97	K	5.97	K
L	9.40	L	9.40	L
M	0.46	M	0.46	M
N	0.87	N	0.87	N
P	0.51	P	0.51	P
R	5.00	R	5.00	R
S	4.17	S	4.17	S
T	0.26	T	0.26	T
U	-	U	-	U



# ILA03N60, ILP03N60 ILB03N60, ILD03N60

---

**Published by**  
**Infineon Technologies AG,**  
**Bereich Kommunikation**  
**St.-Martin-Strasse 53,**  
**D-81541 München**  
**© Infineon Technologies AG 2003**  
**All Rights Reserved.**

## **Attention please!**

The information herein is given to describe certain components and shall not be considered as warranted characteristics.

Terms of delivery and rights to technical change reserved.

We hereby disclaim any and all warranties, including but not limited to warranties of non-infringement, regarding circuits, descriptions and charts stated herein.

Infineon Technologies is an approved CECC manufacturer.

## **Information**

For further information on technology, delivery terms and conditions and prices please contact your nearest Infineon Technologies Office in Germany or our Infineon Technologies Representatives worldwide (see address list).

## **Warnings**

Due to technical requirements components may contain dangerous substances. For information on the types in question please contact your nearest Infineon Technologies Office.

Infineon Technologies Components may only be used in life-support devices or systems with the express written approval of Infineon Technologies, if a failure of such components can reasonably be expected to cause the failure of that life-support device or system, or to affect the safety or effectiveness of that device or system. Life support devices or systems are intended to be implanted in the human body, or to support and/or maintain and sustain and/or protect human life. If they fail, it is reasonable to assume that the health of the user or other persons may be endangered.